

625.1
VIC
Y.I.

ADMISSION OF VIC

6 JUL 1950

"The Door to Success"

VICTORIAN RAILWAYS INSTITUTE

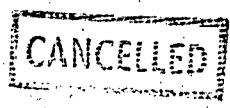
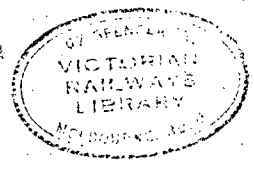
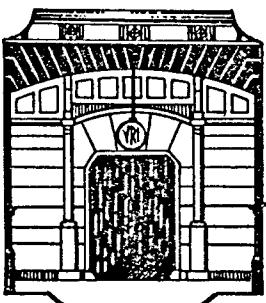

PERMANENT WAY
CORRESPONDENCE COURSE

BOOK 1
SECTIONS 1 - 12

1947

SECTIONS.

			Page
1.	INTRODUCTION	1
2.	TERMS & DEFINITIONS	..	3
3.	PERMANENT WAY	8
4.	SIGNS & STRUCTURES	..	55
5.	EARTHWORKS	74
6.	DRAINAGE	87
7.	BALLAST	103
8.	SLEEPERS	109
9.	RAILS	125
10.	TRACK FASTENINGS..	..	161
11.	TRACK MAINTENANCE.	..	203
12.	RELAYING TRACK	261

TABLE OF CONTENTS.

	Page	Sec.		Page	Sec.
<u>SECTION 1</u>			<u>SECTION (3 cont)</u>		
<u>INTRODUCTION</u>	1		Momentum Grade	29	3.22
<u>SECTION 2</u>			Gravitation		
<u>TERMS & DEFINITIONS</u>	3		Grade	"	"
<u>SECTION 3</u>			Levels	"	"
<u>PERMANENT WAY</u>			Vertical Curves	"	"
Definitions	8	3.01	Curve Compensation.	31	3.24
Cross Section	"	"	Clearance	32	3.25
Effects of Traffic	"	"	Curvature	"	"
Track Wave	10	3.03	Curving Rails	33	3.26
Creep	12	3.05	Table. Standard		
Straight Track	13	3.06	Sleeper Spacing	35	3.28
Runouts	"	"	<u>SECTION 4</u>		
Curved Track	"	"	<u>SIGNS & STRUCTURES</u>		
Types of Curves	14	3.07	Purpose	55	4.01
Compound Curves	"	"	Track Signs	"	"
Reverse Curves	"	"	Mile Posts	"	"
Transition Curves	15	3.08	Grade Boards	"	"
Cubic Parabola	"	"	Gang Posts	"	"
Curve Pegs	17	3.10	Whistle Posts	"	"
Cant	18	3.11	Speed Boards	56	4.02
Equilibrium Cant	19	3.12	Foot Crossing		
Standard Cant	20	3.13	Signs	"	"
Grade Rail	21	3.14	Trespass Boards	"	"
Cant Runouts	"	"	Level Crossing		
Curve Wear	"	"	Signs	"	"
Spreading of Gauge	"	"	Wig Wag Sign	"	"
Position of Wheels	22	3.15	Flashing Light		
Rail Head Flow	23	3.16	Sign	"	"
Effect of Wheel			Warning and Caution		
Base	"	"	Signals	57	4.03
Angle of Approach	"	"	Series Parallel		
Widening of Gauge	24	3.17	Indicators	"	"
Check Rails on			Indicator Boards	58	4.04
Curves	"	"	Valve Boards	"	"
Double Check Rails	25	3.18	Ash Dump Boards	"	"
Check Rail Flange-			Permanent Markings	"	"
ways	"	"	Structures	59	4.05
Running Clearance	26	3.19	Buffer Stops	"	"
Guard Rails	"	"	Cattle Pits	"	"
Overlap of Guard			Fences	60	4.06
Rails	27	3.20	Level Crossings	"	"
Conductivity Rails	"	"	Bridges	"	"
Curve Resistance	"	"	Subways	"	"
Track Lubrication	"	"	Flood Openings	61	4.07
Grade	28	3.21	Culverts	"	"
Ruling Grade	29	3.22			

	<u>Page</u>	<u>Sec.</u>		<u>Page</u>	<u>Sec.</u>
<u>SECTION 5</u>			<u>SECTION 6</u>		
<u>EARTHWORKS</u>			<u>DRAINAGE (cont)</u>		
General	74	5.01	Waterways	94	6.08
Longitudinal Section	"	"	Catchment Drains	"	"
Cuttings	"	"	Lateral Drains	"	"
Tunnels	75	5.02	Diversion Drains	95	6.09
Embankments	76	5.03	Outfalls	"	"
Reservoir Embank- ments	78	5.05	Cut-off Gates	"	"
Borrow Pits	"	"	Sewerage Outfalls	"	"
Side Cuttings	"	"	Diversion of Water	"	"
Excavation	79	5.06	Pit Drainage	96	6.10
Forming & Grading	"	"	<u>SECTION 7</u>		
Volume of loose Spoil	"	"	<u>BALLAST</u>		
Slopes	80	5.07	Purpose	103	7.01
Transport of Spoil	"	"	Essential Functions	"	"
Barrow & Plank	"	"	Qualities	"	"
Drays	"	"	Basalt	104	7.02
Skid Scoops	81	5.08	Quartz	"	"
Wheeled Scoops	"	"	Granite	105	7.03
			Sandstones	"	"
			Shales & Slates	"	"
			Limestones	"	"
			Gravels	"	"
			Ashes	106	7.04
			Scoria	"	"
			Sand or Loamy Sand	"	"
			General	107	7.05
			Acidity	108	7.06
<u>SECTION 5</u>			<u>SECTION 8</u>		
<u>DRAINAGE</u>			<u>SLEEPERS</u>		
Purpose	87	6.01	Purpose	109	8.01
Classification	"	"	Steel Sleepers	"	"
Surface Drains	"	"	Concrete Sleepers	110	8.02
Subsidiary Sur- face Drains	88	6.02	Cast Iron Pot Sleepers	"	"
Cess Drains	"	"	Timber Sleepers	"	"
Cross Drains	89	6.03	Sleeper Life	111	8.03
Face Drains	"	"	Rail Cut Sleepers	"	"
Underground Drains	90	6.04	Spike Killed Sleepers	"	"
Seepage	"	"	Broken Sleepers	112	8.04
Water Pockets	91	6.05	Split Sleepers	"	"
Surface Forma- tions	"	"	Destruction by Fire	"	"
Deep Cutting Formations	"	"	Decay	"	"
Shallow Cutting Formations	"	"	Preservation	113	8.05
Embankment Formations	92	6.06	Chemical Preservation	"	"
Pumping	"	"			
Spot Grouting	93	6.07			
P. C. R. Crossing Drainage	"	"			

	<u>Page</u>	<u>Sec.</u>		<u>Page</u>	<u>Sec.</u>
<u>SECTION 8</u>			<u>SECTION 9</u>		
<u>SLEEPERS (cont)</u>			<u>RAILS (cont)</u>		
Mechanical Preservation	114	8.06	Crushed Heads	140	9.16
Classification	"	"	Corrugated Rails	"	"
Stacking	115	8.07	Roaring Rails	"	"
Adzing	"	"	Crippled Rails	141	9.17
Boring	"	"	Corrosion	"	"
General	116	8.08	Expansion	142	9.18
			Anchoring	"	"
			Contraction	143	9.19
			Tables of Rails	144	9.20
<u>SECTION 9</u>			<u>SECTION 10</u>		
<u>RAILS</u>			<u>TRACK FASTENINGS</u>		
Purpose	125	9.01	Dogspikes	161	10.01
Qualities	"	"	Elastic Spikes	163	10.03
Types of Rails	126	9.02	Rail Pins	"	"
Iron Rails	"	"	Mechanical Rail	"	"
Steel Rails	"	"	Joints	"	"
Special Types	127	9.03	Junction Joints	164	10.04
Tramway Rails	"	"	Junction Rails	166	10.06
Dimensions	"	"	Repair Fishplates	"	"
Section	128	9.04	Insulated Joints	167	10.07
Weight	"	"	Fishbolts	168	10.08
Length	"	"	Spring Washers	"	"
Tolerances	"	"	Sleeper Plates	169	10.09
Rail Brands	129	9.05	Bridge Plates	170	10.10
Heat Numbers	"	"	Special Track	"	"
Rail Joints	130	9.06	Plates	"	"
Welded Rail	"	"	Anchor Straps	171	10.11
Thermit Welds	132	9.08	Rail Anchors	"	"
Combined Weld	"	"	Tables	"	"
Fusion Weld	"	"	Fishplates	172	10.12
Flash Butt Weld	"	"	Junction Fish-	"	"
Rail Steel	133	9.09	plates	176	10.16
Rail Defects	135	9.11	Insulated	"	"
Piped Rails	136	9.12	Joints	177	10.17
Split Rails	"	"	Fishbolts	178	10.18
Transverse	"	"	Junction Fish-	"	"
Fissures	"	"	bolts	182	10.22
Flange Cracks	137	9.13	Insulated Joint	"	"
Web Cracks	"	"	Bolts	184	10.24
Fillet Cracks	138	9.14			
Head Cracks	"	"			
Welding Cracks	"	"			
Rail Burns	139	9.15			
Wear and Deformation	"	"	<u>SECTION 11</u>		
Head Flow	"	"	<u>TRACK MAINTENANCE</u>		
Scabby Rails	"	"	Definition	203	11.01
			Surfacing Track	"	"

	<u>Page</u>	<u>Sec.</u>
<u>SECTION 11</u>		
<u>TRACK MAINTENANCE</u>		
(cont)		
Grade Rail	203	11.01
Lifting Track	204	11.02
Runouts	205	11.03
Spot Surfacing	206	11.04
Out-of-face Surfacing	"	"
Centre Bound Track	207	11.05
Voidmeters	"	"
Measured Packing	208	11.06
Shovel Packing	209	11.07
Beater Packing	"	"
Mechanical Packing	"	"
Joint Packing	210	11.08
Alignment	"	"
Aligning Rail	211	11.09
Lining Operations	"	"
Lining Straight Track	212	11.10
Lining Curved Track	213	11.11
String Lining	"	"
Gauging Track	214	11.12
Surfacing Details	215	11.13
Patching	"	"
Strengthening Track	216	11.14
Lifting Limita- tions	"	"
Boxing Up	217	11.15
Sleeper Damage	"	"
Sleeper Renewals	219	11.17
Spiking	220	11.18
Joint Maintenance	222	11.20
Rail Maintenance	224	11.22
Lining out of a Buckle	225	11.23
Hallade Track Recorder	226	11.24
The Instrument	227	11.25
Pendulums	"	"
The Chart	228	11.26
Summary of Letters	"	"
Location Line	229	11.27

	<u>Page</u>	<u>Sec.</u>
<u>SECTION 11</u>		
<u>TRACK MAINTENANCE</u>		
(cont)		
Hallade Track Recorder		
Curve Line	230	11.28
Rolling Line	"	"
Lurching Line	232	11.30
Bouncing Line	241	11.39
General	243	11.41
Weeding	244	11.42
Mechanical Weeding	"	"
The Disc Weeder	245	11.43
Chemical Eradica- tion	"	"
Chipping	246	11.44
Hallade Memoran- dum	247	11.45
<u>SECTION 12</u>		
<u>RELAYING TRACK</u>		
Definition	261	12.01
Adzing	"	"
Related Work	262	12.02
Preparatory Work	263	12.03
Complementary Work	264	12.04
Adjusting Expan- sion	265	12.05
Anchorage Strengthening Track	"	"
Laying Rails	267	12.07
Expansion Spaces	"	"
Shortening Rails on Curves	"	"
Long Welded Rails	268	12.08
Mill Length Rails	269	12.09
Relaying Gangs	271	12.11
Organization	"	"
Method	"	"
Equipment	272	12.12
Instruction	"	"
Quotations from 'Camp'	273	12.13

INTRODUCTION. I.

For many years thoughtful and ambitious trackmen have availed themselves of this Course to increase their knowledge of trackwork and to improve their positions.

The list of past students contains the names of many past and present Permanent Way Officers and the same opportunities exist for present and future students to study and qualify for promotion.

The purpose of the Course is to cover in handy form for study and reference the many phases in construction and maintenance pertaining to Victorian Railway Permanent Way.

In the preparation of the Course every care has been taken to ensure that it accurately covers the standards and practices of the Department at the date of publication.

It will be understood that local conditions and emergencies may warrant a departure from general procedure and that fixed methods cannot be laid down to meet every such contingency.

Generally the successful trackman is one who combines a knowledge of trackwork standards with practical experience and the ability to apply approved methods to unusual problems.

It is of first importance for a student to be thoroughly interested in the subject, and also very necessary for him to observe closely during the day's work, the materials, arrangements and operations described in the Course.

The question papers are designed to make the student think, and the answers may frequently be more apparent on the job than in the text book.

When the answer is clearly in mind it should be put in words on a sheet of scrap paper and then read over by the student who should act as his own examiner and satisfy himself that his answer really conveys his ideas and that, so far as his ability enables him, it is properly worded.

Finally the answer should be written clearly in the student's own style on the answer sheet. The sheets should be enclosed in the envelope provided and forwarded by train to the General Secretary, Victorian Railways Institute, Flinders Street Station Buildings, Melbourne.

Any difficulties in answering the questions should be referred to the Instructor for assistance; the enquiries should be written on a separate sheet of paper and enclosed with the answer sheet.

It is the aim of the Institute to place at the student's disposal the most complete information on the subject, and the co-operation of the students in working with the Instructor in accordance with his corrections and comments will greatly assist in achieving this objective.

Examinations are held at the end of each year and the records of successful students are forwarded to the Chief Civil Engineer and are entered in the departmental records.

Certificates are issued by the Institute to students who pass the annual examinations.

As a large amount of work is involved in checking and correcting the answer sheets, it is desirable that students retain these sheets for future reference, and to assist in this regard the Institute provides special perforated paper on which answers should be written, and a special folder to permit of the answer sheets being put together in book form.

Additional data sheets will be issued from time to time to cover essential amendments in the text of the Course, and these sheets will be designed to permit of their insertion in the folder.

-In conclusion, students' attention is directed to the other Courses conducted by the Institute, and Permanent Way men are advised to take up the Safe Working Course which includes information on departmental forms and duties of trackmen and their immediate supervisors.

Nothing in the Institute Course is to be taken or construed as countermanding or suspending the instructions in the Way and Works Book of Instructions or other departmental instructions all of which should be read in conjunction with this Course.

TERMS & DEFINITIONS. 2.

The terms used to describe arrangements and operations in respect to the Permanent Way differ according to the Railway systems concerned. Many of the terms in common use in Victoria are derived from British Railway practice, but of recent years, owing to the adoption of some American Railway standards, the appropriate American terms have become commonplace.

There are also terms which have been adopted to describe arrangements and operations in the Victorian Railways, but which are not in use on other railway systems.

As reference to these terms will be made throughout the Course, as well as in everyday work, it is important that the principle terms be defined to avoid confusion.

PERMANENT WAY consists of the earthworks, drainage, structures, track and trackwork completed to clearance, grade and alignment in readiness for traffic.

TRACK consists of rails, sleepers, fastenings, and ballast laid on the formation, in continuity, to line and grade.

TRACKWORK is any arrangement of points and crossings with timbers and fastenings laid, lined, surfaced and connected with the track.

FORMATION is the formed and graded earth surface on which the ballast is laid.

SURFACE is the plane of the track and trackwork with reference to the graded longitudinal section.

ALIGNMENT is the direction of track in respect to the correct location of tangents and curves.

CANT is the vertical distance of the outer rail above the inner rail on curved tracks.

GAUGE is the distance between running edges measured $\frac{5}{8}$ " below the running surface.

RUNNING RAILS are rails forming the path for railway traffic.

RUNNING SURFACE is the top surface of the rail head in contact with the wheel treads.

RUNNING EDGE is the side of the rail head in contact with the wheel flanges.

RAIL INCLINATION is the angle at which the running rails are inclined from the vertical towards the track centre line and equal to a slope of 1 in 20.

RAIL LEVEL is the level of the running surfaces of both rails in a straight track, and the level of the running surface of the inner rail on curved track.

CROSS LEVEL is the relation of the running surface of the rails in a track when compared with true level or with cant.

FIVE FOOT is a term used to identify the distance between the rails of the track.

SIX FOOT is a term used to distinguish the distance between the rails of adjacent tracks.

CLEARANCE is the horizontal distance measured between track centre lines or from track centre line to adjacent structures.

STANDING ROOM is the distance measured between points of minimum allowable clearance or inside the catch points in sidings.

HEAD ROOM is the vertical distance between rail level and the underside of overway structures.

STRUCTURE GAUGE is the outline in relation to rail level and centre line of track and within which no part of any structure is permitted to encroach.

ROLLING STOCK GAUGE is the outline relative to rail level and track centre line beyond which no part of any vehicle is permitted to project.

LOADING GAUGE is an outline beyond which loading cannot be effected without special permission.

JOINTS are a mechanical assembly of fishplates, fishbolts, nuts and spring washers arranged to connect rail ends and afford support for the passage of railway traffic.

INSULATED JOINTS are a mechanical assembly of fishplates, insulating channels, ferrules and end posts held in position by special bolts with nuts and washers, and designed to arrest the flow of electric current as well as to unite and support the rails under traffic.

BONDED JOINTS are metallic connections at rail joints to provide a continuous metallic path for the passage of electric currents.

JUNCTION FISHPLATES are the joint arrangements provided to connect and support rails of different sections.

JUNCTION INSULATED JOINTS are the insulated joint arrangements provided to insulate and support rails of different sections.

POINTS are an assembly of switches, stock rails, fastenings and timbers laid to gauge, surface and alignment, connected to trackwork and provided with operating mechanism.

SWITCHES (Tongue Rails or Point Blades), are tapered movable rails arranged to divert traffic from one track to another.

STOCK RAILS are the running rails against which the switches operate.

SWITCH TOE is the fine point at the extremity of the switches

SWITCH HEEL is that end of the switch having a full rail section.

THROW is the horizontal distance through which the switches are moved between normal and reverse measured at the toe.

HEEL SPREAD is the horizontal distance between the gauge sides of the switch and its stock rail measured at the heel of the switch.

CROSSINGS are trackwork structures arranged to provide the necessary flangeways to enable the wheel flanges to pass across the running rails at their intersection.

CROSSING GUARD RAILS are prepared rails laid parallel with and adjacent to running rails to control the lateral position and give direction to the movement of wheels thereby preventing them from striking the noses of crossings.

CONTINUOUS GUARD RAILS are safety rails laid within the gauge parallel with the running rails to control the passage of derailed wheels.

CHECK RAILS are laid, when required, parallel and adjacent to running rails to contact the backs of wheel flanges and thereby reduce the side wear on the opposite running rails.

The term 'Check Rail' has been standardised in England and 'Guard Rail' in America for all rails laid within the gauge to check or control the position and direction of wheel flanges.

FLANGEWAY is the space between the running rail and a guard rail or check rail to provide clearance for the passage of wheel flanges.

FLARE is a tapered widening at the ends of flangeways to gradually engage wheel flanges and draw them into position to pass through flangeways.

GUARD EDGE is the side of the guard rail head in contact with the backs of wheel flanges.

GUARD RAIL GAUGE is the distance across the gauge from the guard edge to the running edge of the opposite rail.

DOUBLE CHECK GAUGE is the distance between the guard edges of double check rails.

TURNOUTS are trackwork arrangements installed to permit traffic to pass from one track to another.

CROSSOVERS consist of two turnouts arranged to connect adjacent tracks.

DIAMONDS consist of four crossings, two 'V' crossings and two 'K' crossings with or without closure rails, arranged for cross track movements.

COMPOUNDS or SLIPS are a combination of a diamond crossover and points with closure rails connecting the crossover tracks within the intersection distance of the diamond, and may provide for one or two slip movements.

DOUBLE and DELTA CROSSOVERS consist of two crossovers intersecting to form a diamond between the centre lines of the outside tracks.

THREE THROWS are double or tandem turnouts arranged within a length of less than the sum of two separate turnout lead lengths.

RE-SLEEPERING is the operation of replacing existing sleepers with new or serviceable sleepers and fastenings to required sleeper spacing.

RE-BALLASTING consists of replacing or adding other ballast to the existing ballast.

LIFTING involves raising and packing the track to the required surface.

PACKING is the process of consolidating the ballast under the sleepers or timbers for the proper support of the track.

STRIPPING is the operation of removing from the track all ballast above the formation.

BOXING UP consists of filling the track with ballast.

TRIMMING is the operation of forming the ballast to the standard track profile.

TRACK PROFILE is the outline of the track in its completed condition on the formation.

CESS is the shoulder of the formation outside the track profile.

OUT OF FACE refers to the method of working forward continuously on the full width of track from one point to another.

SPOT refers to a given position at which work is carried out.

GULLETTING is the operation of removing ballast from the centre of the track.

STRENGTHENING TRACK refers to any or all of the operations of re-railing, re-sleeping, and/or re-ballasting.

CREEP is the longitudinal movement of rails in track caused by the action of traffic.

WAVE is the vertical sinuous movement of the track under the action of moving vehicles.

EXPANSION is the lengthening of rails under the influence of rising temperatures.

CONTRACTION is the shortening of rails under the influence of falling temperatures.

BUCKLING is a lateral displacement of track from its alignment caused by expansion of the rails.

ANCHORING is the means provided to restrain contraction and reduce creep.

.3.Permanent Way.

DEFINITIONS

The Permanent Way consists of the earthworks, drainage, structures, track and trackwork completed to clearance, grade and alignment in readiness for traffic.

To permit of traffic movements the permanent way comprises the track between stations and the trackwork at the stations, goods yards, etc.

Track consists of rails, sleepers, fastenings and ballast laid on the formation, in continuity, to line and grade.

Trackwork consists of arrangement of points and crossings with timbers and fastenings laid and connected to track.

For the control of traffic, signals and interlocking arrangements are provided.

In the preparation of the permanent way, cuttings, embankments, surface formation, bridges and tunnels are necessary according to location.

To protect the permanent way from damage by saturation and erosion, drainage has to be provided and maintained.

CROSS SECTION

The standard cross sections for single track permanent way are shown in Fig. 1, 2, and 3. In each case the cross sections are divided at the centre line to indicate a cross section through a shallow cutting on the right-hand side, and a cross section through a shallow bank on the left-hand side.

The size and location of side drains and cess drains are shown together with the slopes for earthwork and the profile of the track. Widths of formation shown are the minimum for the class of track indicated, although some light lines have been constructed to sub-standards.

EFFECTS OF TRAFFIC

The weight of the traffic is concentrated by the wheels on the rails at intervals according to wheel spacing. The wheel loads are distributed by the rail over the adjacent sleepers which in turn further distribute the load through the ballast to the formation.

In the course of transferring the wheel loads to the formation, the track is subjected to various stresses according to its construction and condition of maintenance.

The action of the track under load is exceedingly complex because of the variable conditions met with in practice. It is now known that the earlier conception of the sleepers being solidly supported and the rail flexing only between the sleepers was erroneous.

Actually the sleepers, the ballast, and the formation are compressed vertically and elastically. The track is depressed as a whole under and adjacent to the wheel loads, and rises between the wheels and on either side of the leading and trailing wheels.

This action may be more readily understood by considering the problem upside down, as in Fig. 4, in which the track is shown supported by the wheels for the purpose of the explanation.

The load, in Fig. 4, is the formation resting upon the track which is supported by the wheels, and it will be conceived that, under these conditions, the track would sag between the points of support.

In Fig. 5, the sinuous outline of the track under load is shown, and it will be clear that over a train length this outline would vary according to the wheel spacing, the loading and the condition of the permanent way.

Very extensive investigations have been made on overseas railways to determine the nature and extent of stresses in track, and the following conclusions may be briefly stated:-

- (1) Because the support afforded the rail is elastic, the rail is stressed to a greater extent than if it were rigidly supported.
- (2) The axle load has no direct relation to rail stress.
- (3) Locomotive design has an important bearing on the stresses produced in the rails.
- (4) Owing to the wide wheel spacing, a four-wheeled truck may cause stresses in the rail as great as those produced by a locomotive having the same axle load.

- (5) If the formation is weak more sleepers or more ballast should be used and not a heavier rail, but if the rail is not equal to the loading, closer spacing of the sleepers does little good.
- (6) To distribute the load on the formation, close spacing of narrower sleepers is better than wide spacing of wide sleepers, in other words, ten 8 inch wide sleepers are better than eight 10 inch wide sleepers.

The action of tension and compression takes place in the rails and in the supporting sleepers according to the direction of bending or flexing.

Reference to Fig.5, shows that the rail under the wheel flexes downwards with consequent compression of the rail head and tension in the rail flange, whereas between the wheels the flexure is upwards and the stresses in the head and flange are reversed.

TRACK WAVE

As traffic moves along the track the sinuous movement of the track likewise moves, giving a wave-like motion to the track structure. This wave movement is constantly reversing the stresses in the rail and it is due to the wave that dogspikes are started from their seating with the rail flange and rails creep generally in the direction of traffic.

Throat cutting of dogspikes, rail cutting of sleepers, and wear in the fishing angles at joints are increased according to the magnitude of the track wave.

The resistance offered by the track to wave depends chiefly upon sleeper spacing, the size and quality of the sleepers, the depth and class of ballast, solidity of formation, packing and the general condition of track maintenance.

As the rails transfer the load to the sleepers and the sleepers distribute the load through the ballast to the formation, flexing takes place in the sleepers according to the uniformity of support they receive from the ballast and the formation.

In Fig.6, an inverted section of the track structure is shown supported by the rails to illustrate the bending of the sleeper under the load of the formation.

The depression of the formation under the influence of traffic is shown in Fig. 7, from which it can be seen that no advantage is to be gained in respect to vertical support of the track by packing the centres of sleepers.

Sleepers should be packed from the ends to 15 inches inside the running edge of each rail as shown in Fig. 8.

The depressions of the formations, shown in Figs. 5, and 7, depend upon two factors, the depth of ballast and the condition of the formation. With deep ballast the load is spread over a greater area of the formation and the depression is less.

In Fig. 9, the areas of depression are shown by dotted lines indicating the conditions met with in practice; these lines illustrate the reason for the accumulation of water on the formation. See 6.05-6.06.

The depression at joints during the passage of wheels is particularly severe. For proper support the rail joint should combine the strength and stiffness with the flexibility of a continuous rail so that it would return to position after depression caused by the wheel loads on it, and thus carry the wave motion of the rail uniformly along the track.

With loose joints, when under load, the ends of the rails act as cantilevers each carrying half the load. Deflection of these two beams is nearly 10 times as great as that of the rail itself carrying the same load at the middle and considered as a beam.

The strength of the rail is not sufficient to distribute the load over the adjacent sleepers as it does at the middle of the rail; the joint sleepers therefore have to take practically the whole impact as well as being subjected to a rocking motion, and it is for this reason that joint sleepers are depressed to a greater extent than the intermediates.

Wear of the rails at the joints is caused by the wheels jumping over the deflected rail ends and is not due to the expansion space. To provide additional support at the joints the joint sleepers are more closely spaced than the intermediates.

Rails are laid with the joints either square or staggered; the staggered joints are found to set up oscillation at high speed unless the track is well maintained. On the other hand, the hammering effect which causes low joints is better distributed over the track with staggered joints than with square joints.

Opinions differ as to the merits of the joint systems, but there appears to be grounds for preference of square joints on straight track and staggered joints on curves.

Welded rails are now largely replacing the short rail formerly in use, but sections of short rail tracks will no doubt remain in service for some years to come, and the various standards which have been in use are shown in Figs. 10, 11 & 12 and Table 3.28. See 9.04.

CREEP

Creep is the longitudinal movement of rails in track caused by the action of moving vehicles.

The principal cause is the wave motion of the track due to its alternate depression and release under intermittent wheel loads. Arching of the track between wheels, accompanied by the continuous forward movement of the train, converts the movement into an undulating wave. The momentum of the train exerts a forward pressure upon the upward incline of each wave and tends to carry the rail forward in the direction of traffic.

Creep however is not consistent; in some cases on single track the rail creeps up the grade for some distance from the foot of the grade, while the creep at the summit of the grade is down hill. These conditions are probably due to the higher speed of trains approaching the ascent of the grades and to the application of the brakes on descent.

Occasionally one rail on straight track will creep, and sometimes both rails will creep in opposite directions. On curves the outer rail usually creeps more than the inner rail due to the greater pressure exerted on this rail, but if the cant is excessive thereby throwing too much weight on the inner rail, the creep may be more pronounced on this rail.

Allowing for the unusual cases, it may be said in general that creep is most likely to take place under the following conditions : -

1. On curves.
2. On grades.
3. On embankments.
4. At stopping places when brakes are applied.

The general tendency for creep is in the direction of traffic on double tracks and in the direction of the heavier traffic on single tracks.

Factors restraining creep are : -

1. Friction of the rail base on the sleepers.
2. Friction of the dogspikes against the rails.

Both of these factors are reduced with time due to wear and smoothing of the surfaces in contact.

Pins through the rail flange and dogspikes in slotted fishplates concentrate the creep load at joint sleepers and aggravate the joint conditions by pushing the joint sleepers off the packing, slewing or splitting the sleepers and bending the dogspikes sufficiently to slip clear of the slots in the fishplates.

It is now generally agreed that the method of concentrating the creep at joint sleepers is unsound because of the extra duty imposed on the joint which in itself constitutes the weakest part of the track.

With the introduction of angle fishplates pin anchoring was replaced by spike anchoring in the slots at the base of the fishplates. With the latest standard bar type fishplates anchor dog slots are omitted.

Creep is now controlled by the application of rail anchors to the rail flange with side bearing against the sleepers, the number of anchors required depending on the conditions outlined above. See 9.18 & 10.11.

STRAIGHT TRACK

Running conditions on straight track depend upon gauge, alignment and running surface. Recent research points to the necessity of a stiff track most carefully lined and cross levelled.

The importance of alignment is greater with trains running at high speed than with slowly moving trains as the lateral blows from the wheel flanges increase in severity at higher speeds.

Both grade and cross-level are involved in good running surface; changes in cross-level obviously affect the grade of one or other of the track rails, and the combined effect produces lurching and oscillation of vehicles.

RUNOUTS

The difference in surface between sections of track during lifting operations necessitates the introduction of temporary ramps described as Runouts.

Runouts should be graded to permit of fast trains ascending the ramp. The cross-level of the track must be maintained and the grade of the ramp should be sufficiently flat to avoid shock to the train. See 11.03.

CURVED TRACK

Curves enable the direction of track to be gradually changed in accordance with requirements.

In hilly country the track may frequently change direction to pass round the sides of hills and the ends of valleys, thus obviating the necessity for bridges, tunnels, deep cuttings and high embankments. By the use of curves the track is lengthened and suitable grades are made possible on steep slopes.

In Victoria the measurement of curvature is the radius measured to the centre line of the track and usually expressed in chains. (See 3.25). Curves are right-hand or left-hand according to direction when viewed from Melbourne.

TYPES OF CURVES

Several types of curves are in use according to purpose and location.

The simple curve is a curve of regular radius connecting with two lengths of straight, as in Fig. 13, and is used to provide a change of direction.

If the curve is of large radius, the change of direction on entering the curve is very gradual, but when the radius is small the rate of change of direction increases rapidly with the reduction of radius. See Fig. 14.

Under the influence of traffic the track at the tangent point of a simple curve with the straight track is gradually forced outwards, thus increasing the radius of the curve towards the ends and continuing the curvature along the straight track, as shown in Fig. 15.

COMPOUND CURVES

It is not always possible to connect straight tracks by simple curves, and curves of different radii may be used in conjunction, as in Fig. 16. Curves of this form are described as Compound Curves.

At the tangent points of compound curves if the difference in radius is pronounced, similar conditions obtain as at the tangent point of a simple curve with a straight, and the track tends to kink outward altering the curvature at these points.

REVERSE CURVES

Reverse curves occur when right and left-hand curves adjoin, as in Fig. 17. This arrangement is very unsatisfactory owing to the sudden change in direction at the point of reversal, and it is usual to connect reverse curves by a straight of sufficient length to enable the vehicles to complete one change of direction before commencing the next.

The length of straight required depends upon the speeds of traffic and the runouts required to adjust the cant.

TRANSITION CURVES

A transition curve is a short curve of varying radius laid to connect straight and curved track or curves of different radii. These curves were formerly provided at both ends of simple curves of 40 chains radius and under, but are now being provided for all curves where conditions permit.

Transition curves serve two purposes : -

- (1) They provide a means of gradually changing the direction of traffic.
- (2) They vary the radius in harmony with the increase of cant.

CUBIC PARABOLA

The form of transition curve in use in Victoria is a Cubic Parabola. Its length was formerly fixed at 150 feet for broad gauge and 100 feet for narrow gauge, but recent practice provides for varying the length of the transition curve.

Transition curves of the same length have more or less curvature according to the radius of the central curve. This will be seen from Fig. 18, in which the length of the transition shown dotted is the same as that in full line, but the radii of the central curves are different.

The radius at any point in a transition curve is directly related to the radius of the central curve with which it joins, and when the length is divided into six equal spaces the approximate radius at each position and the relative amount of cant will be as follows : -

Position	Approx. Radius	Relative Cant
TTP with straight	Infinite	None
First station	6 times Rad. Cen. Curve	1/6 Full Cant
Second "	3 " " " "	1/3 " "
Third "	Twice " " "	1/2 " "
Fourth "	1 1/2 times " " "	2/3 " "
	1.1/5 " " " "	5/6 " "
CTP with central curve	Same " " "	Full Cant

The alignment of the straight track is displaced parallel to the tangent of the central curve by the 'shift distance', and the amount of shift depends upon the radius of the central curve and the length of the transition.

The shift distance is obtained by substituting the known values in the formula : -

$$S = \frac{L^2}{24R}$$

in which S = shift in feet, L = length of transition in feet, R = radius of central curve in feet.

Transition curves are set out by a surveyor using the transit or theodolite and by measuring deflection angles between survey stations.

The following explanation and example have been included to give trackmen a clearer understanding of the general proportion of transition curves.

Offsets from the tangent increase in proportion to the cube of the distance from the transition tangent point or T.T.P. At the common tangent point or C.T.P., the offset is four times the shift distance or $\frac{L^2}{6R}$.

Intermediate offsets are readily found by multiplying this offset by the constants given hereunder.

Constants for a six Station transition							
Station No.	0	1	2	3	4	5	6
Constant	0	.0046	.037	.125	.296	.579	1

The offsets at each 25 feet for a 150 foot transition connecting straight track with a 10 chain radius central curve as shown in Fig. 19, are as follows : -

$$\text{Offset at C.T.P.} = \frac{L^2}{6R} = \frac{150 \times 150}{6 \times 10 \times 66} = 5.68'$$

Station 0 = Nil

$$1 = .0046 \times 5.68 = .02' = \frac{1}{4}''$$

$$2 = .037 \times 5.68 = .21' = 2\frac{1}{2}''$$

$$3 = .125 \times 5.68 = .71' = 8\frac{1}{2}''$$

$$4 = .296 \times 5.68 = 1.68' = 1'8\frac{1}{4}''$$

$$5 = .579 \times 5.68 = 3.29' = 3'3\frac{1}{2}''$$

$$6 = 1.000 \times 5.68 = 5.68' = 5'8\frac{1}{4}''$$

Transition curves between compound and reverse curves are shown in Figs. 20 and 21.

CURVE PEGS

To enable the various types of curves to be maintained to correct radius and uniform alignment, track centre line pegs are provided at intervals according to radius and type of curve.

Certain other pegs indicating the main base lines from which the track centre pegs are located will be found in positions according to their purpose; centre line pegs are painted white and base line pegs, blue. See 19.04-19.05.

Centre line pegs placed by the surveyor are 3" x 3" square pegs driven to within $\frac{1}{2}$ " of the top of the sleeper, and the centre line of the track is indicated by a nail driven in the peg as in Fig. 22A.

Curves of regular radius less than 40 chains are pegged at intervals of 25 feet and over 40 chains at intervals of 50 feet.

The straight track adjoining the curve may have centre line pegs extending for some distance from the TP, and the prolongations of the tangents are frequently marked by pegs at the boundary fence as in Fig. 23.

Transition curves are pegged at equal intervals according to the length of the transition. In the case of 150 feet transitions the centre pegs are about 25 feet apart. The pegs at the TP's of transition curves are marked by two nails on each side of the centre nails, the alignment of the nails indicating the beginning and ending of the transition, as follows : -

TTP of straight and transition, nails "across" the track.

CTP of transition and central curve nails "along" the track. See Figs. 22B and 22C.

The cant in inches and fractions of an inch is indicated by figures stamped on the top of the centre line pegs as shown in Fig. 22D. This indicates that the outer rail should be $1\frac{1}{2}$ inches above the inner rail at the position marked by this peg. On the web of the outer rail opposite the centre line peg the amount of cant is marked in white figures as a further guide should the figures on the peg become illegible.

When tracks are lifted and the centre line pegs would be obscured by ballast, it is necessary to install indicator pegs driven 6 inches on the up side of the original centre peg which must be left undisturbed.

The importance of carefully preserving all pegs provided for the correct alignment and surface of track should be clearly apparent, and the instructions issued by the Department in this connection should be carefully studied.

CANT Cant is the vertical distance of the outer rail above the inner rail on curved tracks.

A train on entering a curve and passing over it has a tendency to continue moving in a straight line or to follow the tangent to the curve at any point. See Fig. 24.

This tendency is opposed by the re-action of the outer rail and results in compression of the springs over the outer wheels of the train. The compression of the springs increases the load on the outer rail, and the tendency to continue in a straight line causes the wheel flanges to grind along the running edge of the outer rail.

If the outer rail of a curve be elevated above the inner rail the effect of the load distribution on the two rails will depend upon the speed of the train.

When a train is stopped on such a curve more weight will rest on the lower rail, but on starting, as the speed increases the weight on the outer rail increases, and if all trains could be run over the curve at a definite speed it would be possible to so elevate the outer rail to exactly balance the loading on both rails.

As both fast and slow trains run on the same tracks, the full cant desirable for the high speed trains would be excessive for the slow trains, and therefore an average cant is applied.

The tendency to run off the curve is greater with curves of small radius than with curves of large radius, and also for the same speed considerably more cant is required on curves of small radius than on curves of large radius. Curves of small radius are rarely used in main tracks, but where they exist suitable speed restrictions are applied, and the cant in these circumstances is reduced accordingly.

In special circumstances when the average speed over the curve is higher than the usual average speeds on a curve of this radius, an increase in cant may be warranted. Conversely where the average speed over the curve is low, a reduction in cant may be desirable.

Running conditions approach the ideal when the mean speed of trains corresponds with the cant speed for equilibrium cant, a slight deficiency of cant being preferable to an excess of cant.

In all cases where the cant is varied from standard, the curves are re-pegged and the required cant is indicated in the usual way. See 3.10.

EQUILIBRIUM CANT

Equilibrium cant or the cant required to throw an equal wheel load on the inner and outer rails of a given curve at a given speed of 5'3" gauge is found by the formula : -

$$C = \frac{.064 S^2}{R}$$

where C = cant in inches, S = speed in miles per hour, and R = radius of curve in chains.

If a curve of 40 chains radius be selected and the equilibrium cant be calculated for various speeds, the results would be as follows : -

Speed MPH	10	20	30	40	50	60	70
Equilibrium cant(inches)	$\frac{3}{16}$	$\frac{5}{8}$	$1\frac{7}{16}$	$2\frac{9}{16}$	4"	$5\frac{3}{4}$	$7\frac{13}{16}$

It is found in practice that satisfactory running conditions can be obtained for a range of speeds such that an 'excess' or 'deficiency' of cant does not vary more than 3 inches from the calculated equilibrium cant.

The regulation cant for a 40 chain curve is 3 inches, and the maximum allowable speed 60 MPH. Thus the variation of cant for all speeds is within the allowable excess or deficiency of 3 inches.

To determine the cant to meet special circumstances an average is taken of the speeds of all trains passing over the curve, and this is combined with the average speed of the fastest trains. This gives a mean speed for which a suitable cant may be specified.

Trackmen are not concerned with the calculations for cant, and the example is included only as information.

Permanent changes in the mean speed of trains may require an alteration of cant and the evidence that this is desirable should be apparent to the man on the length.

Excessive cant generally results in heavy surface wear and flow of metal on the inner rail, and this may be accompanied by reversal of rail inclination due to rail cutting of the sleepers, and general wear and looseness of the fastenings of the inner rail.

Deficient cant is indicated by heavy wear on the running edge of the outer rail, throat cutting of the dogspikes on the outside flange of the outer rail, and general difficulty in maintenance of true alignment.

When these conditions are apparent at portions of a curve steps should be taken to check and correct the cant and alignment. If the condition is constant throughout the curve the matter should be reported to enable a complete check to be made on train speeds with a view to revision of cant.

STANDARD CANT

The standard cant for main line of 5'3" gauge is as follows : -

Radius of Curves in Chains		Cant in Inches
From 6 to less than 50	..	3
" 50 " " 60	..	2½
" 60 " " 80	..	2
" 80 " " 100	..	1½
Over 100	..	1

The cant on every main track of 2'6" gauge for any curve must be varied in accordance with the maximum permissible speed for the particular line, or part of the line, as shown in the following table : -

Speed limits in miles per hour.							
Cant in Inches	Up to 10		Over 10 to 15		Over 15 to 20		Cant in Inches
	Rad. in chains		Rad. in chains		Rad. in chains		
	From	To	From	To	From	To	
2½	-	-	-	-	5	6	2½
2	-	-	3	4	over 6	8	2
1½	2	3	over 4	6	" 8	12	1½
1	over 3	5	" 6	12	" 12	21	1
½	" 5	-	" 12	-	" 21	-	½

Uniformity of cant is far more important than the exact amount of cant.

GRADE RAIL

The inner rail of curves is maintained to grade and the cant obtained by elevating the outer rail. See 11.01.

CANT RUNOUTS

The elevation of the outer rail is uniformly decreased by a runout according to the alignment of the track, the cant runout being made in the transition curve when provided, or in the straight commencing at the TP of the central curve. See Figs. 25 and 26.

The maximum rate at which a cant runout may be made is one-half inch in twentyfive feet, which is equal to a grade of 1 in 600.

With compound curves the difference in the cant is run out in the curve of larger radii commencing at the CTP as shown in Fig. 27.

In the case of reverse or following curves in which the length of straight between them is too short to permit of the cant being run out at the rate of 1 in 600, the rails midway between the TP of the two curves must be level, and a uniform increase in cant be provided at the rate of 1 in 600 from this point in both directions until the full cant for each curve is obtained. See Fig. 28.

CURVE WEAR

The rate of wear on rails, sleepers and fastenings is greater on curves than on straight track owing to the tendency of the trains to run in a straight line and the resistance offered by the track in directing the course of the train to follow the curve.

Direction is imparted to the train by contact of the wheel flanges with the outer rail of the curve, and in consequence wear takes place between the wheel flanges and the running edge of the outer rail.

SPREADING OF GAUGE

The outward pressure on the outer rail causes wear and distortion of the fastenings and spreading of the gauge.

If the wheels rolled freely on the axles and the axles were not restrained in position and direction by the frames of the vehicles, each wheel could adjust itself to the length and direction of the rail on which it rolled, but these conditions do not obtain.

Wheels are fixed to the axles and axles are restrained in bearings within frames to proper alignment for running on straight track. Under these conditions of restraint the path followed by the wheels and the tendency to spread the gauge depend upon the number and arrangement of wheels in the various units of rolling stock.

POSITION OF WHEELS

The simplest wheel arrangement is a two axle vehicle and experience has shown that when a vehicle of this type rolls freely on a curve the wheels take up a definite position with the trailing axle radial relative to the curve, as shown in Fig. 24.

As the vehicle rolls forward the wheels, being of the same diameter and fixed to the axles, tend to proceed in a straight line and to cover equal distances in the same time. The length of the inner rail being shorter than the outer rail and the direction of motion being altered by the curve cause the wheels to slip laterally in adjusting their position relative to the curve.

Lateral slipping results from the leading outer wheel riding up on the fillet with the wheel tread off the running surface of the rail until a point is reached when the weight on the wheel causes it to drop back to normal running position.

The path of motion of the leading wheels consists of a series of forward movements tangent to the curve and of minor lateral movements, as shown in Fig. 29.

Coning of wheel treads was originally done with the object of the wheels running on the larger diameter on the outer rail and the smaller diameter on the inner rail when traversing curves. This condition could, however, only apply to a single axle and not to two or more axles in a rigid frame.

It was also thought at one time that on straight track the coned wheel would tend to centre the wheels within the gauge, but experience has shown that even slight unevenness of track surface causes the coned wheels to hunt on straight track. The reason for retaining the coned wheel is largely to offset the wear of wheel treads which tends to reverse the concavity of the tread.

Truck wheels running on light line rails with $2\frac{1}{4}$ " width of rail head are naturally worn to a hollow close to the flange and the initial coning permits of longer service between tyre returnings.

RAIL HEAD FLOW

Lateral movement of the wheel treads causes the running surface of the inner rail to flow inwards towards the centre of the curve forming a fin of metal on the outside of the rail head as shown in Fig. 30. See 9.15.

On curves, when the rails are laid on the adzed surface of the sleepers, the lateral sliding movement of the wheels tends to overturn the inner rail outwards from the track and the load is concentrated towards the outer edge of the rail flanges with consequent crushing and abrasion of the timber fibre and the tendency to reverse the rail inclination, as shown in Fig. 31.

EFFECT OF WHEEL BASE

As the axles are arranged parallel to each other in the underframes of the vehicles, they cannot run radially to the curve, and the extent to which they can run askew depends upon the distance between the axles, or what is known as the wheel base.

In bogie frames the two axles are closely spaced, and if allowed to roll freely both axles take up a position almost radial to the curve, but when the bogie forms part of a locomotive wheel mounting its direction is controlled by the manner of attachment to the main frame, and conditions arise when the leading outside wheel has difficulty in adjusting its lateral position.

Under these conditions the short wheel base permits the bogie to run askew as in Fig. 32, with the leading edge of the leading outer wheel flanges at an angle to the outer rail. Running continuously in this position the lower edge of the flange is in contact a little ahead of the vertical centre of the wheel and considerable wear takes place on both the flange and the running edge of the outer rail.

ANGLE OF APPROACH

If the gauge is wide due to wear or other reasons, and the wheel flanges are thin due to wear, the angle of approach of the flange to the outer rail will be greater than if the gauge is neat and the flanges are full section.

It is an axiom in mechanical matters that wear be-gets wear, and it will be clear that undue widening of the gauge or reduction of the width of wheel flanges relative to the gauge will increase the rate of wear on curves owing to the extra skew and wider angle at which the wheel engages the running edge.

The average angle of side wear on the outer rail of all curves appears to be 24° and the average angle of wear on wheels to be 21° , which is a further indication that the wheels do not run in full flange contact with the rail on the vertical centre line of the wheel, but some little distance in advance, as shown in Fig. 33.

With three axles in a frame of a vehicle the leading wheel crowds the outer rail, but the disposition of the other wheels differs from that of a two axle vehicle, the tendency being for the vehicle to run radial to the curve at a position between the intermediate and trailing axles, as shown in Fig. 34.

In locomotives having leading and trailing pony or bogie trucks restrained by the manner of attachment for running on straight track, there are various forces which come into effect on traversing a curve, and the disposition of the wheels is affected by the manner of suspension of the auxiliary frames, the amount of side play in the axle boxes, thickness of flanges and distance between wheel mountings.

WIDENING OF GAUGE

The necessity for widening gauge on curves of small radius arises from the use of several sets of wheels and axles in the fixed frames of locomotives.

To illustrate this point it will be clear that if a bar of iron which will just freely pass through a length of straight tube be inserted in a similar but curved tube, some bending will take place according to the amount of curvature in the tube, and a condition arises when to pass the bar through a curved tube either the bar must bend or tube somewhat straighten. If a larger tube of the same curvature be used the bar may pass through this tube with freedom.

In the same way long wheel base multiple axle vehicles may pass round curves if sufficient widening is provided; however, excessive widening cannot be permitted owing to the angle of skew which would occur with bogie stock. See 3.16.

CHECK RAILS ON CURVES

The purpose of check rails on curves is to check or control the running position of wheels, and they are therefore arranged at such a position as to continuously make contact with the back of some of the wheels according to the types of vehicles in running.

Usually the check rails are placed adjacent to the inner rail of the curve at a distance of $5'1\frac{1}{4}"$ from the running edge of the outer rail. In this position the backs of locomotive wheels are in contact simultaneously with the outer rail and the check rail as shown in Fig. 35, and side wear is distributed between these two rails.

Under these conditions, if the gauge is widened, the flangeway is widened by the same amount to preserve the distance of $5'1\frac{1}{4}"$ from check rail to outer rail.

If the check rail be placed adjacent to the outer rail, the position of the trailing wheels in bogie stock is controlled and the angle of approach of the leading wheel is reduced, as shown in Fig. 36.

With the introduction of track lubrication the necessity for installing wearing check rails has been much reduced, and they are gradually being abolished during re-laying operations.

DOUBLE CHECK RAILS

On curves of very small radius locomotives with flangeless intermediate driving wheels are used, and double check rails are provided to control the rolling positions of leading and trailing flanged wheels and to provide a running surface for the flangeless wheels as shown in Fig. 37.

CHECK RAIL FLANGEWAYS

The width of flangeway required depends upon the radius of the curve and the wheel arrangement of the longest multiple axle locomotive allowed to run over the curve.

As the alignment of the wheel flanges forms a chord to the curve with the leading and trailing wheels in contact with the outer rail and the intermediate wheels some distance clear of the outer rail, it follows that a check rail placed adjacent to the outer rail must be sufficiently distant to clear the backs of the intermediate wheels as shown at 'A' in Fig. 38.

Conversely the alignment of wheel flanges relative to the inner rail will be such that the intermediates will be in contact with the running edge of the inner rail, and the backs of the leading and trailing wheels will be some distance clear of the inner rail, such that a check rail placed adjacent to the inner rail will just contact the wheel backs of the leading and trailing wheels as shown at 'B' in Fig. 38.

RUNNING CLEARANCE

The wheel mountings of Victorian locomotives provide for lateral movement within neat gauge of $\frac{3}{4}$ " with unworn tyres of old standard, and $11/16$ " with the new A.N.Z.R. standards, measured at $5/8$ " below the running surface of the rails.

Intermediate wheel flanges are thinner to give more running clearances on curves, and the arrangement of the wheels in the fixed frames is as shown in Fig. 39, in which an 8 coupled locomotive of the H,C,K,N, or X classes is shown on a right-hand curve in full line and super-imposed on a left-hand curve in dotted line, illustrating the necessity for reducing the thickness of intermediate flanges on both sides of the locomotives.

When the main driving wheels are restrained in direction by the running and check rails, considerable side pressure will be exerted on the rails if the flangeways are insufficient to provide a running clearance. If the check rails are braced and insufficient running clearance is provided, there will be a danger of mounting or the running rail may be ploughed out and over-turned.

From what has been said it will be seen that widening of gauge, width of flangeway and running clearance depend upon the radius of curvature and the wheel arrangements of vehicles and that ideal conditions cannot exist equally for all cases.

For locomotive reasons a wider flangeway is required for check rails on the outer rail than for check rails on the inner rail; the actual widths for safe and effective use are determined from considerations of the classes of rolling stock running on the particular curve, and detailed plans of the check rail fastenings and width of flangeways are provided for the information of trackmen.

GUARD RAILS

Guard rails on curves are provided for safety and do not contact any of the wheels in service, but in the event of any wheel mounting its running rail the back of the mating wheel comes into contact with the guard rail and complete derailment is prevented.

Curves of 20 chains radius or less which pass over bridges are provided with a guard rail along the inner rail having a minimum flangeway of $2\frac{1}{2}$ ", but in heavy rails wider flangeways are in use and a standard guard rail is fixed at the ends of the main guard rail to draw the mounting wheel back to the gauge .

On single track a standard guard rail is fixed at each end of the main guard rail, but on double tracks one guard rail is fixed at the leaving end of the main guard rail. See 14.098.

OVERLAP OF GUARD RAILS

At the T.P's of reverse curves the guard rails overlap for some distance and at bridges they extend beyond the bridge for a length of not less than 20 feet.

CONDUCTIVITY RAILS

In the electrified area where manganese rail is laid as the outer rail on some curves, it is necessary for signal current to provide a path of conductivity other than the manganese rail owing to the higher electrical resistance of manganese steel, and a carbon steel rail is sometimes laid within as a guard rail, or as a separate rail on the out ends of the sleepers with suitable bonding connections.

The arrangement of the guard rails and conductivity rails in use on the Flinders Street Viaduct is shown in Fig. 40.

CURVE RESISTANCE

The resistance offered by a curve to the passage of a train depends upon many factors over which the trackman has no control - the radius of the curves, the gauge of the railway, the adopted cant of the outer rail, the speed and length of trains, the size and arrangement of wheels, the form of the wheel tyres, conditions of wear, etc.

Factors which are directly in the hands of the trackman, and which if neglected add materially to the resistance of any curve, are : -

1. Regularity of curvature.
2. Uniformity of cant.
3. Maintenance of joints.

Excessive wear is the result of high resistance; this resistance involves an expenditure of motive power which could be better employed in the haulage of pay load, and on the other hand, wear resulting from resistance is the cause of costly replacement in rails and fastenings.

TRACK LUBRICATION

The application of a lubricant between the running face of wheel flanges and the running edges of rails greatly reduces the wear of the flange and the rail.

Track lubrication may be effected by lubricating devices attached to rolling stock or fixed to the rail at suitable locations. When the traffic is sufficiently dense to warrant lubrication the most economical type of lubricator is the fixed type attached to the rail.

The lubricant most suitable to the purpose is a specially prepared grease containing graphite (a material of the nature of black lead).

Track lubrication necessarily involves an expense in the purchase and maintenance of the lubricators and the supply of lubricant, and to justify their installation it follows that the savings by their use must exceed this cost.

Gouging of the rail sides at isolated positions on short curves does not generally warrant the installation of a track lubricator, but obviously points to the necessity for properly curving the rails in the first place and in maintaining the gauge, curvature, cant, and joint conditions which in turn may depend upon the maintenance of fastenings, sleepers, ballast, formation, and last but not least, proper drainage.

For particulars of the track lubricators in present use, see 16.06.

GRADE

The grade is the rate of slope of the surface of the track in the direction of its length.

Thus a grade of 1 in 50 indicates a rise or fall of 1 foot in 50 feet, and grades are shown in this way on departmental plans.

To express a grade in per cent divide 100 by the rate of the grade.

For example : - 1 in 50 grade = $\frac{100}{50}$ = 2 per cent grade.

To express a grade at a rate per chain divide 66 by the rate of the grade.

For example : - 1 in 50 grade = $\frac{66}{50}$ = 1.32 rate per chain.

According to the direction of traffic, grades are described as rising or falling. The highest point on a grade is called the summit or top of the grade and the lowest point is the foot or bottom of the grade.

In Fig. 41, is shown a typical section of the grades on a portion of the Eastern Line.

RULING GRADE

The ruling grade is the steepest grade on a line up which a given engine can pull its full load.

MOMENTUM GRADE

A short steep grade which requires the momentum of the moving train to assist the tractive effort of the engine for its ascent is described as a Momentum Grade.

GRAVITATION GRADE

In marshalling yards the grades are arranged to permit of the vehicles rolling under the influence of gravity when the brakes are released. This type of grade is known as a Gravitation Grade and may vary from 1 in 100 to 1 in 300; the former is necessary when the movement is through trackwork layouts.

LEVELS

Levels are vertical positions in relation to low water Hobsons Bay, Melbourne, and are referred to on departmental plans and sections as the Reduced Levels or R. L.

Levels on the New South Wales Railways are referred to mean surface level at Fort Denison, Sydney and differ from the Victorian Railway levels by 2.89 feet, being lower by this amount.

The reduced levels at two points on a constant grade differ by an amount equal to : -

Distance in chains between points x rate per chain of grade.

For example : - the difference in levels between two points 6 chains apart for a rate of .33 per chain equals : -

$$6 \quad x \quad .33 \quad = \quad 1.98 \text{ feet}$$

VERTICAL CURVES

The natural contour of the country necessitates frequent changes in the grade, and at the points of grade change angles are formed according to the inclination of the grades. At these change of grades points the vehicles of a train tend to run together in the sags and to pull apart at the summits.

To ease the train from one grade to another vertical curves are introduced as shown in Fig. 42. Vertical curves gradually change the vertical direction of trains in the same way as transition curves gradually change the horizontal direction of a train.

The form of vertical curve in use in Victoria is a parabolic curve, the length of which varies according to the angle formed by the intersecting grades and the rate of change of grade permissible for the speed of traffic.

These curves are set out with temporary grade stakes for the information of trackmen and care must be taken not to disturb the level of the stakes prior to surfacing the track.

At the approach to bridges the subsidence of embankments may necessitate the introduction of short grades and vertical curves as shown in Fig. 43.

Such curves are not to be confused with depressions in track as any lifting above the grade would defeat the object of the vertical curves provided and re-introduce an abrupt change of grade.

The following example is included to give trackmen a clearer understanding of the general proportions of vertical curves.

$$\text{Length of vertical curve in chains} = \frac{\text{Deflection of grades per chain}}{\text{Allowable rate of change of grade per chain.}}$$

Offsets or ordinates from the grade line increase in proportion to the square of the distance from the commencement of the vertical curve and are readily found by multiplying the allowable rate of change per chain by the constants given hereunder : -

Constants for a Six Station Vertical Curve							
Station No	0	1	2	3	4	5	6
Constants	0	$\frac{1}{2}$	2	$4\frac{1}{2}$	8	$12\frac{1}{2}$	18

To determine the rail level at each station of the vertical curve the offsets must be added to grade level in sags and be deducted from grade level on summits.

Referring to Fig. 44, the length, offsets, grade levels and rail levels for a vertical curve connecting rising grades of 1 in 200 with 1 in 40 at a rate of change of grade equal to .22 feet per chain are determined as follows : -

$$\begin{aligned} \text{Grade constants for } 1 \text{ in } 40 &= \frac{66}{40} = 1.65 + \\ \text{" " " } 1 \text{ in } 200 &= \frac{66}{200} = .33 + \\ \text{Deflection of grades} &= \text{difference} = \underline{1.32} \\ \text{Length of vertical curve} &= \frac{1.32}{.22} = 6 \text{ chains} \end{aligned}$$

Grade level	+ Offsets from grade level	= Rail level
	Station No	
100	0 = Nil	100
100 + .33 = 100.33	1 = $\frac{1}{2}$ x .22 = .11	100.44
100 + .66 = 100.66	2 = 2 x .22 = .44	101.10
100 + .99 = 100.99	3 = $4\frac{1}{2}$ x .22 = .99	101.98
100 + 1.32 = 101.32	4 = 8 x .22 = 1.76	103.08
100 + 1.65 = 101.65	5 = $12\frac{1}{2}$ x .22 = 2.75	104.40
100 + 1.98 = 101.98	6 = 18 x .22 = 3.96	105.94

Deflection of grades is the algebraic difference of the grades. Rising grades are regarded as positive (+). Falling grades as negative (-). See Fig. 45.

CURVE COMPENSATION

Curves and grades occur simultaneously in hilly country, and their combined effect is to increase the resistance to the passage of trains.

When curves occur in conjunction with a ruling grade it is necessary to reduce the grade so that the combined resistance of the grade and the curve do not exceed the resistance of the ruling grade.

Reduction of grade to balance curve resistance is defined as Curve Compensation. The amount of compensation usually allowed is equivalent to a grade of $\frac{1}{2}$ in $\frac{R}{2}$ where R is the radius of the curve in feet. The compensation required on a 1 in 50 grade for a curve of 10 chains radius is : -

$$\frac{R}{2} = \frac{10 \times 66}{2} = \frac{660}{2} = \frac{330}{1} \quad \text{or} \quad 1 \quad \text{in} \quad 330$$

$$\text{Rate per cent 1 in 50 grade} = \frac{100}{50} = \frac{10}{5} = 2.00\%$$

$$\text{" " " 1 in 330 " } = \frac{100}{330} = \frac{10}{33} = 0.30\%$$

$$\text{" " " compensation grade} = \text{difference} = \underline{1.70\%}$$

$$\text{Compensated grade} = \frac{100}{1.7} = 59 \quad \text{or} \quad 1 \quad \text{in} \quad 59 \quad \text{approx.}$$

Thus on a ruling grade of 1 in 50 the equivalent compensation grade is 1 in 59 for a 10 chain radius curve or a rise in one chain of 1.12 feet instead of 1.32 feet on the straight.

The following grades all offer about the same resistance to traction : -

1 in 50 on	straight	track
1 in 52 on	40 chain radius	curve
1 in 54	" 20	" "
1 in 59	" 10	" "

CLEARANCE

The clearance between the loading gauge and the structure gauge is shown in Fig. 46, for broad gauge tracks, and in Fig. 47, for narrow gauge tracks on the straight.

In curves allowances must be made for : -

1. Overhang of vehicles both inside and outside due to the curvature.
2. Overhang of vehicles on the inside due to cant.
3. Oscillation of the vehicles due to running conditions.
4. Wear of rails and wheel flanges, and side clearance in the axle boxes and mountings.

As the radius of curves, the cant, length and outline of vehicles all vary, it is necessary to provide suitable clearances according to the conditions. The clearances required are determined by Head Office, but the principles involved will be appreciated from inspection of Figs. 48, 49, 50, and 51.

In all cases when making clearance measurements with the standard platform clearance gauge, allowance must be made for side wear of the rail and the centre of the track must be accurately determined.

If the tracks are curved the cant should be checked, and the gauge be set up for the correct cant as set out in the Way & Works Instruction Book.

Whether the tracks are curved or straight, instructions provide for one long sleeper to be placed near each end and one near the centre of platforms in contact with the platform structure to establish the correct clearance at these positions and thus assist in the maintenance of the required clearance.

The minimum clearance between adjacent tracks, measured at the running edges of the rails, is 6'5" for broad gauge (5'3") and 8'6" for narrow gauge (2'6").

CURVATURE

If for any reason the radius of curvature is in doubt it may be approximately determined as follows : -
With a 66 foot tape as a chord on the running edge of the outer rail, measure the middle offsets in inches in several positions, as shown in Fig. 52. Take the average of the measurements so made and divide 99 by the average middle offset.

For example, if the measurements taken at four places were $4\frac{3}{4}$ ", $4\frac{1}{2}$ ", $4\frac{1}{4}$ " and $4\frac{1}{2}$ ", their sum equals 18" and the mean average = $\frac{18}{4} = 4\frac{1}{2}$ " = $\frac{9}{2}$ "

The approximate radius in chains is : -

$$\frac{99}{1} \div \frac{9}{2} = \frac{99}{1} \times \frac{2}{9} = \frac{198}{9} = 22 \text{ chains}$$

If a 33 foot tape is used the mean average offset must be multiplied by 4 and the result be divided into 99.

More accurate results will be obtained if a thin string line is available to stretch between points marked with the tape.

A 20 foot string is very suitable for checking curves of small radii, middle offsets to be measured in sixteenths of an inch and divided into 9600, thus : -

$$\text{Approximate radius in feet} = \frac{9600}{\text{sixteenths}}$$

For example, the middle offset on a 20 foot chord equals $\frac{20''}{16}$

$$\text{Radius} = \frac{9600}{20} = 480 \text{ feet}$$

CURVING RAILS

For the purpose of curving short rail up to 45 feet long, offsets should be measured as shown in Fig. 53.

$$\text{Middle offset} = \frac{3}{2} \times \frac{\text{chord}^2}{\text{radius}}$$

$$\text{Quarter offsets} = \frac{3}{4} \text{ middle offset}$$

The chord and radius to be stated in feet and the offset will be in inches.

For example : - the middle and quarter offsets are required for curving a 45 foot rail to 600 feet radius : -

$$\text{Middle offset} = \frac{3 \times 45 \times 45}{2 \times 600} = \frac{81}{16} = 5.1/16 \text{ inches}$$

$$\text{Quarter offset} = \frac{3}{4} \times \frac{81}{16} = \frac{243}{64} = 3.13/16 \text{ inches}$$

3.27

To curve the ends of a long rail, offsets should be measured as shown in Fig. 54.

$$\text{End offset} = \frac{6L^2}{R}$$

$$\text{Offsets at } \frac{1}{2} \text{ length} = \frac{1}{4} \text{ end offset}$$

The length and radius to be stated in feet and the offset will be in inches.

For example : - the end offset and offset at $\frac{1}{2}$ length required to curve 10 feet at the end of a long welded rail to 1200 feet radius are : -

$$\text{End offset} = \frac{6 \times 10 \times 10}{1200} = \frac{1}{2} \text{ inch}$$

$$\text{Offset at } \frac{1}{2} \text{ length} = \frac{1}{4} \times \frac{1}{2} = \frac{1}{8} \text{ inch}$$

STANDARDS FOR SHORT RAIL TRACKS

			LENGTH OF RAIL								
			22'6"	22'6"	23'0"	28'6"	31'6"	31'9"	40'0"	45'0"	
WEIGHT AND CLASS RAIL					60 C 60 D 66 E 66 F 75 H 75 I	60 D	60 N	80 O 100 P	60 AS 100 AS	60 AS 80 O 80 AS 90 AS 100 AS 110 AS	
			60 D 66 E	66 F							
Original square joint standard.	Ordinary track.	Sleepers per rail	9 No	10 No	10 No	13 No	14 No	12 No	16 No	18 No	
		Spacing A	1'8"	1'8"	1'8"	1'8"	1'8"	1'8"	1'8"	1'8"	
		Spacing C	2'7 $\frac{1}{4}$ "	2'3 $\frac{3}{4}$ "	2'3 $\frac{1}{8}$ "	2'2 $\frac{7}{8}$ "	2'3 $\frac{1}{2}$ "	2'8 $\frac{7}{8}$ "	2'6 $\frac{3}{4}$ "	2'6 $\frac{5}{8}$ "	
	Special track.	Sleepers per rail	-	-	-	-	-	14 No	18 No	20 No	
		Spacing A	-	-	-	-	-	1'8"	1'8"	1'8"	
		Spacing C	-	-	-	-	-	2'3 $\frac{3}{4}$ "	2'3"	2'3 $\frac{3}{8}$ "	
	Re-sleeping standard. Main lines & No. 2 Road.	Square joint track.	Sleepers per rail	11 No	11 No	11 No	14 No	15 No	15 No	19 No	21 No
			Spacing A	1'6"	1'6"	1'6"	1'6"	1'6"	1'6"	1'6"	1'6"
			Spacing B	1'8"	1'8"	1'8"	1'8"	1'8"	1'8"	1'8"	1'8"
			Spacing C	2'2 $\frac{1}{2}$ "	2'2 $\frac{1}{2}$ "	2'3"	2'3"	2'2 $\frac{3}{4}$ "	2'3"	2'2 $\frac{3}{8}$ "	2'2 $\frac{3}{4}$ "
		Equal joint track.	Sleepers per rail	-	-	-	-	-	16 No	-	22 No
			Spacing A	-	-	-	-	-	1'6"	-	1'6"
Spacing B			-	-	-	-	-	1'8"	-	1'8"	
Spacing C			-	-	-	-	-	2'2 $\frac{1}{2}$ "	-	2'2 $\frac{1}{2}$ "	
Unequal joint track.		Sleepers per rail	-	-	-	-	-	16 No	-	23 No	
		Spacing A	-	-	-	-	-	1'6"	-	1'6"	
		Spacing B	-	-	-	-	-	1'8"	-	1'8"	
		Spacing C	-	-	-	-	-	2'2 $\frac{1}{2}$ "	-	2'1"	

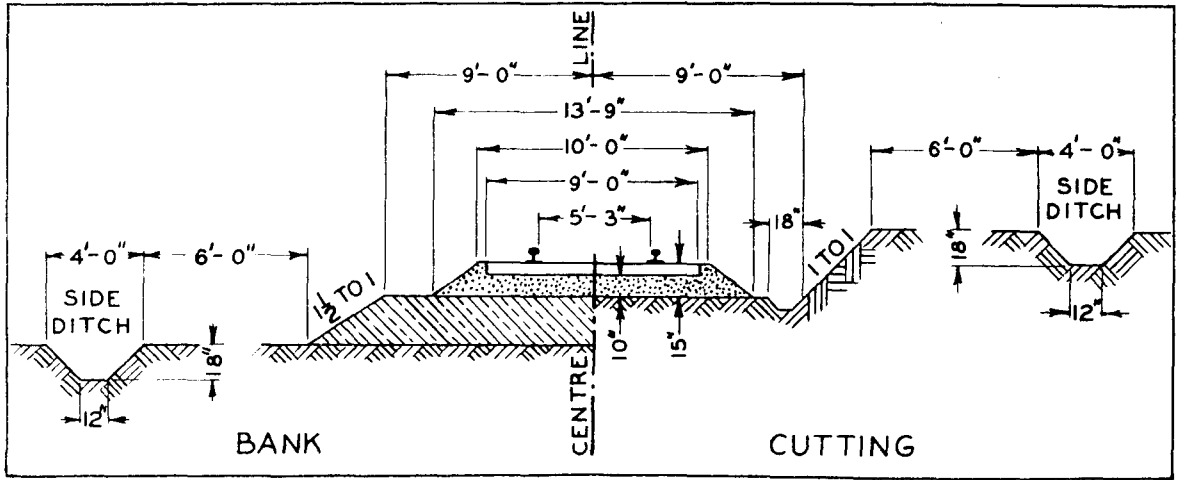

FIG.1. THE MINIMUM TRACK SECTION FOR 1ST CLASS LINES - 5'-3" GAUGE

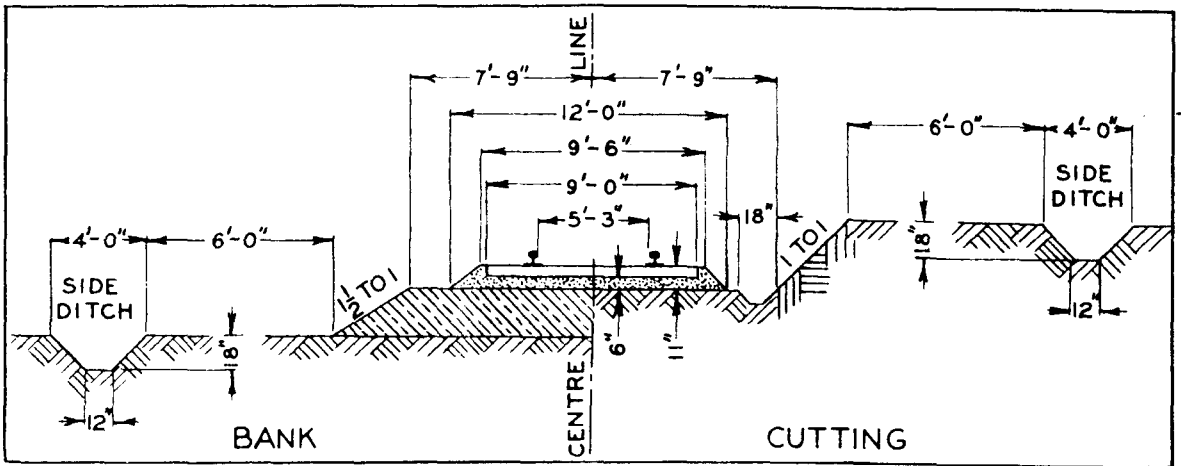

FIG.2. THE MINIMUM TRACK SECTION FOR 2ND CLASS LINES - 5'-3" GAUGE

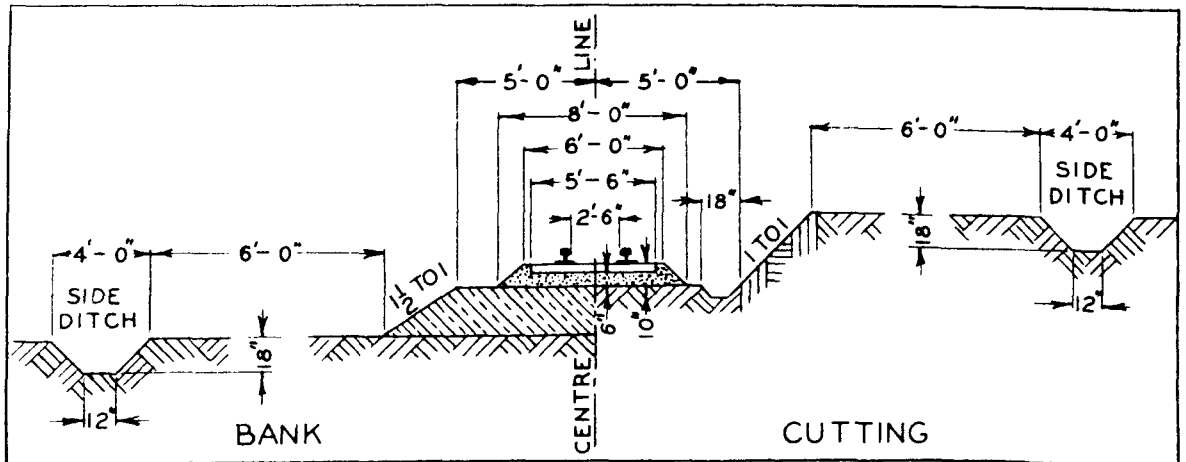

FIG.3. THE MINIMUM TRACK SECTION FOR NARROW GAUGE - 2'-6" GAUGE

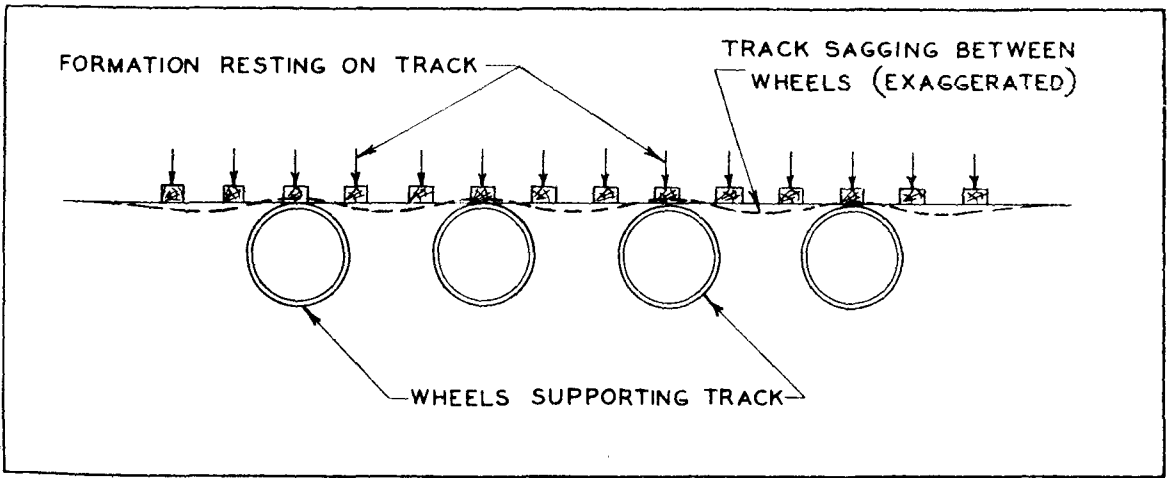

FIG. 4. FLEXURE OF TRACK CONSIDERED INVERTED

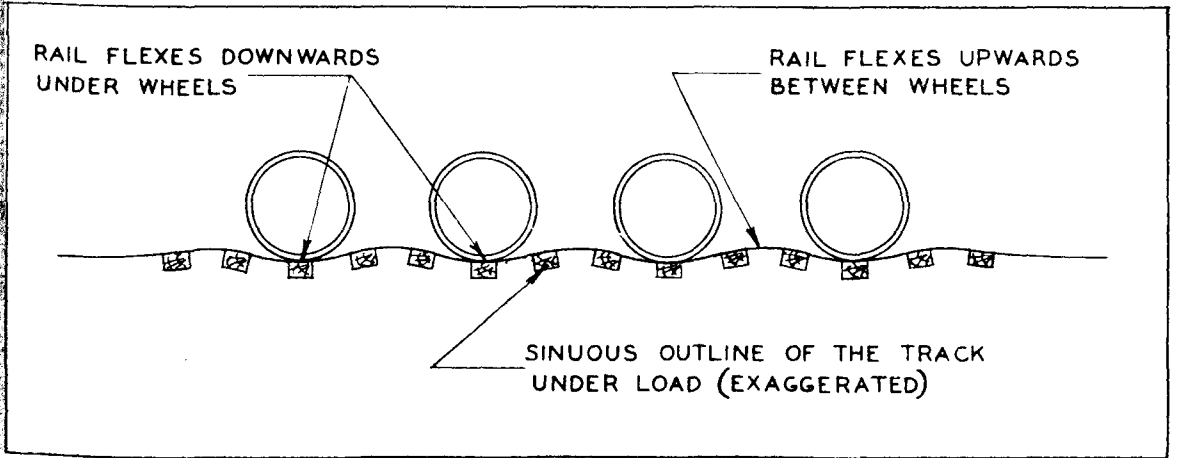

FIG. 5. FLEXURE OF TRACK UNDER TRAFFIC - EXAGGERATED

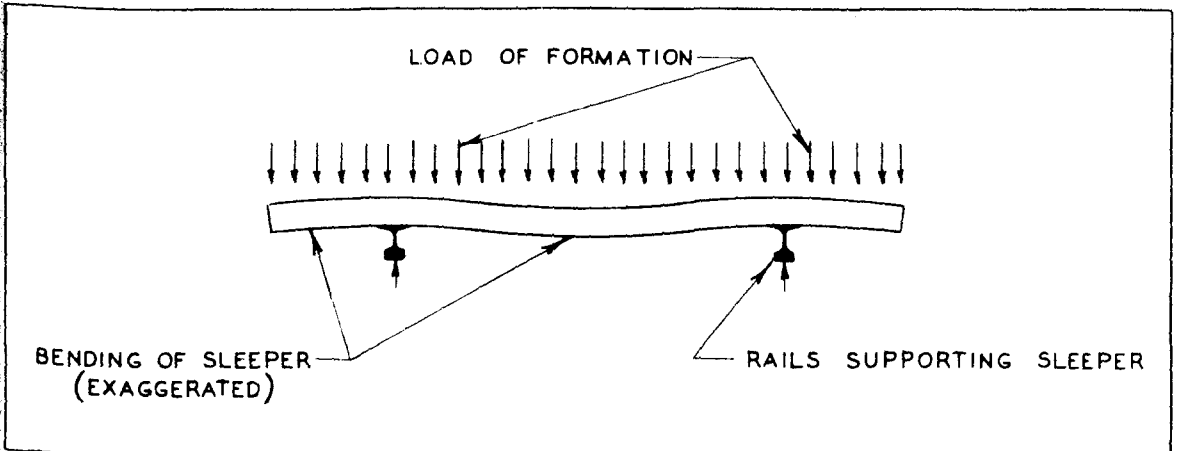

FIG. 6. FLEXURE OF SLEEPER CONSIDERED INVERTED

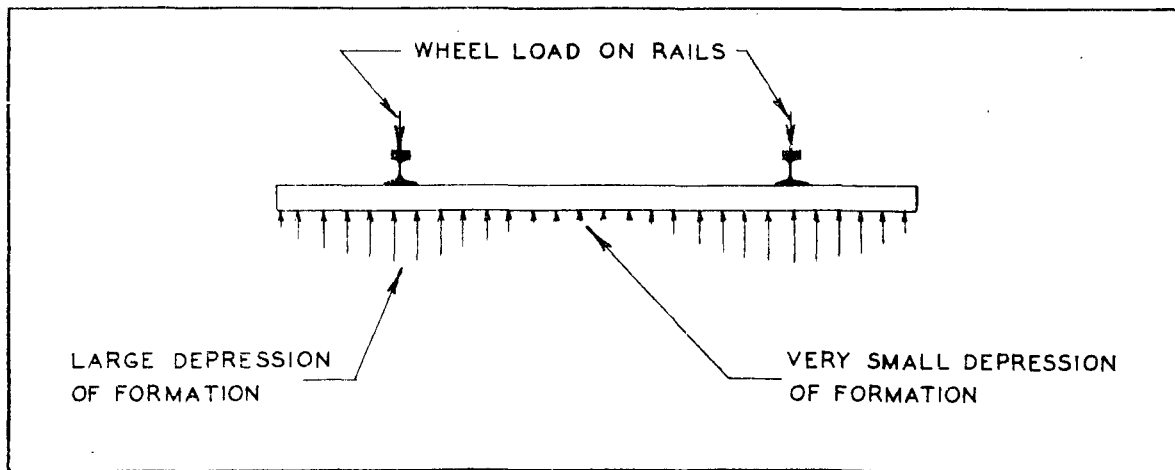

FIG. 7. THE DEPRESSION OF THE FORMATION UNDER TRAFFIC

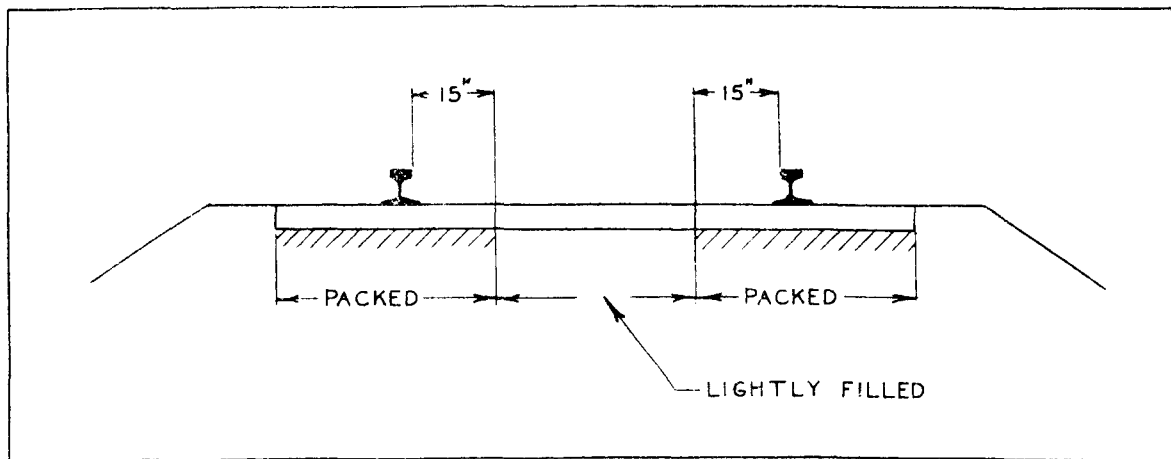

FIG. 8. LOCATION OF PACKING IN RESPECT TO THE SLEEPER

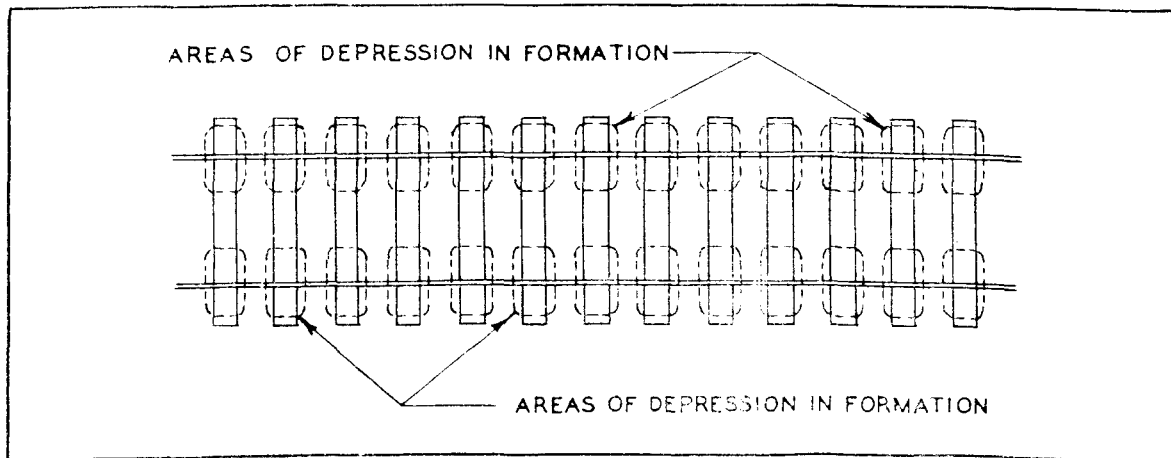

FIG. 9. THE AREAS OF DEPRESSION IN THE FORMATION

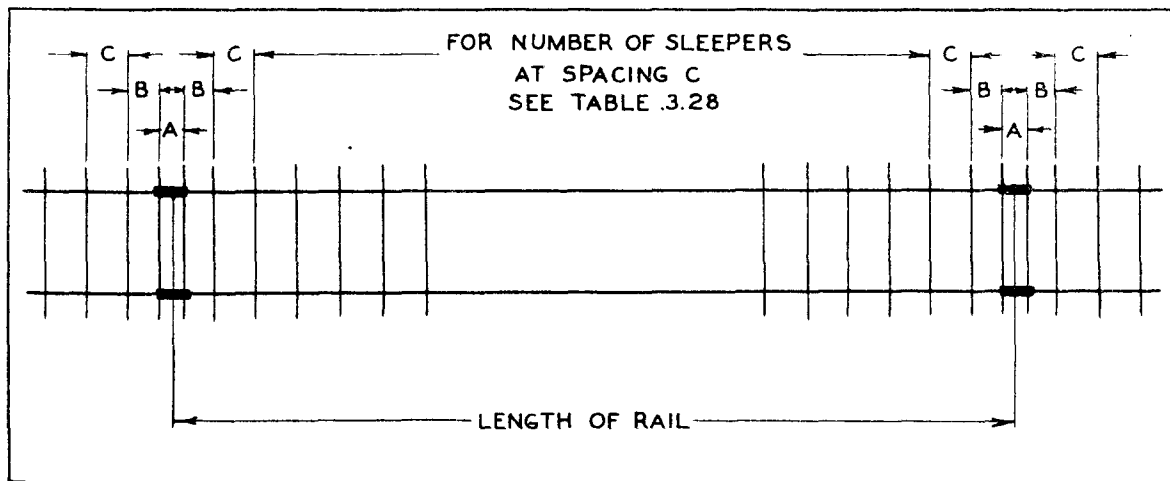

FIG.10. THE SQUARE JOINT SHORT RAIL TRACK

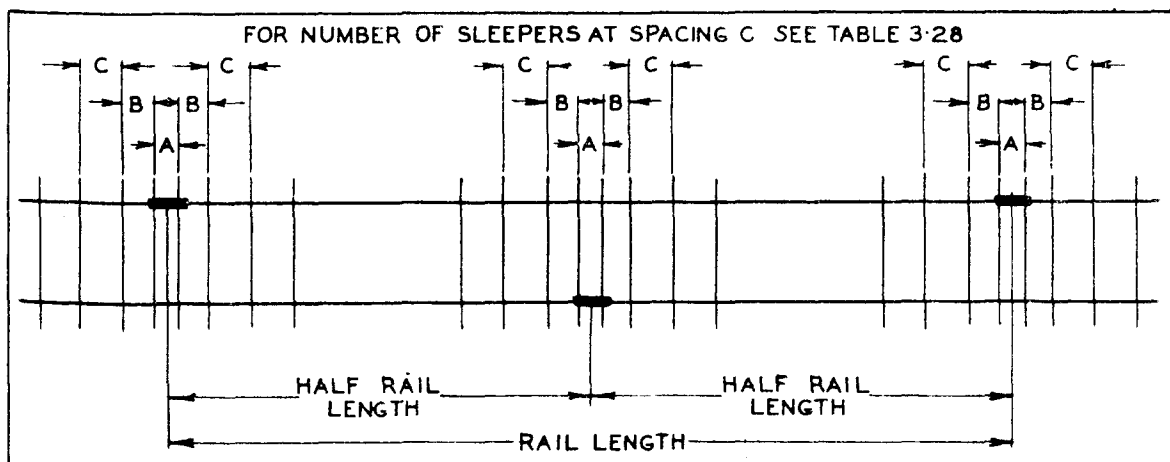

FIG.11. THE EQUAL STAGGER JOINT SHORT RAIL TRACK

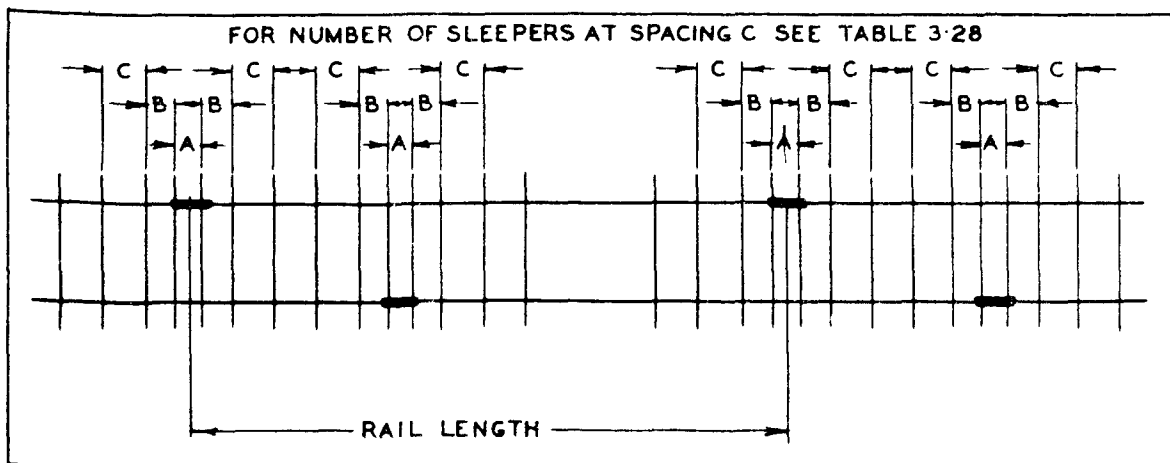

FIG.12. THE UNEQUAL STAGGER JOINT SHORT RAIL TRACK

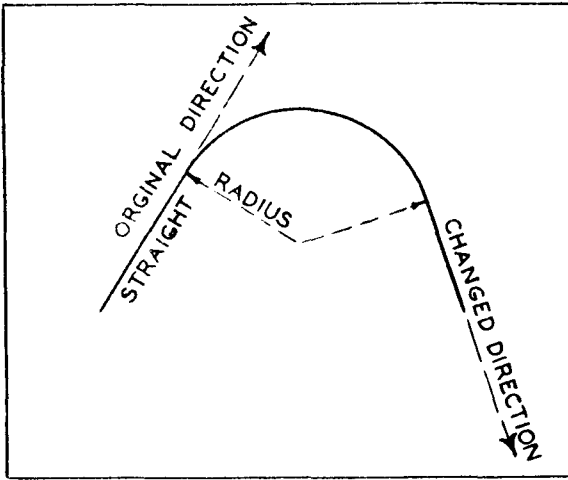

FIG.13. THE SIMPLE CURVE

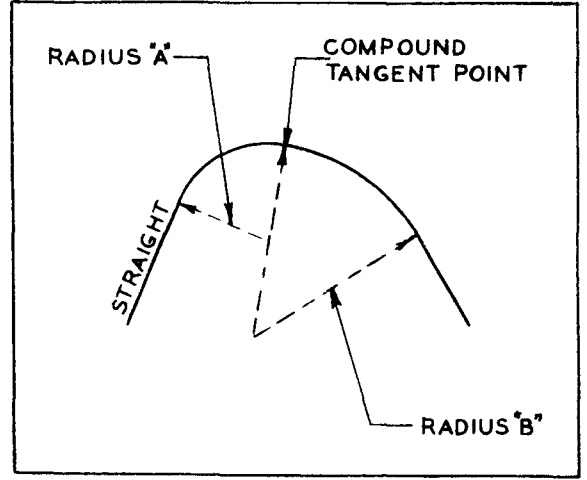

FIG.16. THE COMPOUND CURVES

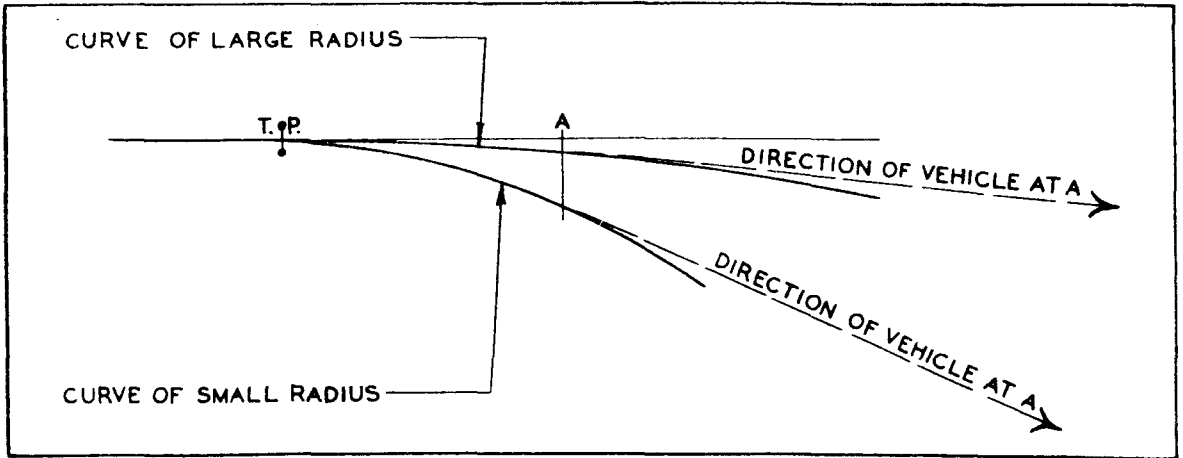

FIG.14. THE EFFECT OF RADIUS ON CHANGE OF DIRECTION

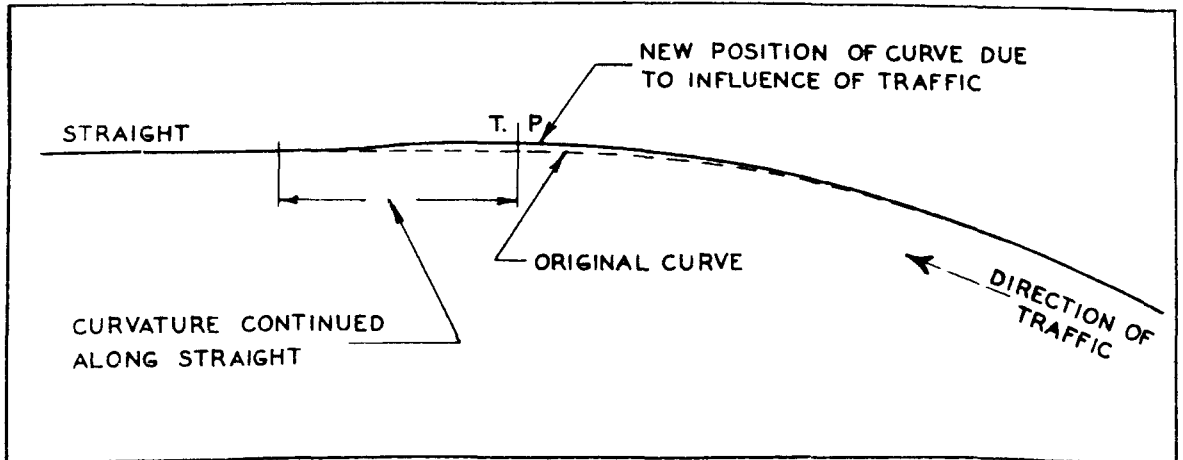

FIG.15. THE EFFECT OF TRAFFIC AT THE TANGENT POINT OF CURVE

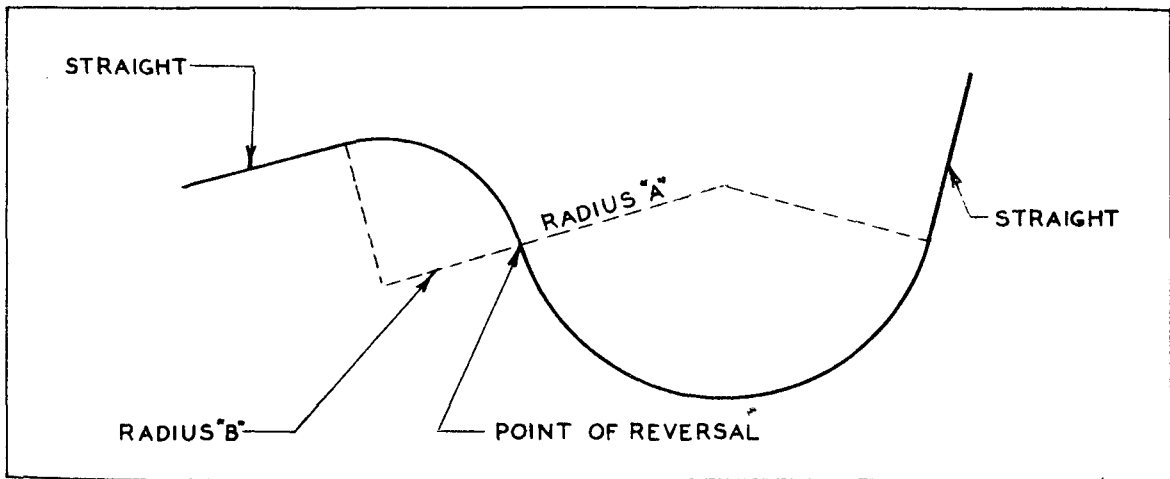

FIG.17. REVERSE CURVES

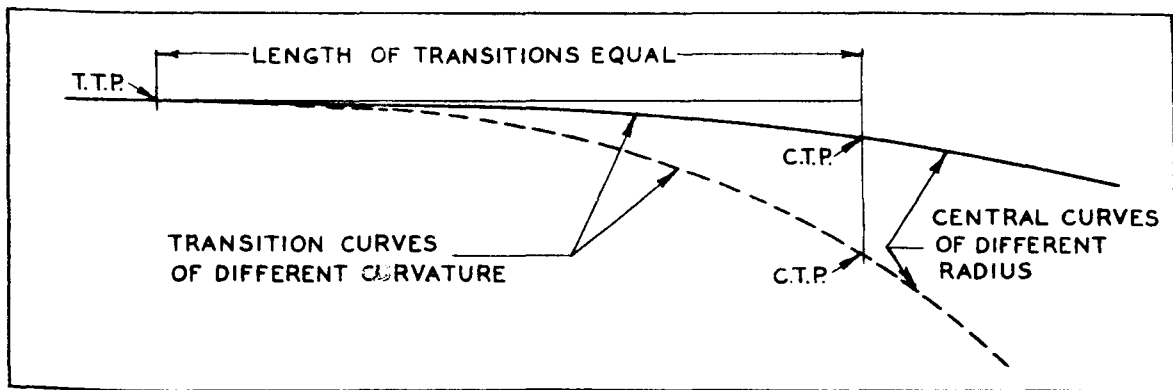

FIG.18. COMPARISON BETWEEN TWO TRANSITIONS

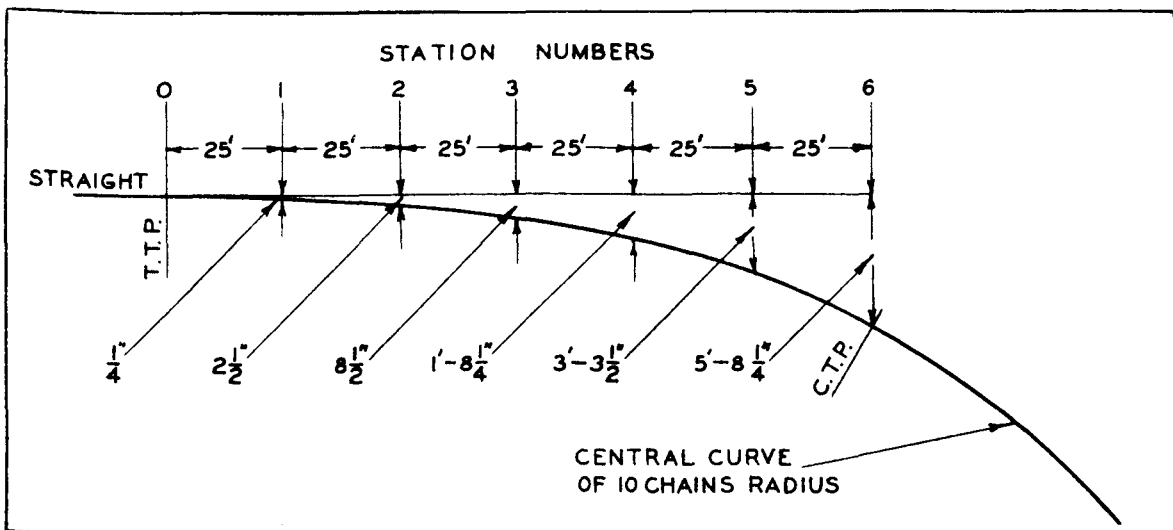

FIG.19. A TYPICAL 150' TRANSITION CURVE

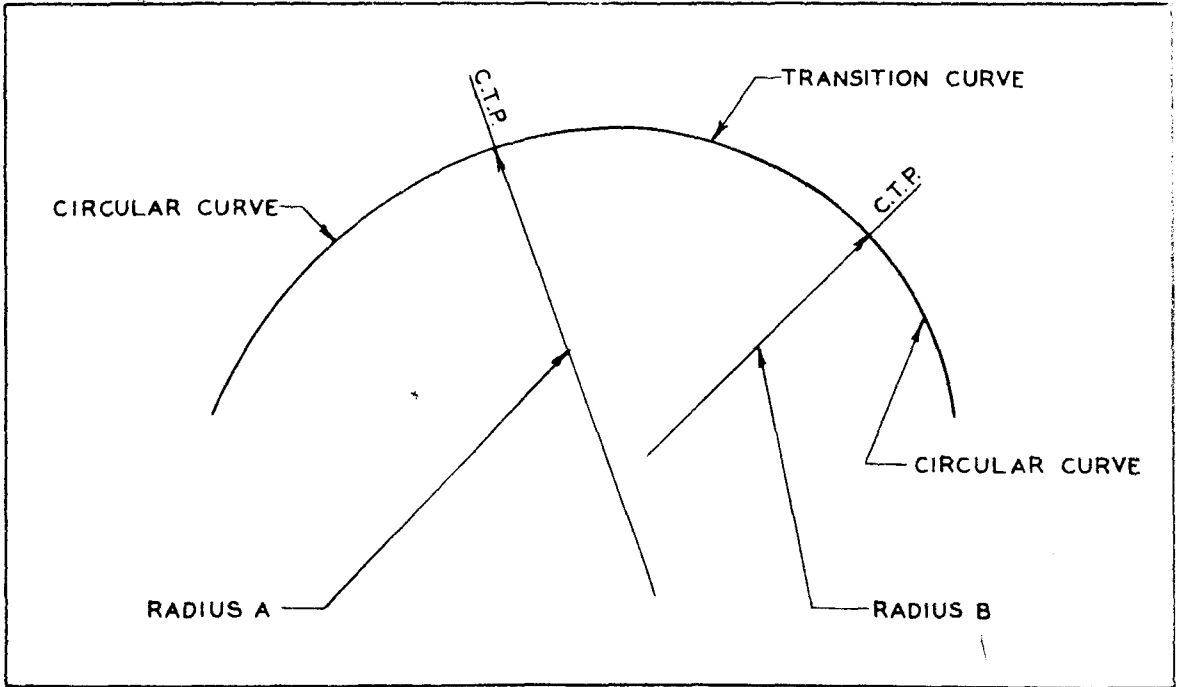

FIG. 20. A TRANSITION CURVE BETWEEN COMPOUND CIRCULAR CURVES

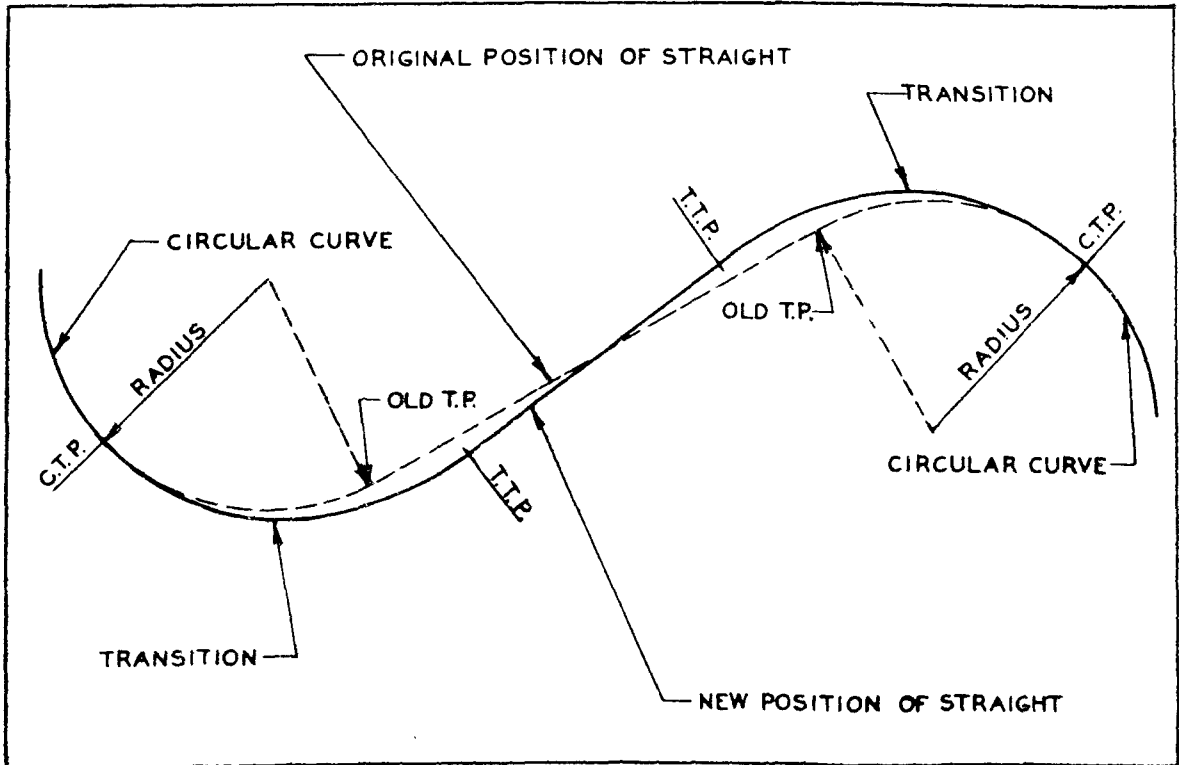

FIG. 21. A TRANSITION BETWEEN REVERSE CURVES

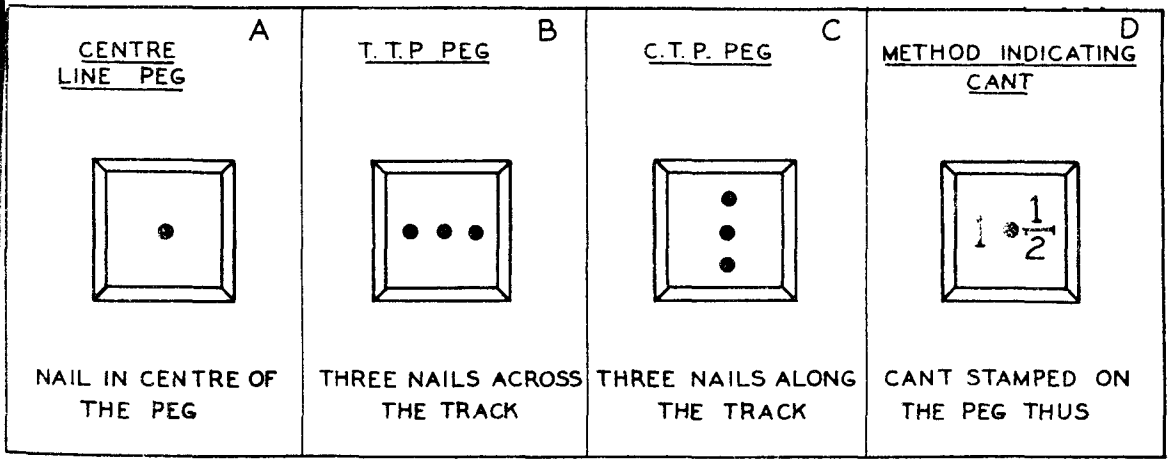

FIG.22. CURVE PEGS

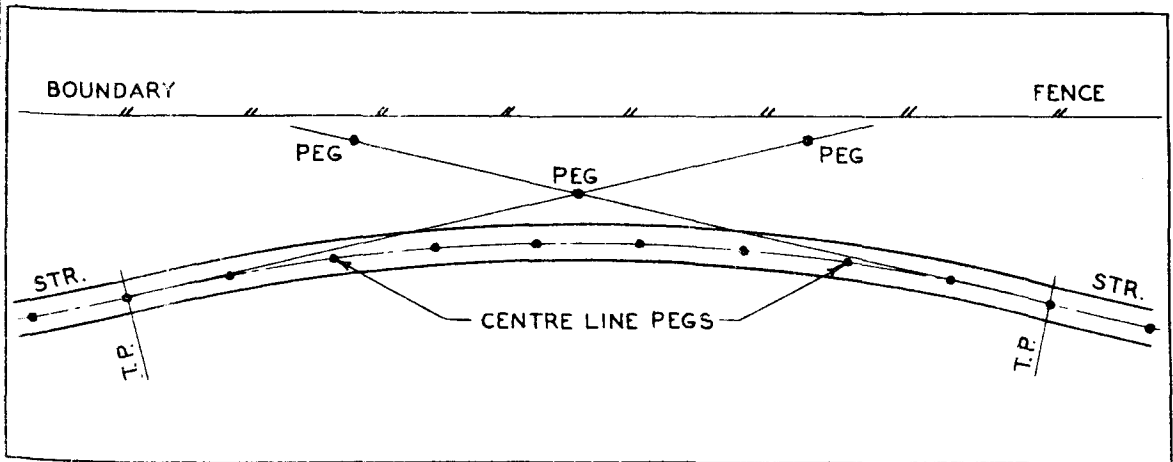

FIG.23. METHOD OF PEGGING THE PROLONGATIONS OF THE TANGENTS

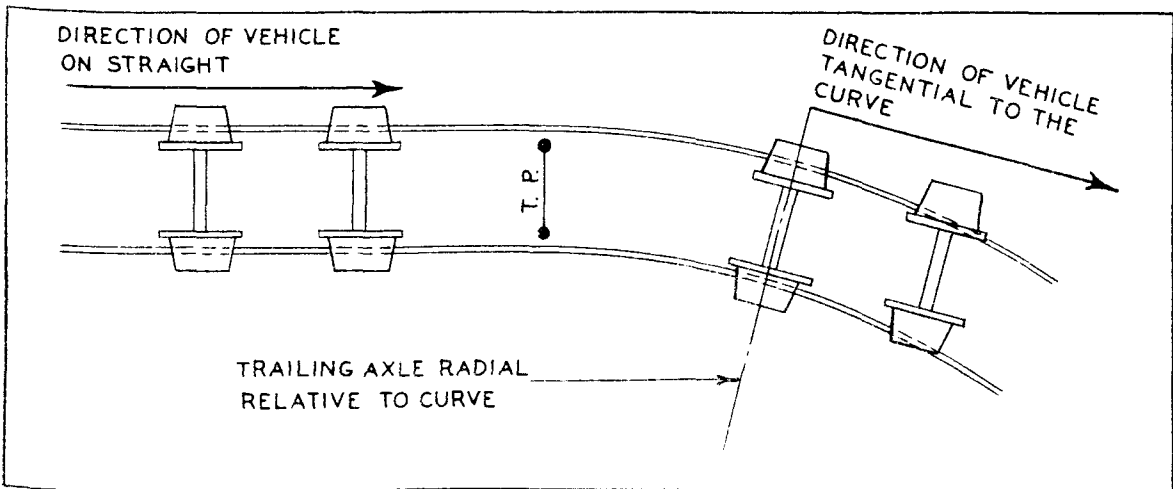

FIG.24. POSITION OF A TWO AXLE VEHICLE ON A CURVE AND STRAIGHT TRACK

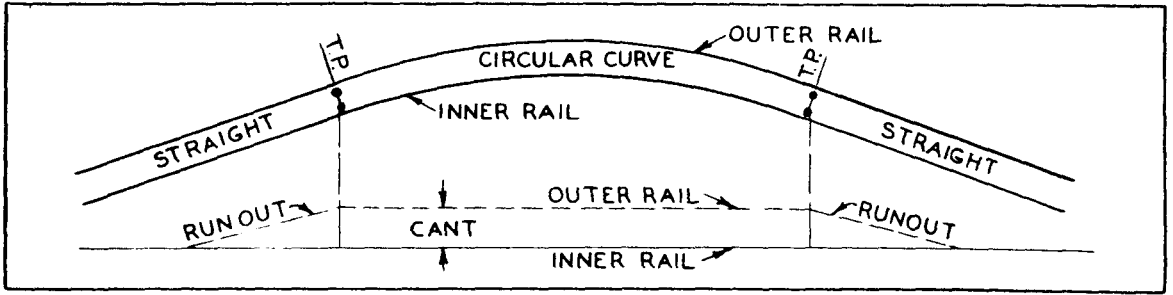

FIG. 25. RUNOUT OF CANT.— CIRCULAR CURVES

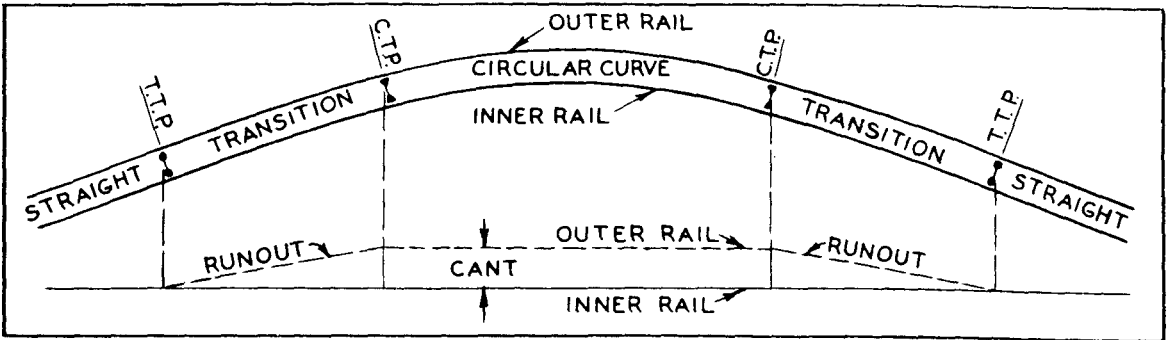

FIG. 26. RUNOUT OF CANT— TRANSITION CURVES

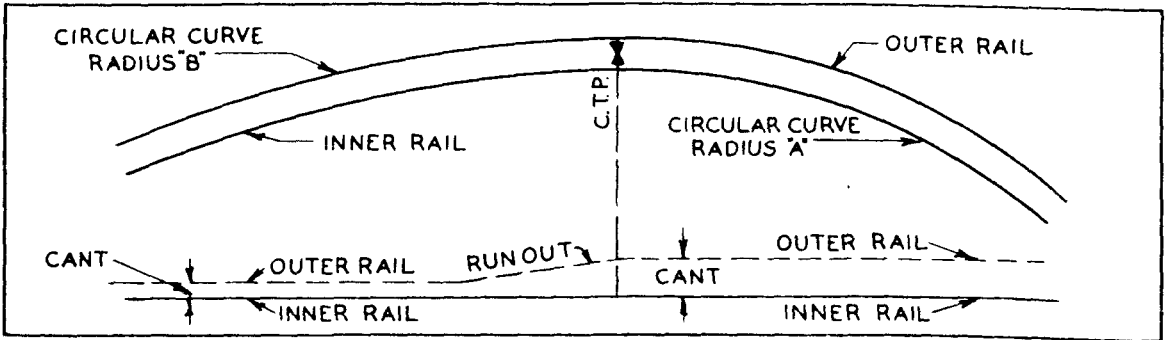

FIG. 27. RUNOUT OF CANT— COMPOUND CURVES

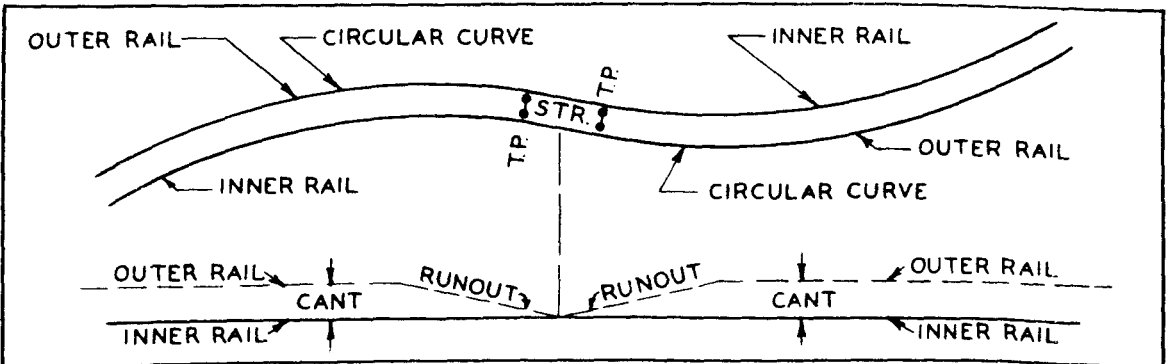

FIG. 28. RUNOUT OF CANT— REVERSE CURVES

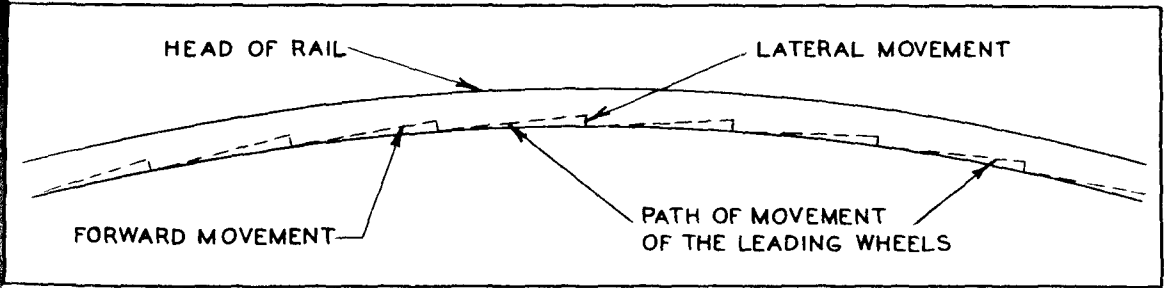

FIG.29. PATH OF MOTION OF THE LEADING WHEELS ON THE RAIL HEAD

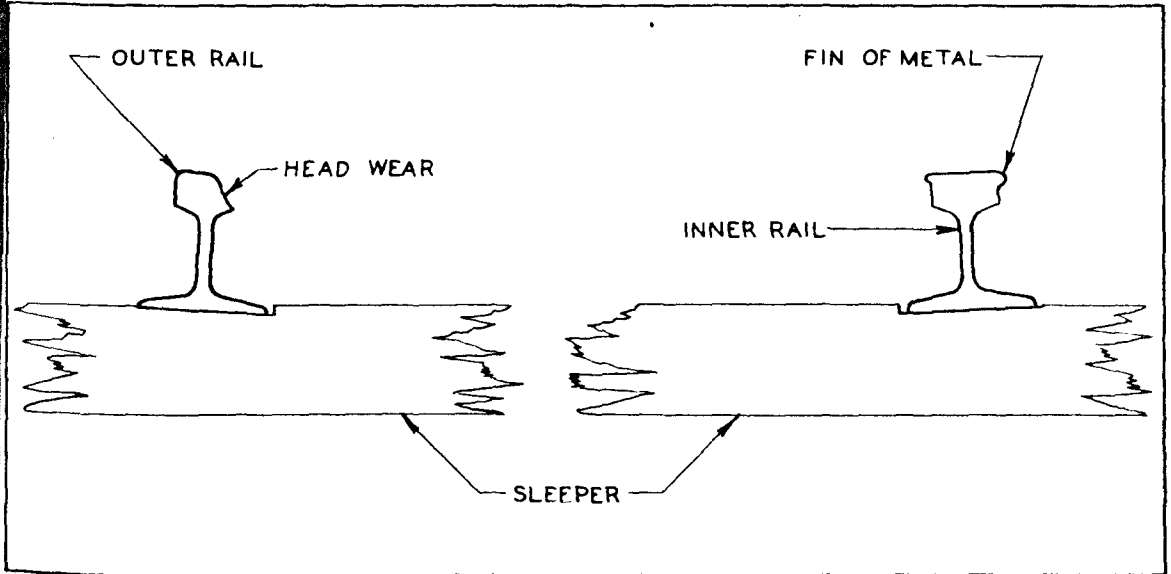

FIG.30. HEAD WEAR DUE TO LATERAL WHEEL MOVEMENTS

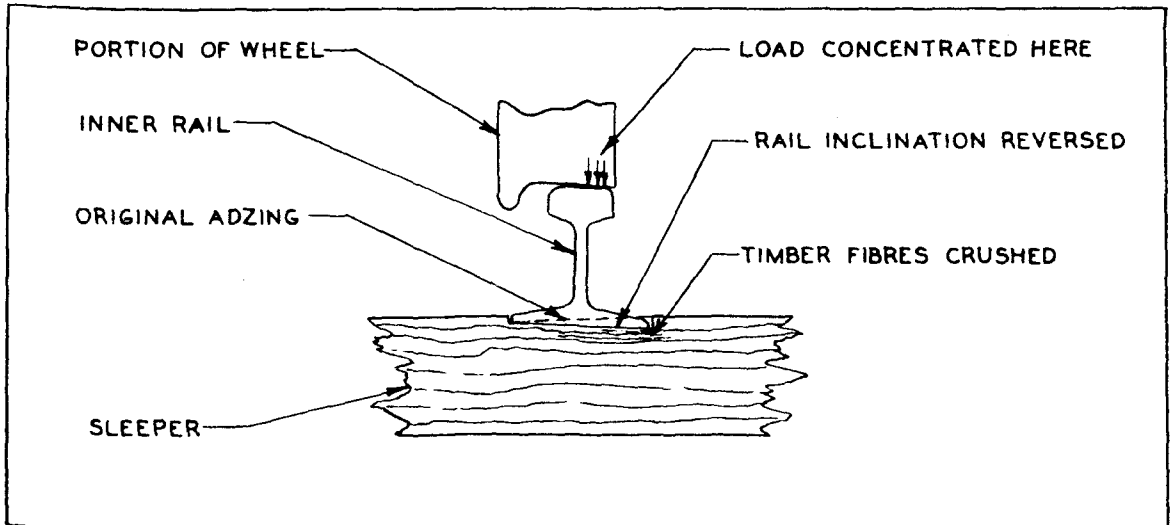

FIG.31. THE EFFECT OF LATERAL MOVEMENT ON RAIL INCLINATION

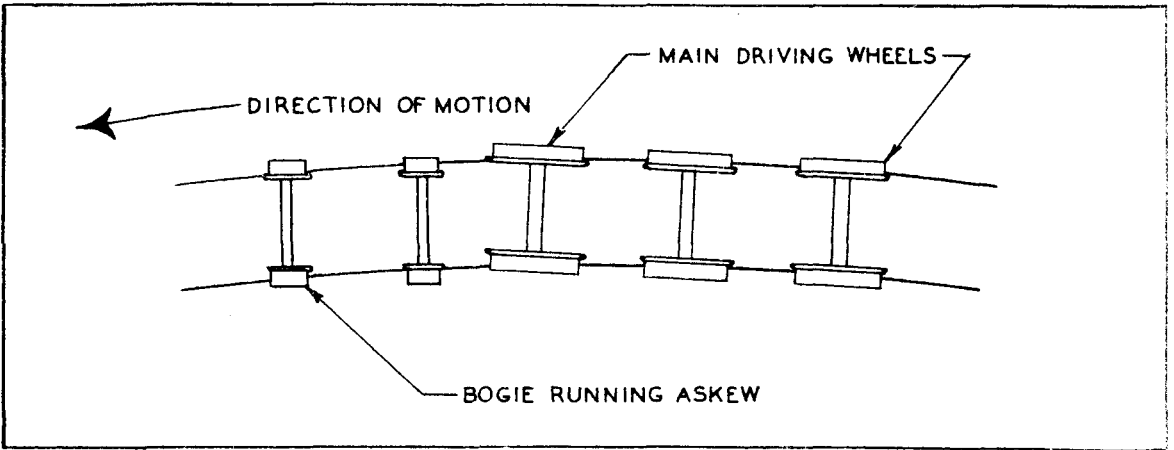

FIG. 32. HOW THE SHORT WHEELBASE PERMITS BOGIE TO RUN ASKEW

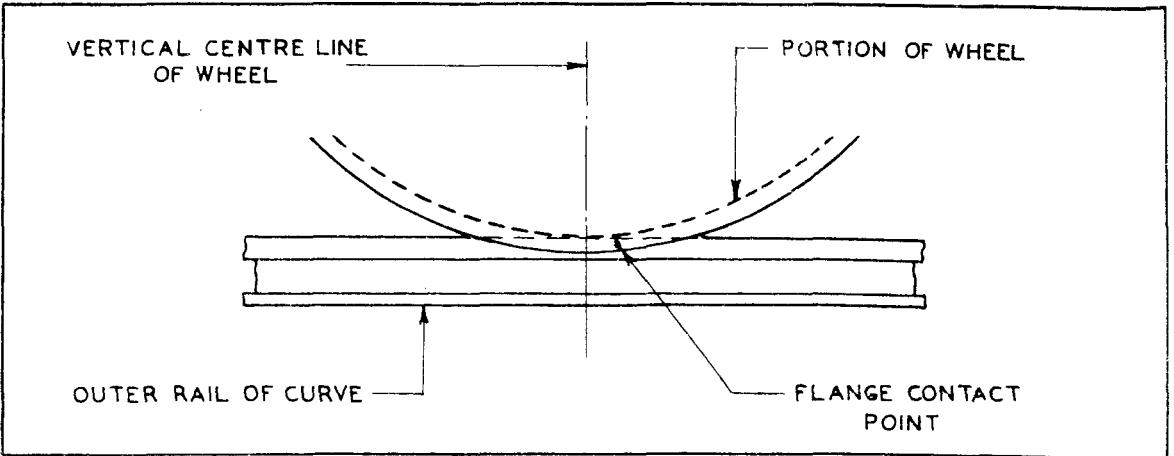

FIG. 33. POSITION OF FLANGE CONTACT POINT

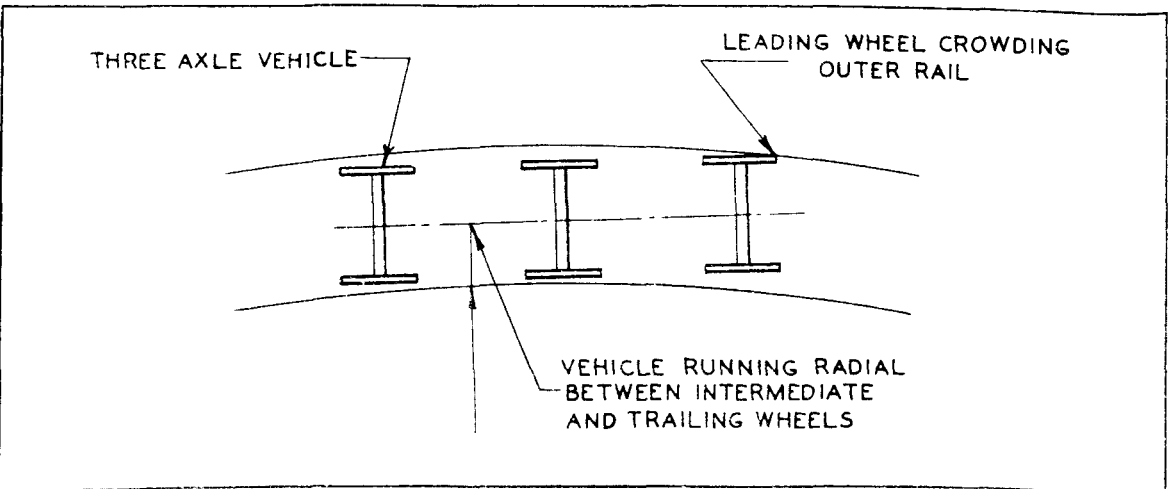

FIG. 34. POSITION OF WHEELS OF A THREE AXLE VEHICLE

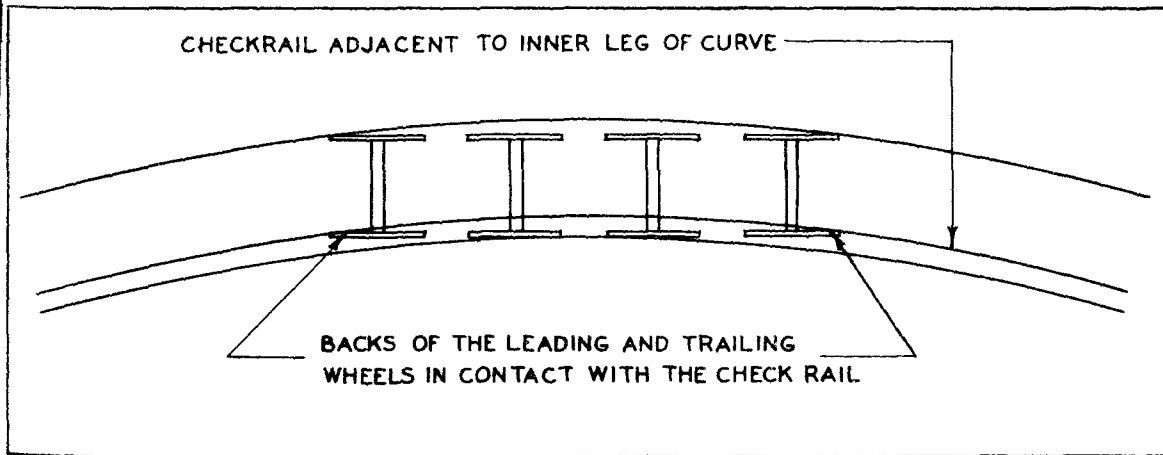

FIG.35. CHECKRAIL ON INNER LEG - INFLUENCE ON ROLLING STOCK

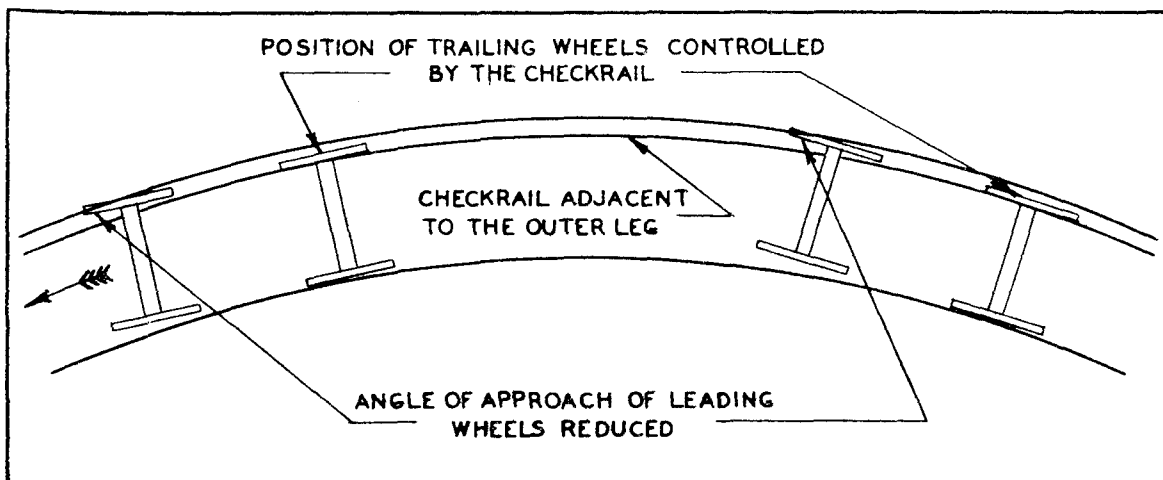

FIG.36. CHECKRAIL ON OUTER LEG - INFLUENCE ON BOGIE STOCK

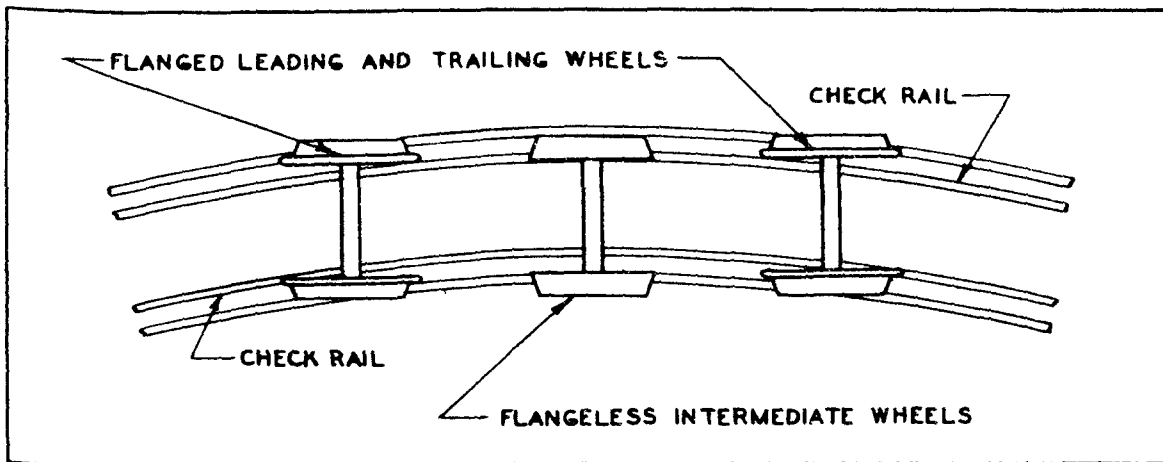

FIG.37. THE USE OF DOUBLE CHECK RAILS

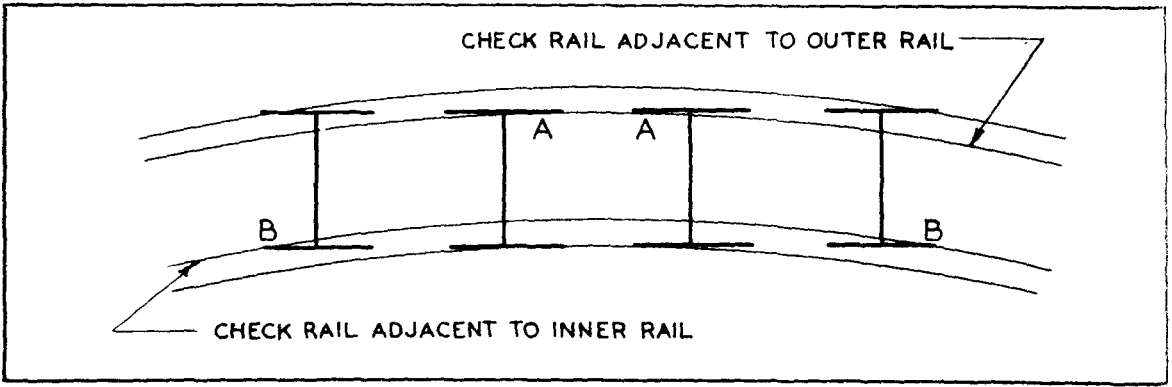

FIG. 38. INFLUENCE OF LOCO. WHEELBASE ON CHECK RAIL FLANGWAYS

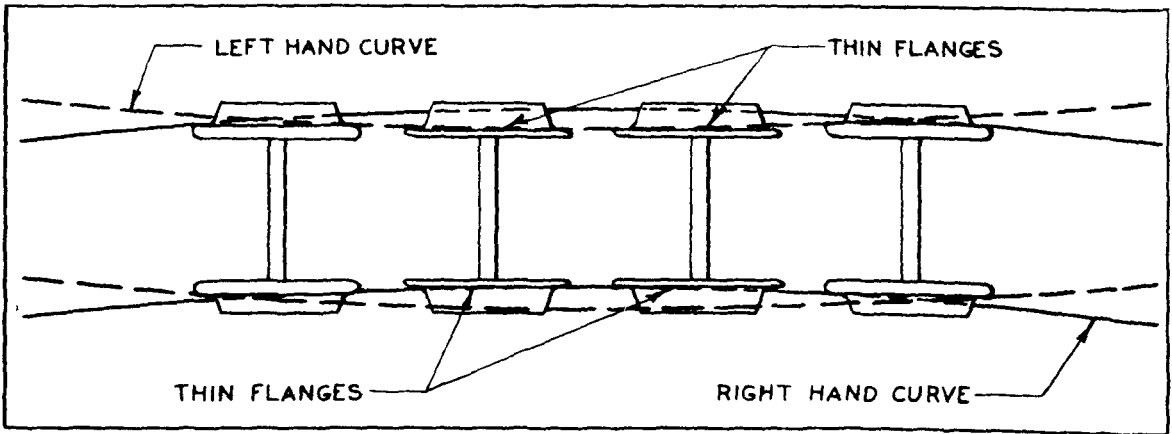

FIG. 39. WHY THIN INTERMEDIATE FLANGES ARE USED

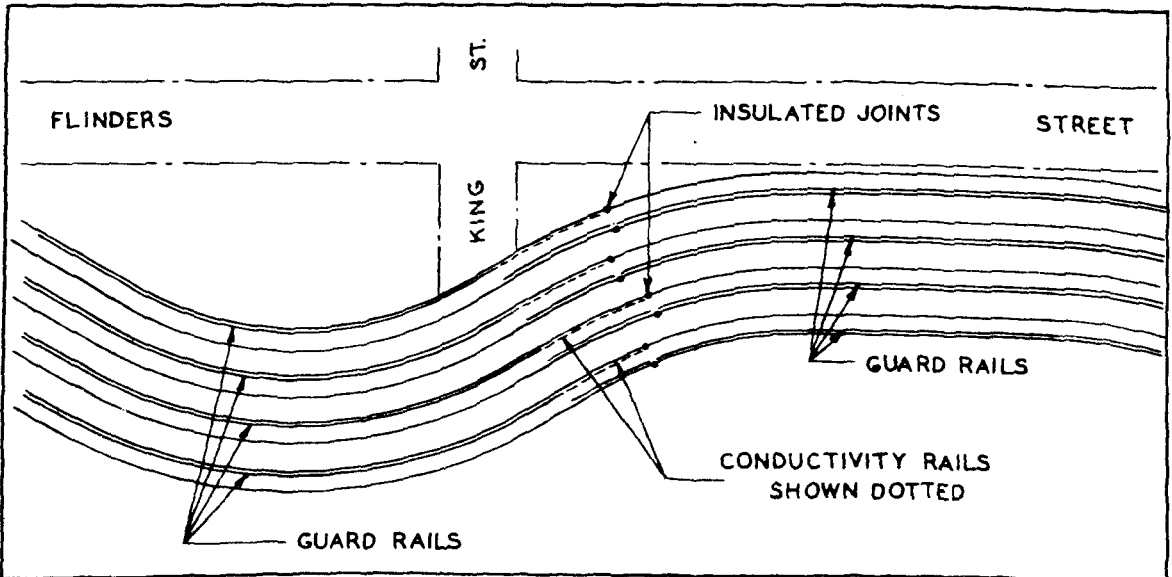

FIG. 40. ARRANGEMENT OF CONDUCTIVITY RAILS—FLINDERS ST. VIADUCT

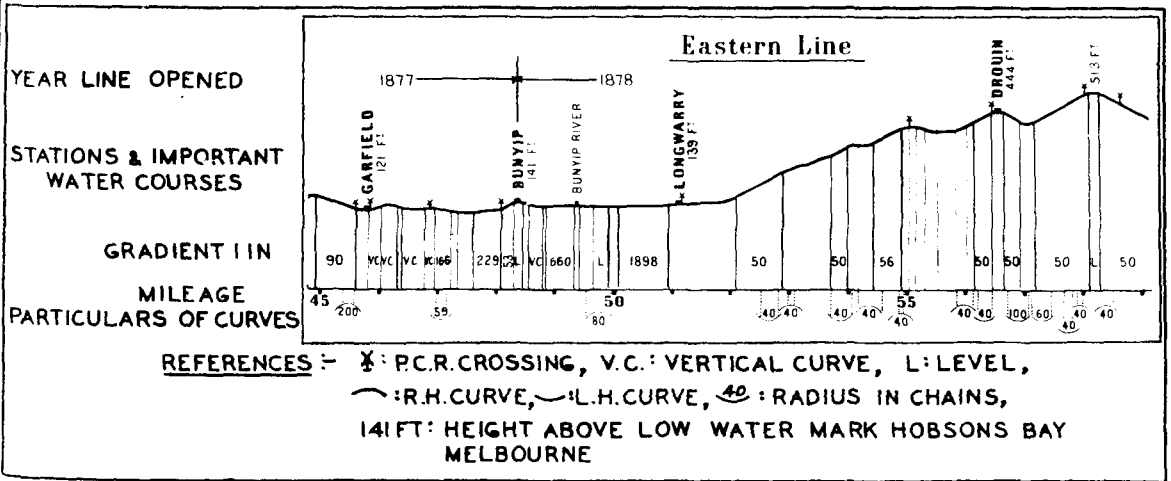

FIG. 41. TYPICAL SECTION OF GRADES — EASTERN LINE

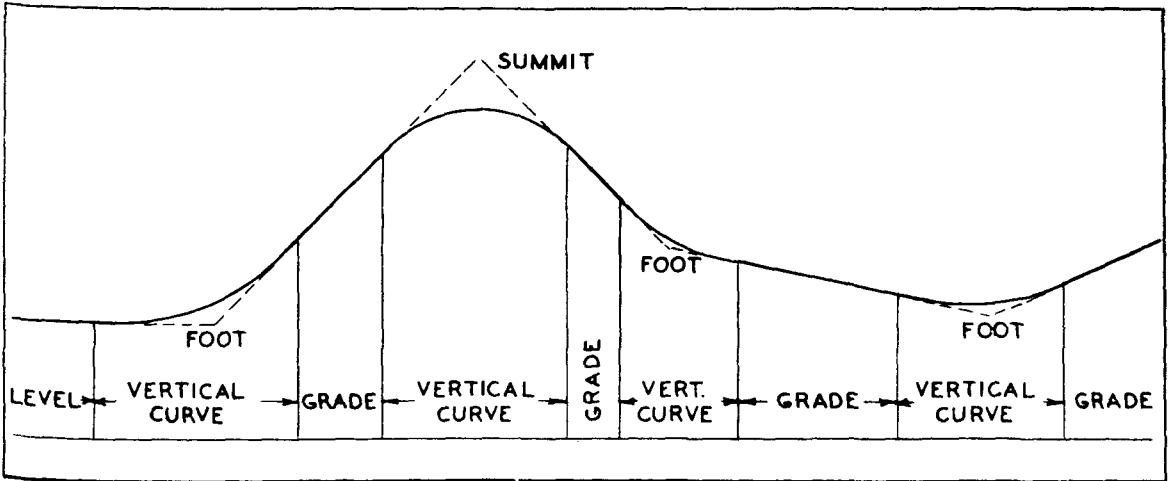

FIG. 42. VERTICAL CURVES

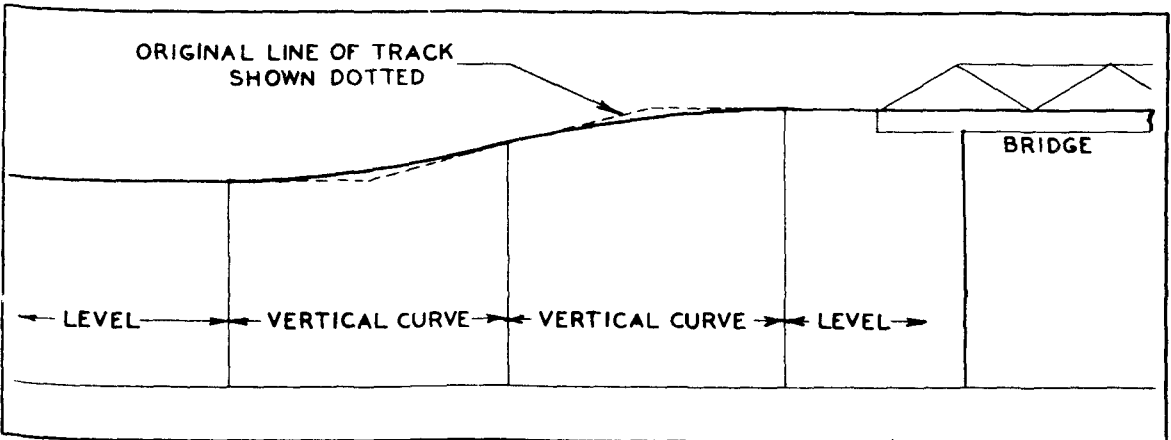

FIG. 43. THE INTRODUCTION OF VERTICAL CURVES AT BRIDGE APPROACHES

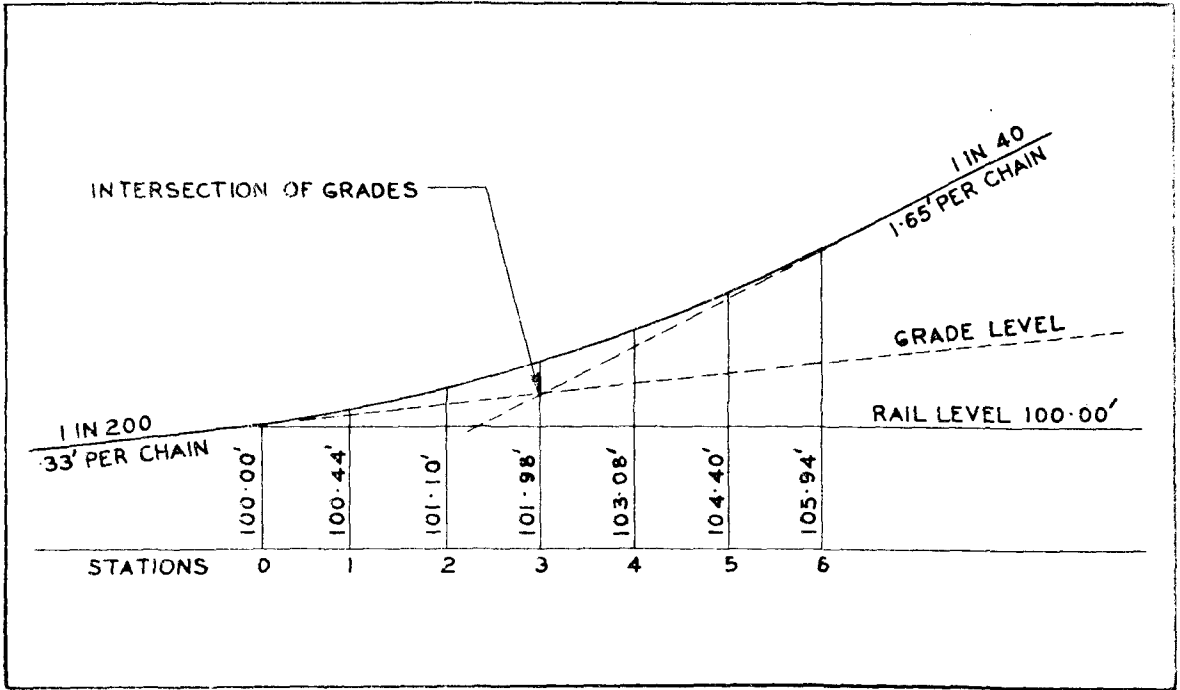

FIG. 44. AN EXAMPLE OF A VERTICAL CURVE IN A SAG

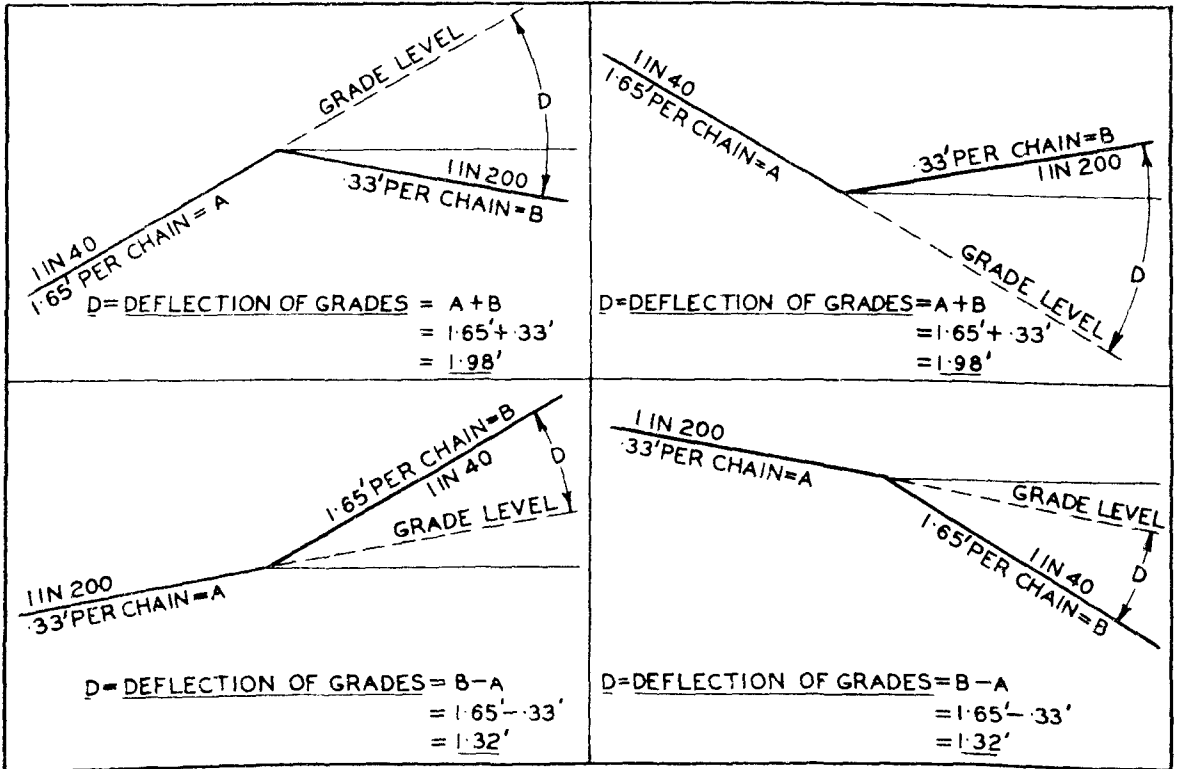

FIG. 45. DEFLECTION OF GRADES

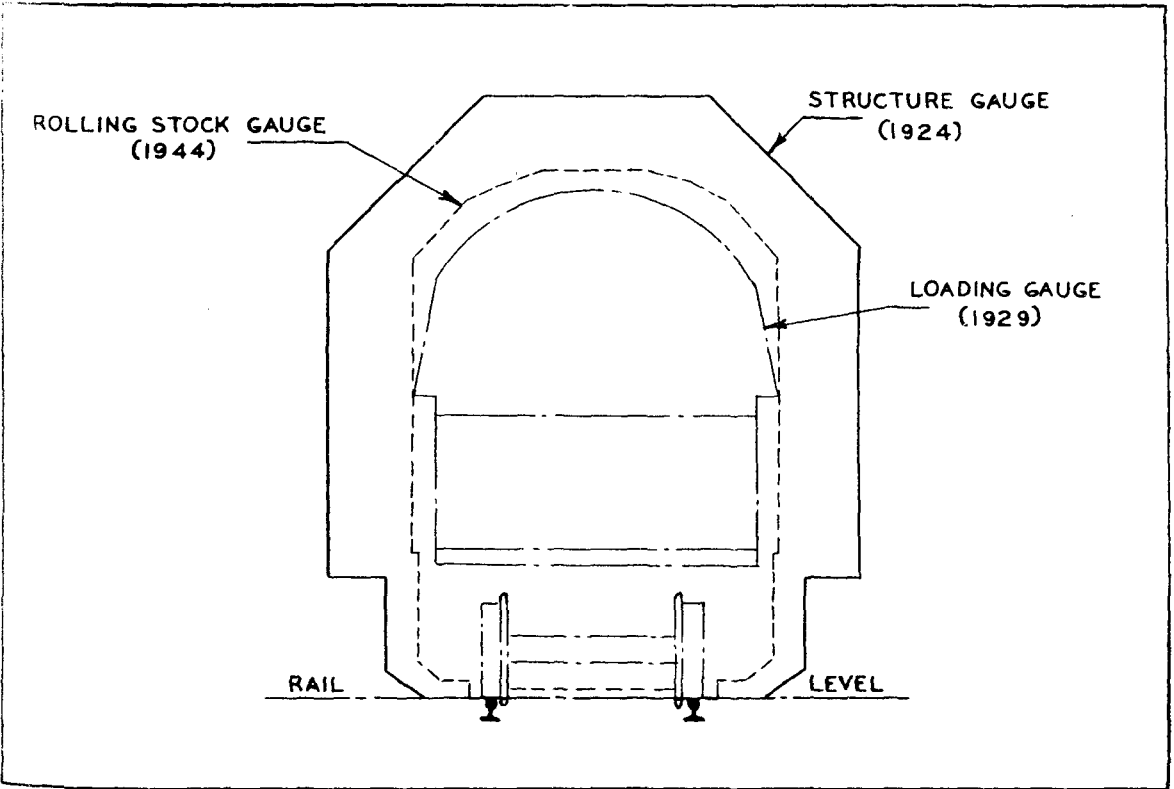

FIG. 46. THE STRUCTURE, LOADING & ROLLING STOCK GAUGES - 5'-3" TRACKS

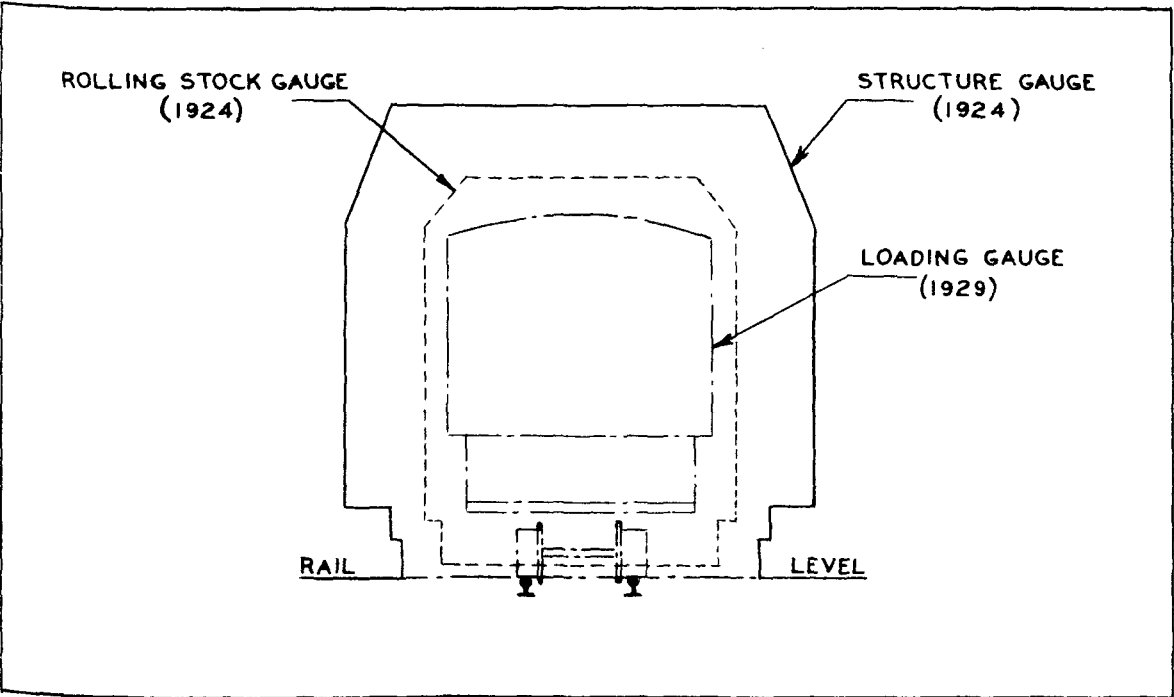

FIG. 47. THE STRUCTURE, LOADING & ROLLING STOCK GAUGES - 2'-6" TRACKS

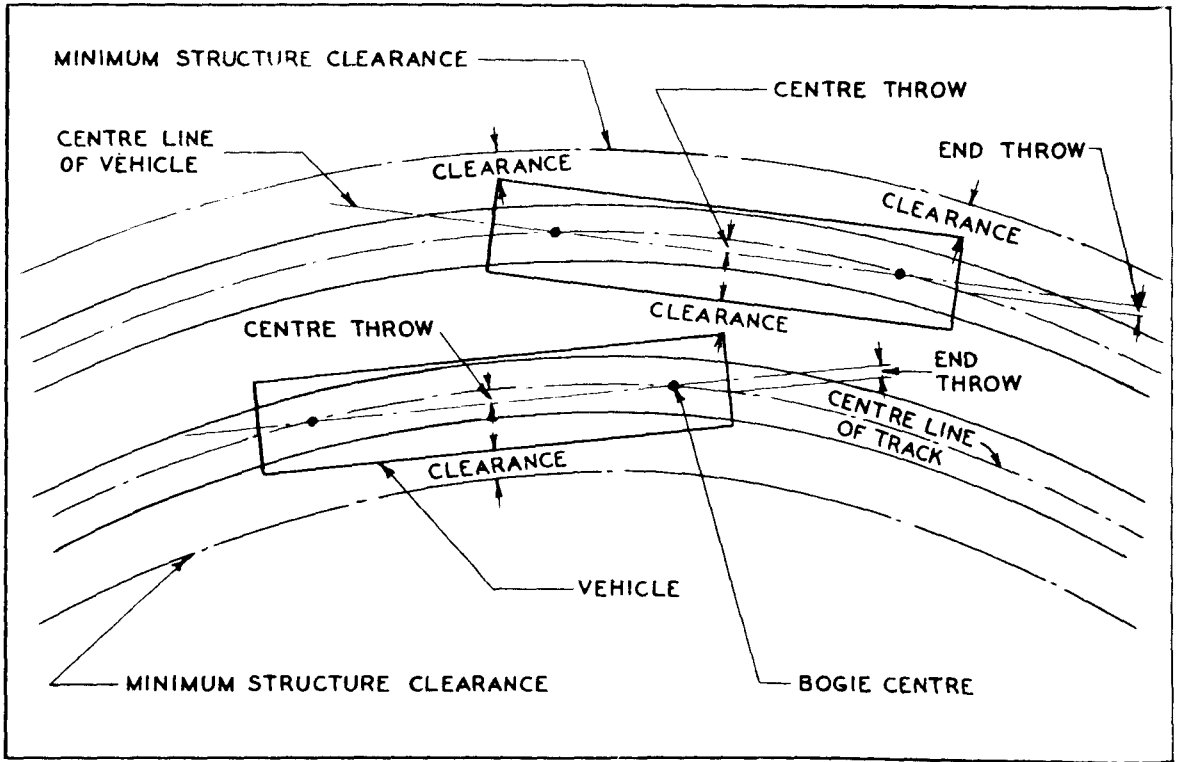

FIG. 48. THE CLEARANCES OF VEHICLE ON CURVES

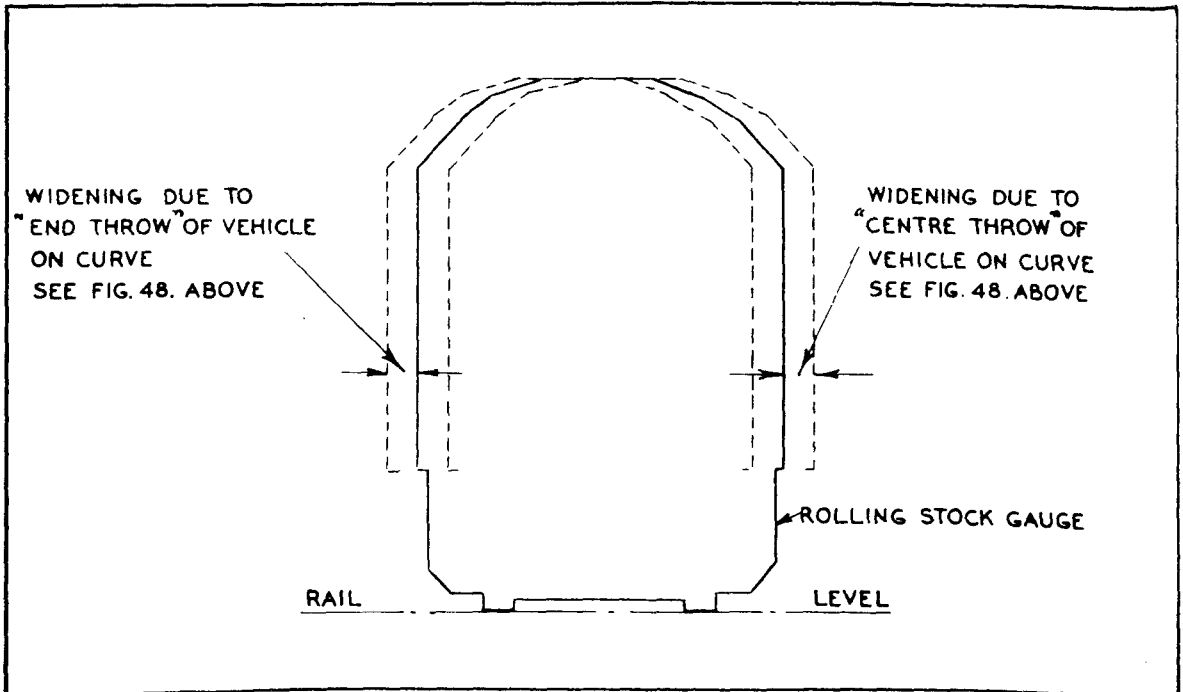

FIG. 49. THE EFFECT OF CENTRE AND END THROWS ON THE VEHICLE OUTLINE

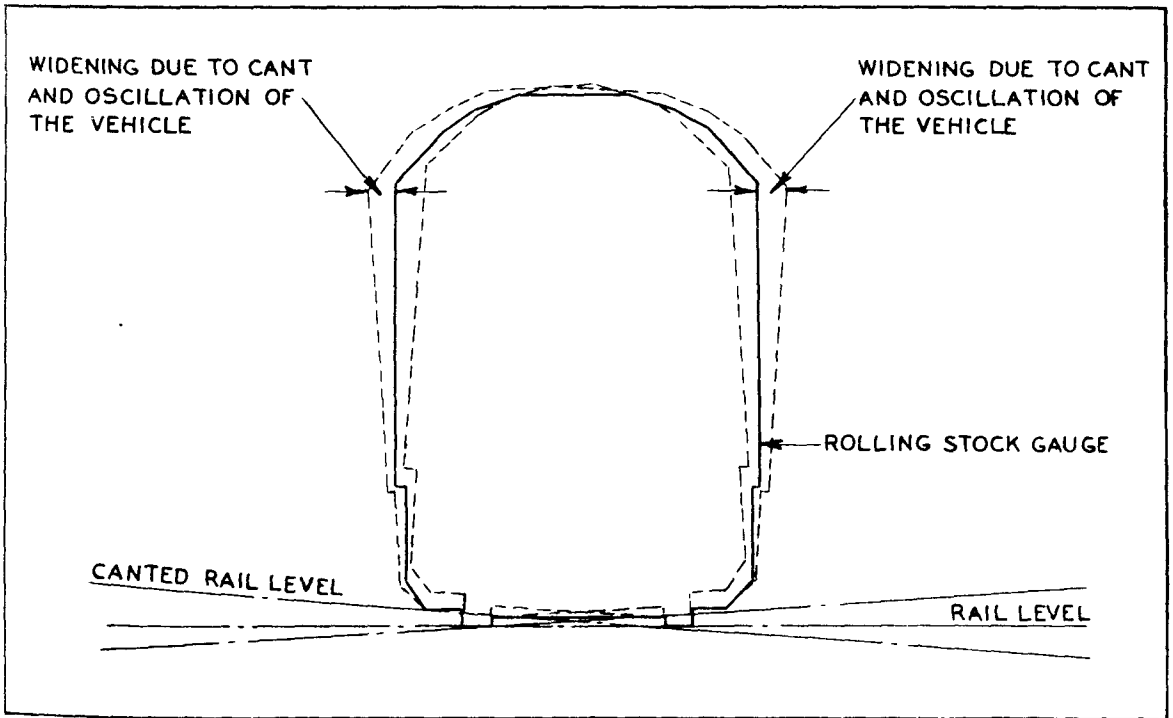

FIG. 50. THE EFFECT OF CANT AND OSCILLATION OF VEHICLE

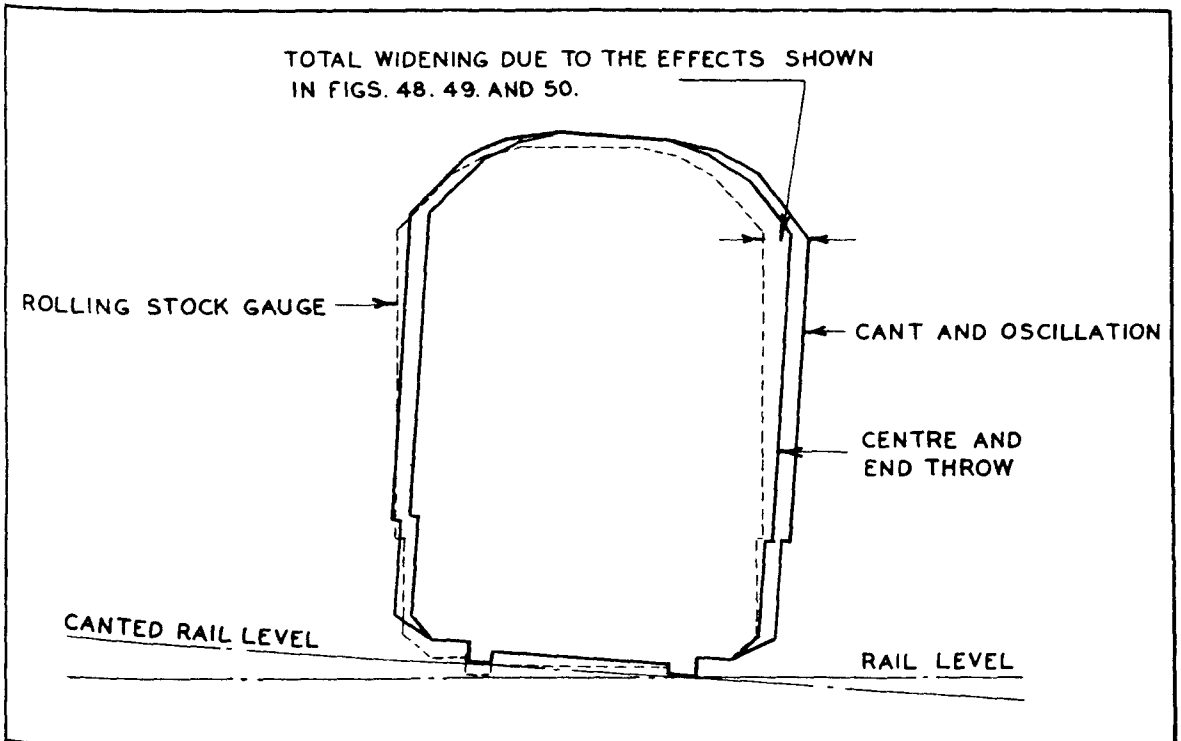

FIG. 51. THE TOTAL EFFECT OF CANT, OSCILLATION, CENTRE THROW AND END THROW

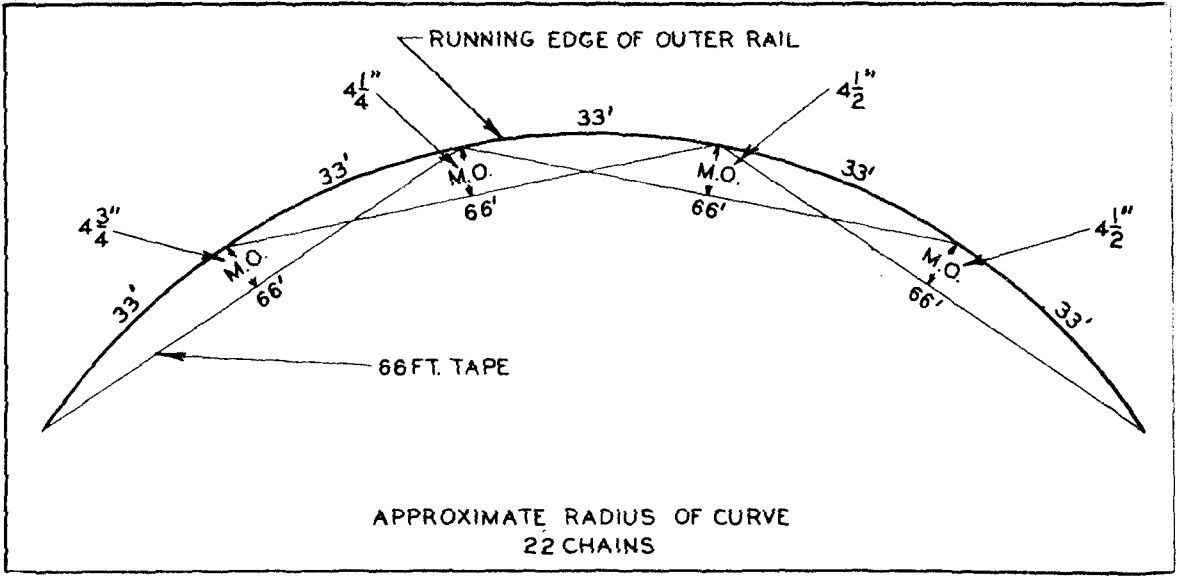

FIG. 52. THE APPROXIMATE METHOD OF DETERMINING RADIUS

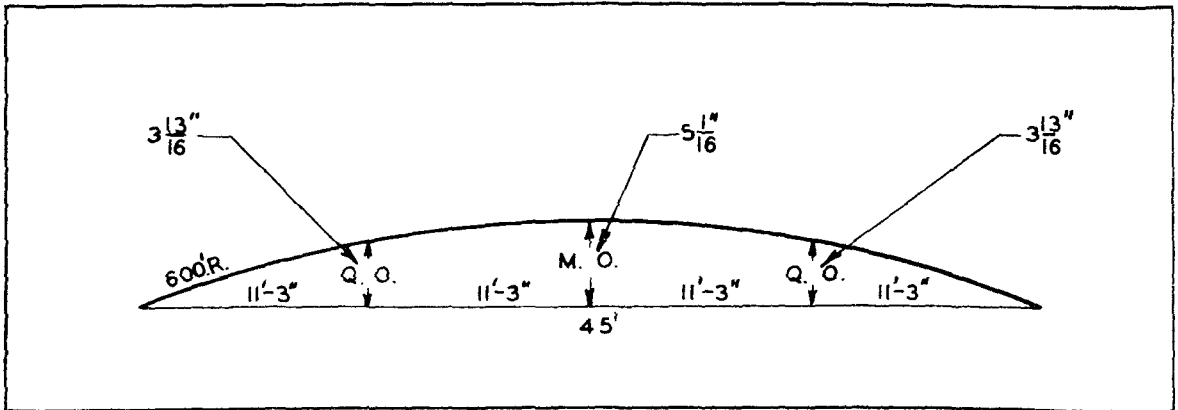

FIG. 53. OFFSET METHOD FOR CURVING SHORT RAILS

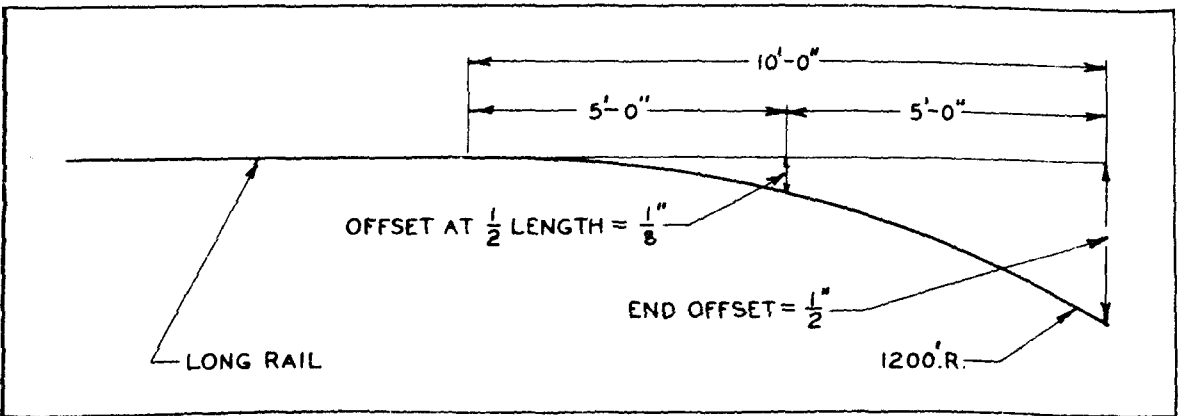

FIG. 54. METHOD OF MEASURING OFFSETS - ENDS OF LONG RAILS

SIGNS & STRUCTURES. 4.

PURPOSE

The purpose and arrangement of the usual types of signs and structures associated with railway tracks are dealt with in this section for general information.

TRACK SIGNS

Track signs are used for the purpose of indicating to railwaymen and all concerned needed information or notification in a simple, clear and enduring form; they are symbolic instructions and are placed where experience has shown they will be of most value.

Track signs of every description must be maintained in their proper position. They must not be permitted to be obstructed by the growth of trees and scrub on railway property, and every care must be taken to guard them against damage, especially by fire during burning off operations. No rubbish of any description should be permitted to accumulate about the signs and grass should be chipped to a safe distance from them.

MILE POSTS

Mile posts indicate the through mileage, and half-mile posts the half mileage between mile posts; they are placed on the 'down' side of the track in a position to be most easily seen from passing trains. The types of mile posts in use are shown in Fig. 1 (timber), and Fig. 2 (concrete).

GRADE BOARDS

Grade boards were at one time provided on certain lines to indicate the points of grade change. The practice has been discontinued for some years, but some grade boards are still in existence.

GANG POSTS

Gang posts indicate the extent of gang lengths; they are placed on the 'up' side of the track and originally showed the number of the gang and the letter 'G' on the post. In 1937 the letter 'G' was abolished and during 1943 the numbers were deleted so that the present standard post is plain. These three standards of gang posts are shown in Fig. 3.

WHISTLE POSTS

Whistle posts, shown in Figs. 4 & 5, are track signs placed facing the direction of traffic at the approach to cattle guarded level crossings, hand operated gates, and at other places specially approved by Head Office.

SPEED BOARDS

Speed boards, shown in Fig 6A, are placed on the left-hand side of the track in the direction of traffic at 10 feet from the nearest rail to indicate the allowable speed on curves of such radius that reduced speed is considered necessary. Arrangements are provided, where necessary, for illumination of speed boards for use by night.

The speed board shows the authorised speed and the pointed end indicates the direction of the curve. Where speed boards are provided between tracks, the short mounting is necessary, as shown in Fig. 6B.

FOOT CROSSING SIGNS

Notice-boards for foot crossings shown in Fig.7 are placed outside the clearances in a position to be plainly seen by pedestrians approaching the railway lines from either side.

TRESPASS BOARDS

Trespass Notice-boards, shown in Fig. 8, are placed at bridges of 150 feet length or over and at such other places as necessary to caution trespassers.

LEVEL CROSSING SIGNS

Level crossing signs are placed at every cattle guarded level crossing to indicate to road users the presence of railway lines across the roadway.

The types of level crossing signs in use are shown in Figs. 9, 10, 11A & 11B. They are placed outside the clearance in a position to be plainly seen from either side by approaching road traffic.

WIG WAG SIGN

The 'Wig Wag' is an electrically operated level crossing sign shown in Fig. 12. Its purpose is to indicate to road users the presence of railway lines across the roadway.

FLASHING LIGHT SIGN

The Flashing Light sign is an electrically operated level crossing sign shown in Fig. 13, its purpose being the same as the 'Wig Wag'.

Both the 'Wig Wag' and Flashing Light signs are automatically operated by the approach of a train, and in addition to displaying the visual signal a warning bell rings continuously while the train is approaching the crossing.

To control the electric current operating these signals, a section of the track is isolated by insulated joints; intermediate rails are bonded to form a continuous circuit and connected to a source of electric energy. When the wheels of a train enter the isolated section the electric current passes through the wheels and axles from one rail to the opposite rail thus completing the electric circuit.

The signal operates continuously during the passage of the train through the isolated section of track.

WARNING AND CAUTION SIGNALS

These are Way & Works Branch signals used to indicate reduced speed during repairs to bridges and culverts, relaying of track, or other works affecting the safety of any running line. The types of signals and their arrangement in relation to the track obstruction are shown in Fig. 14.

Warning and Caution boards are painted yellow on the face with letters in red, and the backs of the boards are painted green. The boards are for daylight signals, and lights for night-time are provided as shown in Fig. 15.

In special cases the boards and signals shown in Figs. 16, 17 & 18 are used.

The point at which normal speed may be resumed is marked by either the 'N' board, Fig. 16, or the Permanent Way signal Fig. 18.

The Speed Restriction board, Fig. 17, is so placed to indicate to the driver the speed at which his train is to traverse the point of work.

SERIES PARALLEL INDICATORS

These are installed on the left-hand side of the track relative to the direction of traffic to indicate to motormen where a change of power application is necessary.

Three types of boards are in use, as shown in Figs. 19, and 20, and denote full series, series parallel, and coasting conditions. Where practicable these indicators are fixed to masts of the overhead structures, but at other locations the indicators are erected on timber posts varying in height according to clearance requirements.

Three finger indicators were installed prior to 1928, but two finger indicators have been installed since this date.

INDICATOR BOARDS

Indicator boards are provided to convey instructions or define the position and purpose of equipment. Various examples of these boards are shown in Figs. 21-25.

VALVE BOARDS

The position and purpose of concealed valves is indicated on adjacent structures, or by indicator boards bearing letters and distances to indicate the position and type of appliance.

MC denotes Millcock. FP denotes Fire Plug. SV denotes Stop Valve. AV denotes Air Valve, etc.

The inscription $\frac{MC}{12}$ indicates a Millcock at a distance of 12 feet measured at right angles from the face of the indicator board.

ASH DUMP BOARDS

Indicator boards at ash dumps show the length of track prepared for dumping of ashes, and give instructions in regard to quenching live ashes.

At ash dumps the track is either laid with steel or concrete sleepers or the timber sleepers are protected by flat sheets of steel with a layer of sand between them and the sleepers.

PERMANENT MARKINGS

Permanent marking is necessary to establish the fixed position of track alignment, level and cant.

At the intersection of tangents the P. of I. is sometimes marked by a post having an auger hole in which the surveyors can fix a sighting rod when re-locating the alignment of track.

Levels are marked on structures or by posts bearing the inscription BM, meaning bench mark to which levels are referred.

Rail level standards, shown in Fig. 26, are placed on each side of the track and at both ends of overway bridges to indicate the minimum permissible overhead clearance, and the track must not be lifted above these levels.

At the centre of platforms the mileage is permanently marked by figures cut into the face of the platform coping showing the distance in miles, chains and links from Melbourne.

Mileage West of Spencer Street Station is measured from the alignment of the southerly side of Collins Street; mileage East of Flinders Street Station is measured from the centre of No.1 platform, Flinders Street Railway Station at 3 chains $32\frac{1}{2}$ links westerly of the centre line of De Graves Street.

The break of mileage between Spencer Street and Flinders Street Stations measured as above is 0 miles 61 chains 23 links.

Mileage on the St.Kilda and Port Melbourne lines is measured from the original site of the old Station clock tower 15 links westerly of the centre line of Elizabeth Street.

The centre of main tracks on curves is defined by centre pegs having a nail driven at the point from which the outer rail should be distant $2'7\frac{1}{2}"$. See 3.10.

STRUCTURES

Structures directly associated with the track must be protected against damage by fire, flood, etc., and the necessary repairs be effected in accordance with departmental instructions.

BUFFER STOPS

Buffer stops are structures erected at main line terminals and dead-end sidings to offer a reasonable resistance to rolling stock and bring the vehicles to rest at the end of the tracks.

The pile buffer stop shown in Fig. 27 is the standard in natural ground, and the sill buffer stop, Fig. 28, is the standard for embankments, soft ground, or rock.

Where buffing is heavy the buffer stop is backed with a mound of earth or stone to afford additional resistance. Sleeper bearers are placed under the sills behind the buffer stop to provide additional support where the foundations are bad.

CATTLE PITS

At open PCR crossings cattle pits are provided to prevent livestock from trespassing on railway property and endangering the safety of trains.

The pit is an underway clearance provided to effectively drain the area occupied by the cattle pit logs supporting the track. See Figs. 29 & 30.

Drainage is necessary to retard decay of the cattle pit logs.

Where pits are not required the surface grid, shown in Fig. 31, is used.

FENCES

Fences are provided where necessary to prevent livestock entering railway property. The boundary of railway property is generally indicated by means of fences.

The types of fences vary, but the present standard railway boundary fence is shown in Fig. 32, and complies with the Fencing Act as set out in Way & Works Instructions.

The straining lengths should not exceed 100 yards because the expansion in hot weather would so slacken the wires as to render them useless against the trespass of small stock.

If, on the other hand, the strain lengths are too short, there will be insufficient "give" in the wires and it will be impracticable to stretch and keep them "taut".

LEVEL CROSSINGS

Level crossings are locations where roadways cross the tracks at rail level.

PCR crossings are 'public carriage roadways' crossing the tracks, and private crossings are private roadways crossing the tracks.

At level crossings at main roads special construction is required to continue the roadway surface across the track and provide the necessary flangeways for railway traffic.

When tramtracks cross railway tracks, underway structures are sometimes provided to support the special crossing work required.

Gates, interlocked or hand operated, are provided to control traffic at certain busy crossings.

BRIDGES

Overway bridges are structures provided to maintain traffic thoroughfares over the tracks.

Underway bridges are structures provided to carry the tracks over roadways, waterways, and other tracks.

SUBWAYS

Subways are provided to maintain thoroughfares and facilities under the tracks.

FLOOD OPENINGS

Flood openings are underway structures provided to pass flood waters under the tracks at locations subject to flooding.

CULVERTS

Culverts are underway structures provided to carry water under the tracks. Box culverts are used in shallow embankments, but due to the difficulty of renewals, pipe culverts are used through deep embankments.

When brick arch or concrete culverts are used in shallow banks the culverts are kept sufficiently below the track to distribute the pressure and avoid damage to the structures .

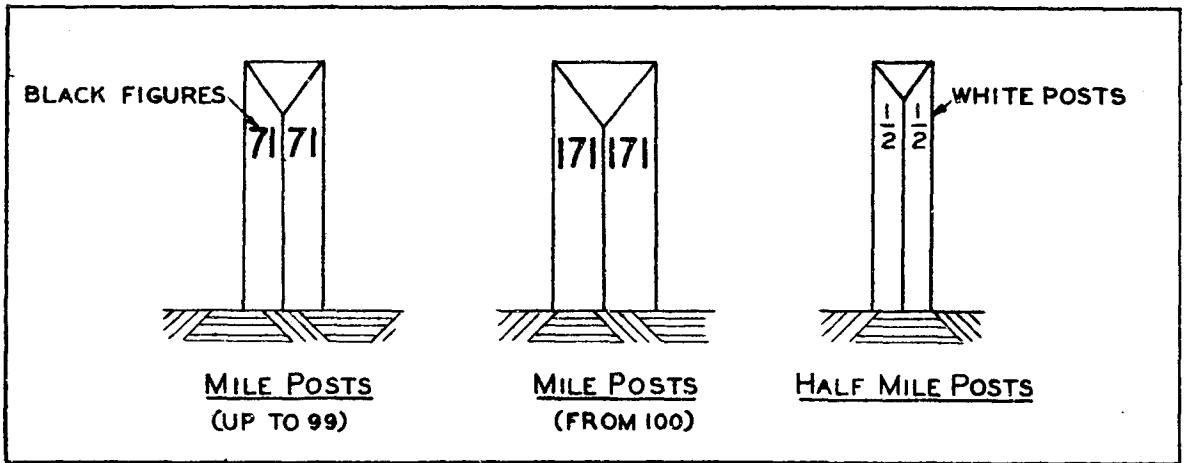

FIG. 1. ORIGINAL STANDARD MILE AND HALF MILE POSTS

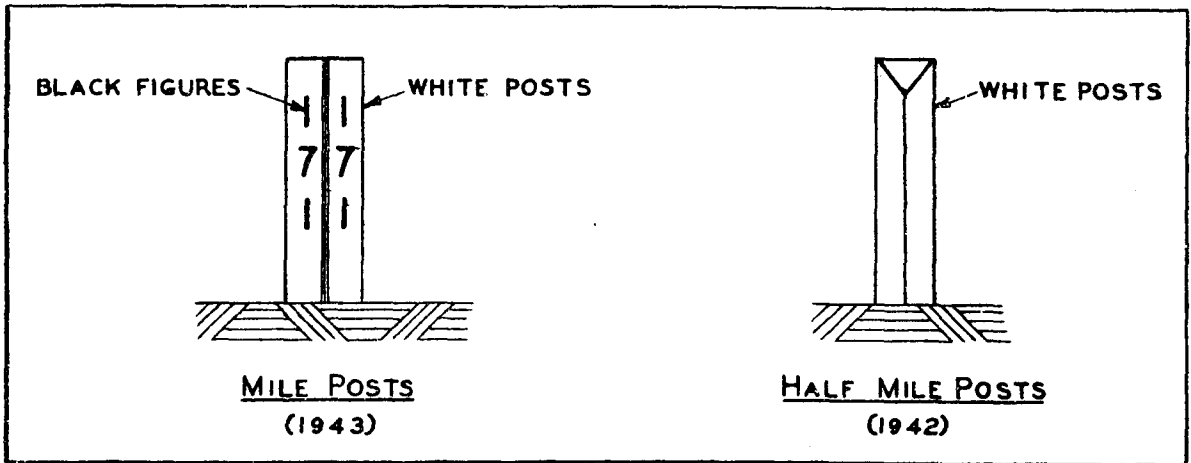

FIG. 2. PRESENT STANDARD MILE AND HALF MILE POSTS

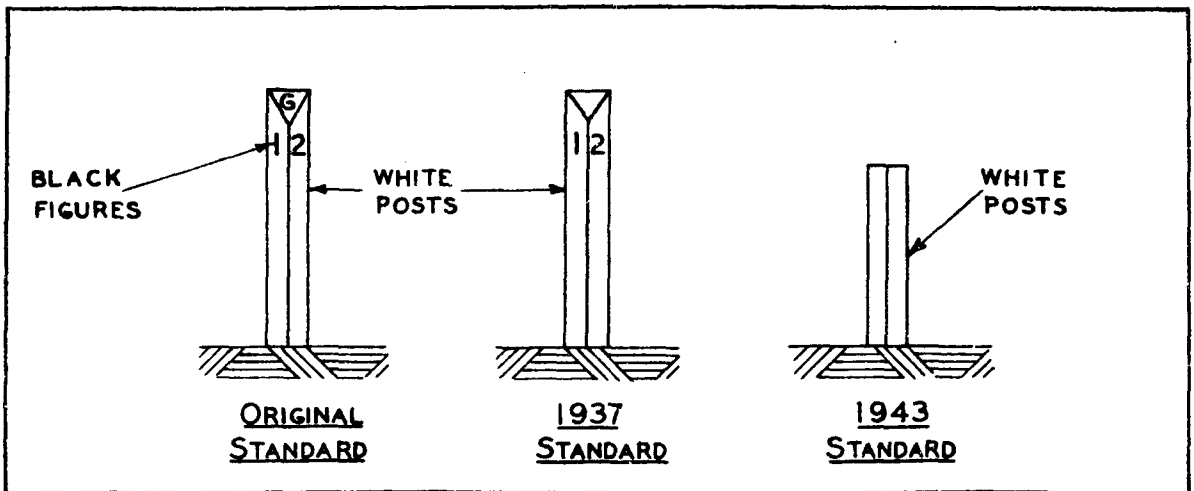
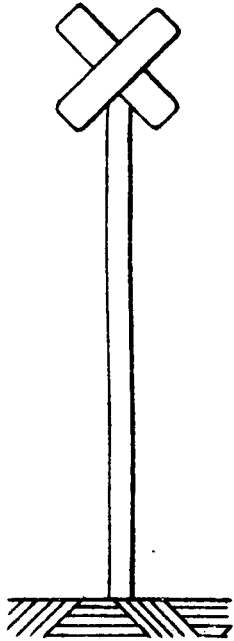
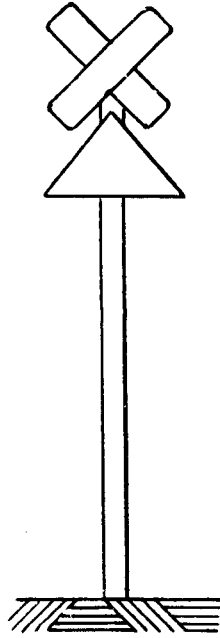

FIG. 3. GANG POSTS — VARIOUS STANDARDS



POST - WHITE
FRONT OF CROSS - WHITE
BACK OF CROSS - BLACK

FIG. 4. STANDARD
WHISTLE POST.



POST - WHITE
FRONT OF CROSS - WHITE
AND TRIANGLE - WHITE
BACK OF CROSS - BLACK
AND TRIANGLE - BLACK

FIG. 5. WHISTLE POST
IN CONNECTION WITH
HAND OPERATED GATES

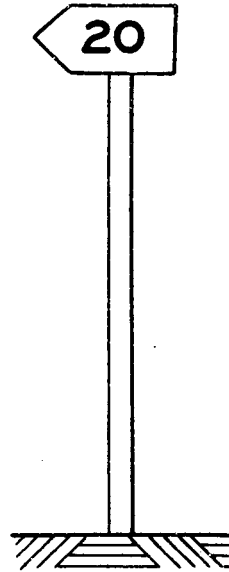

FIG. 6.A. OUTSIDE TRACKS

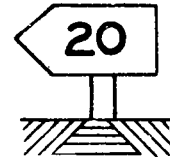
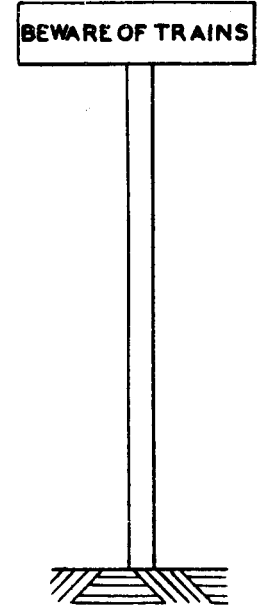

FIG. 6.B. BETWEEN TRACKS

POST AND BOARD - WHITE
NUMERALS - BLACK

FIGS. 6A. & 6B.
SPEED BOARDS



POST AND BOARD - WHITE
LETTERING - BLACK

FIG. 7. FOOT CROSSING
SIGN

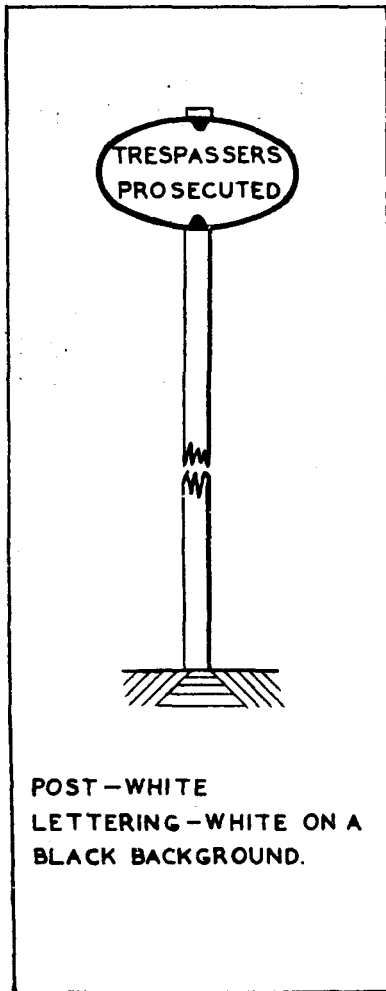

FIG. 8. TRESPASS BOARD

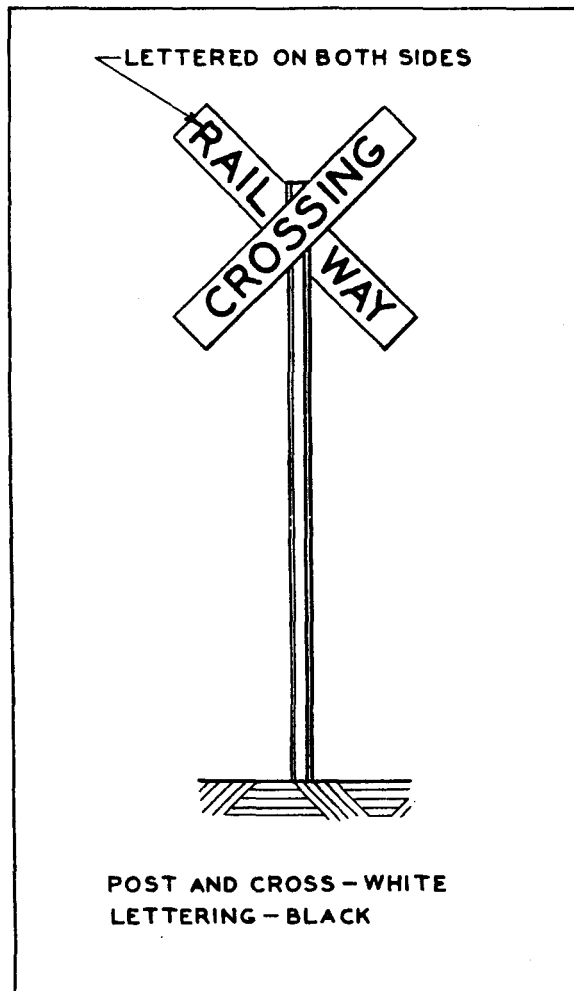

FIG. 9. STANDARD LEVEL
CROSSING SIGN

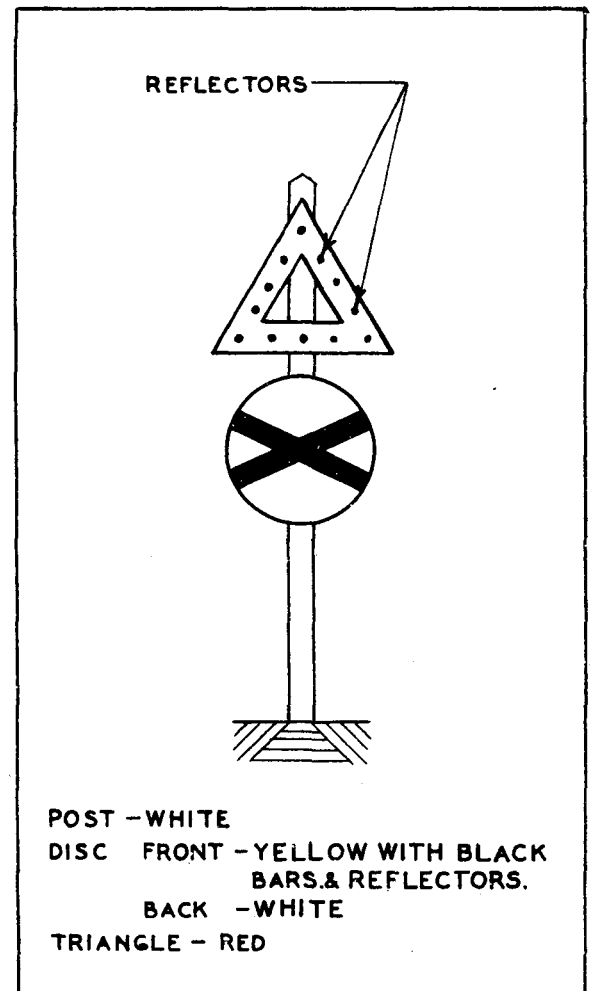

FIG. 10. ROAD APPROACH SIGN
FOR LEVEL CROSSINGS

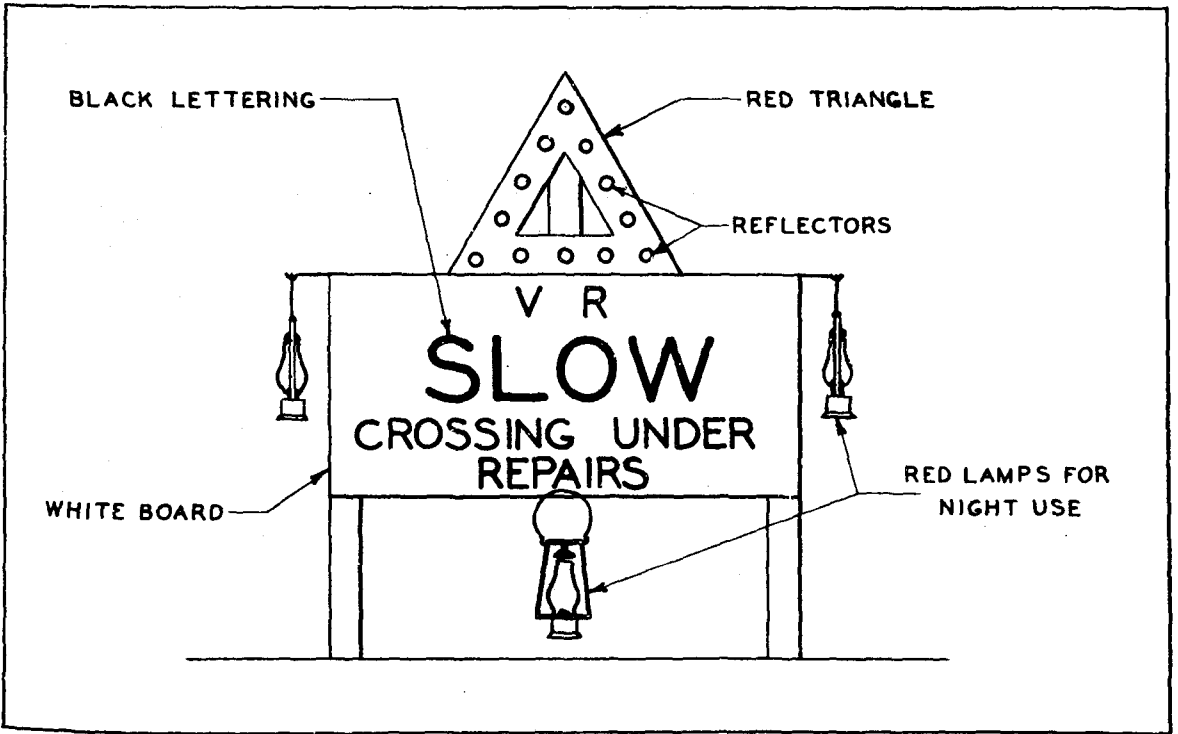

FIG. 11.A. LEVEL CROSSING REPAIR SIGN

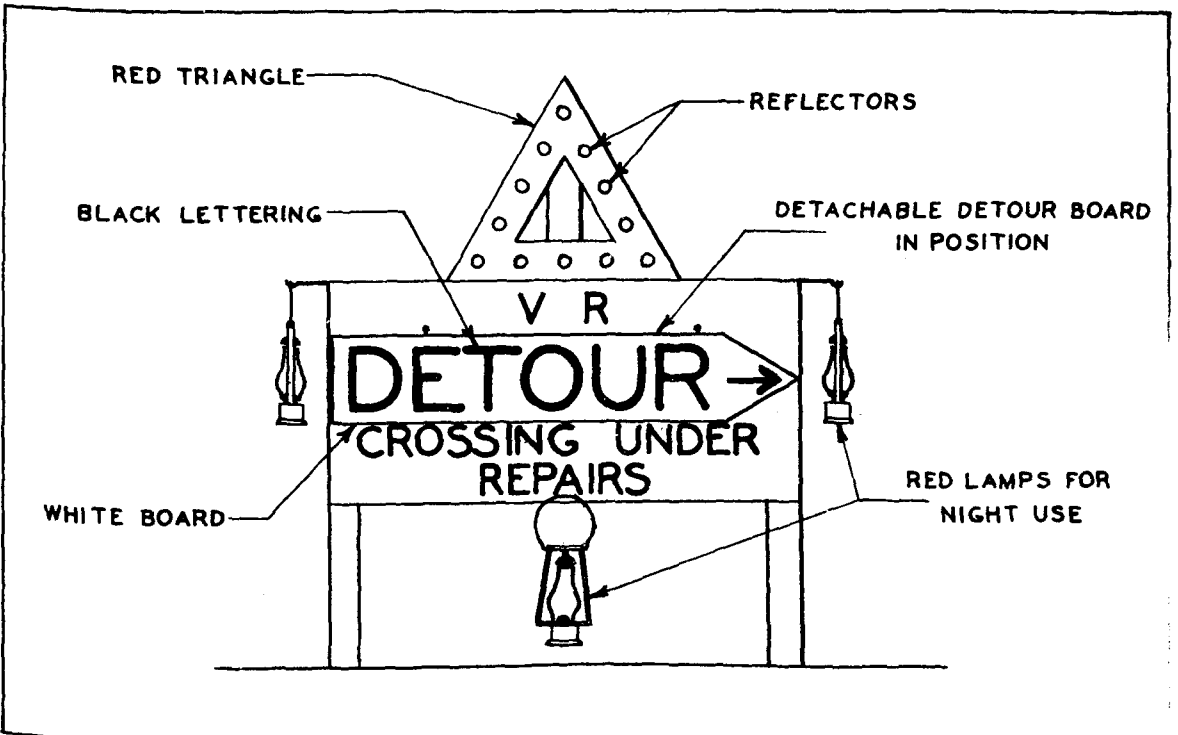

FIG. 11.B. LEVEL CROSSING REPAIR SIGN - DETOUR BOARD

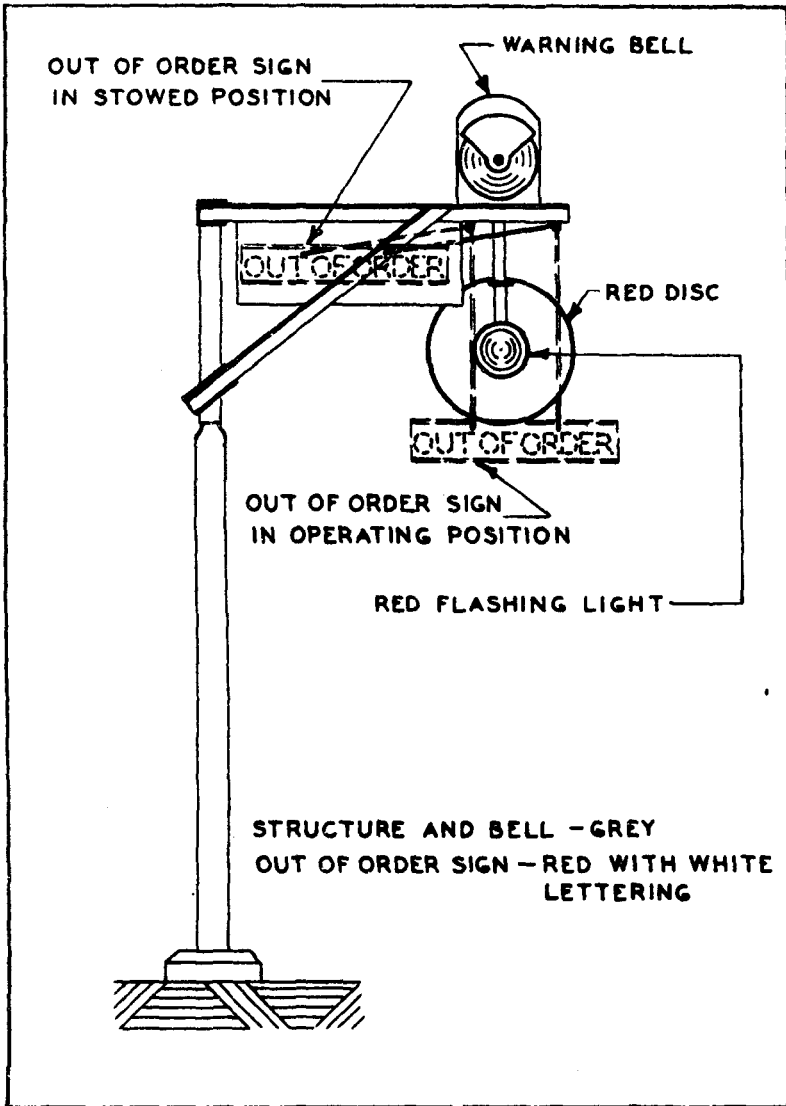

FIG.12. THE WIG WAG - LEVEL CROSSING SIGN

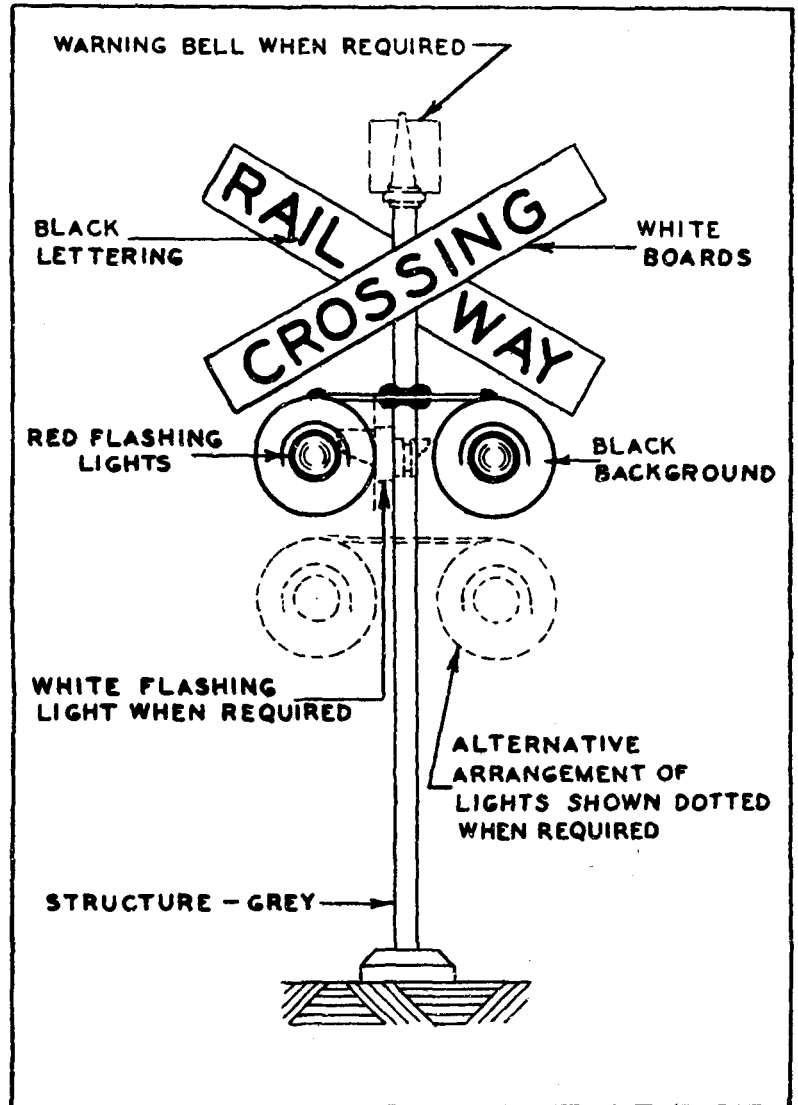
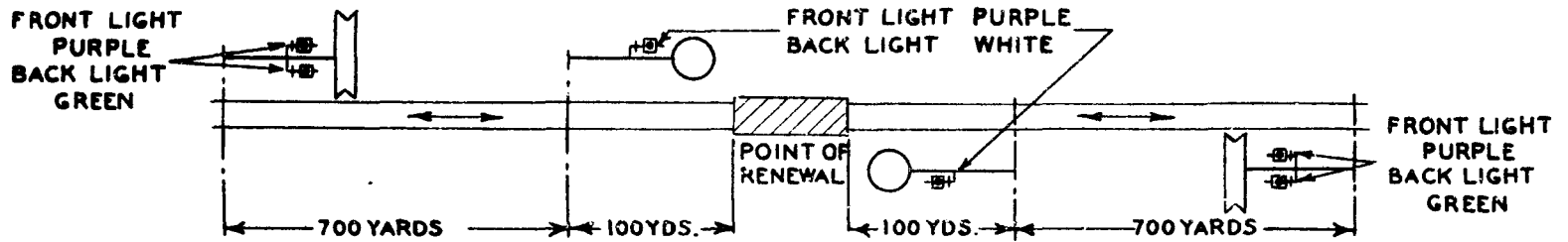
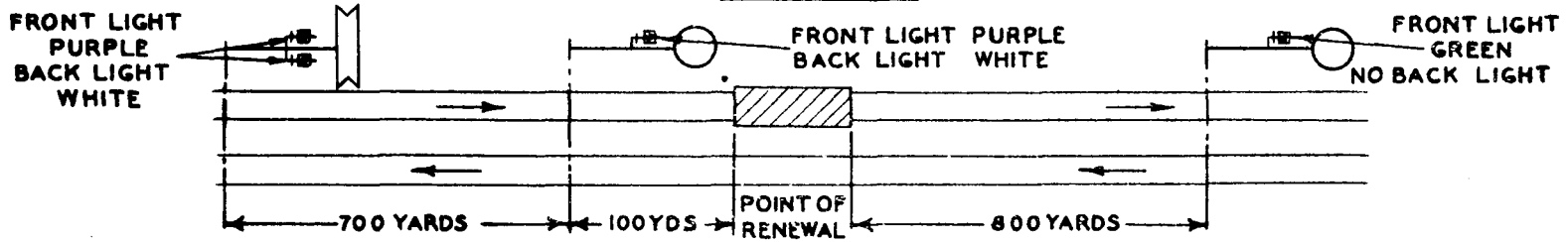

FIG.13. THE FLASHING LIGHT - LEVEL CROSSING SIGN

SINGLE LINE



DOUBLE LINE (ONE LINE ONLY AFFECTED)



DOUBLE LINE (BOTH LINES AFFECTED)

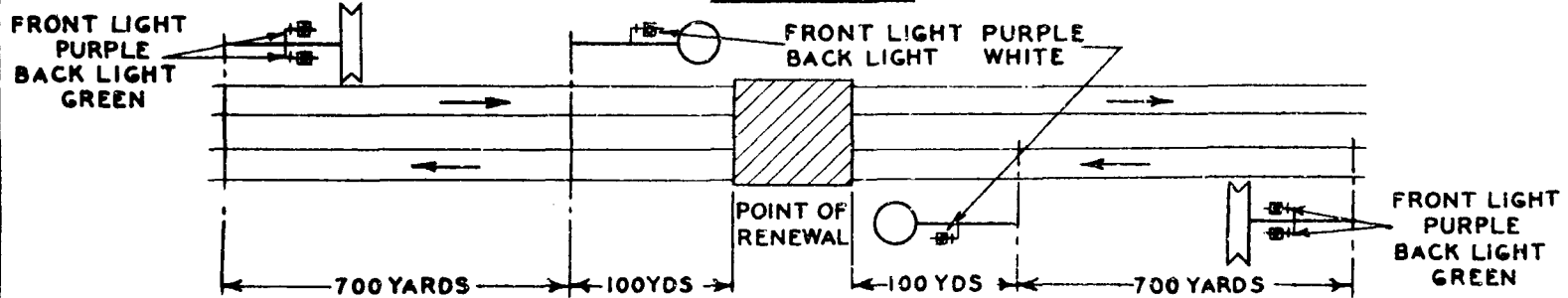

NOTE:- FOR DETAILS OF SIGNALS SEE FIGS. 15. 16. 17. AND 18.

FIG. 14. ARRANGEMENT OF WARNING AND CAUTION SIGNALS

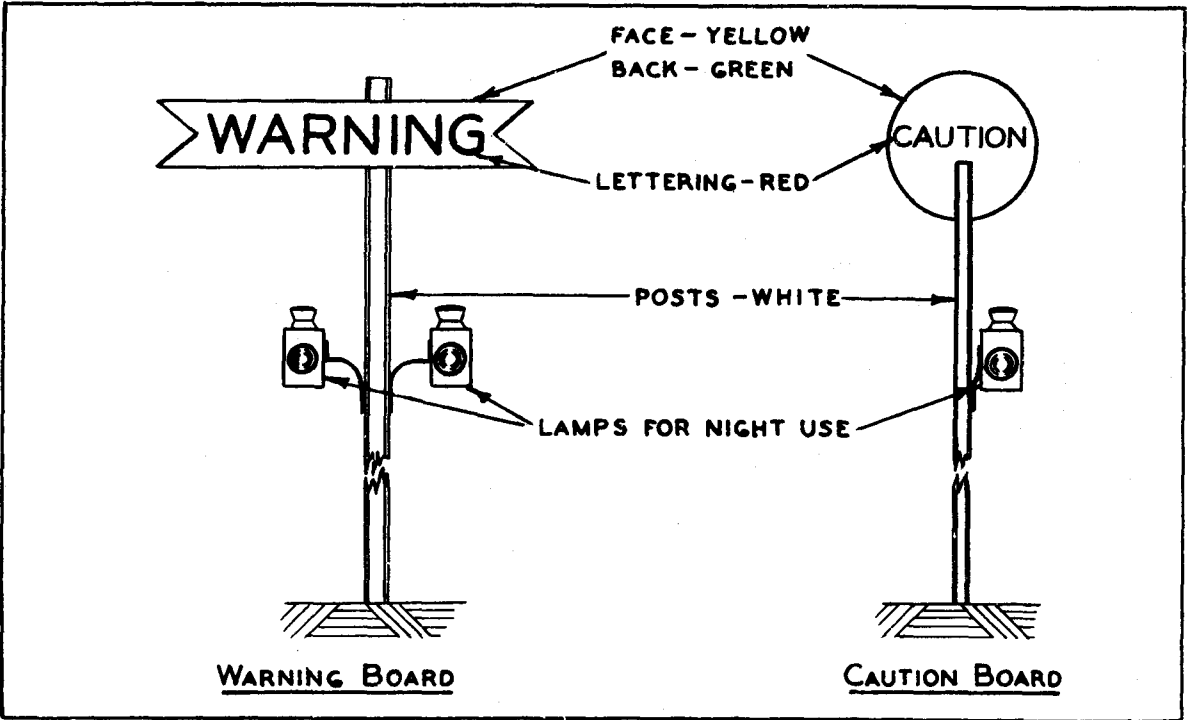

FIG.15. WARNING AND CAUTION BOARDS

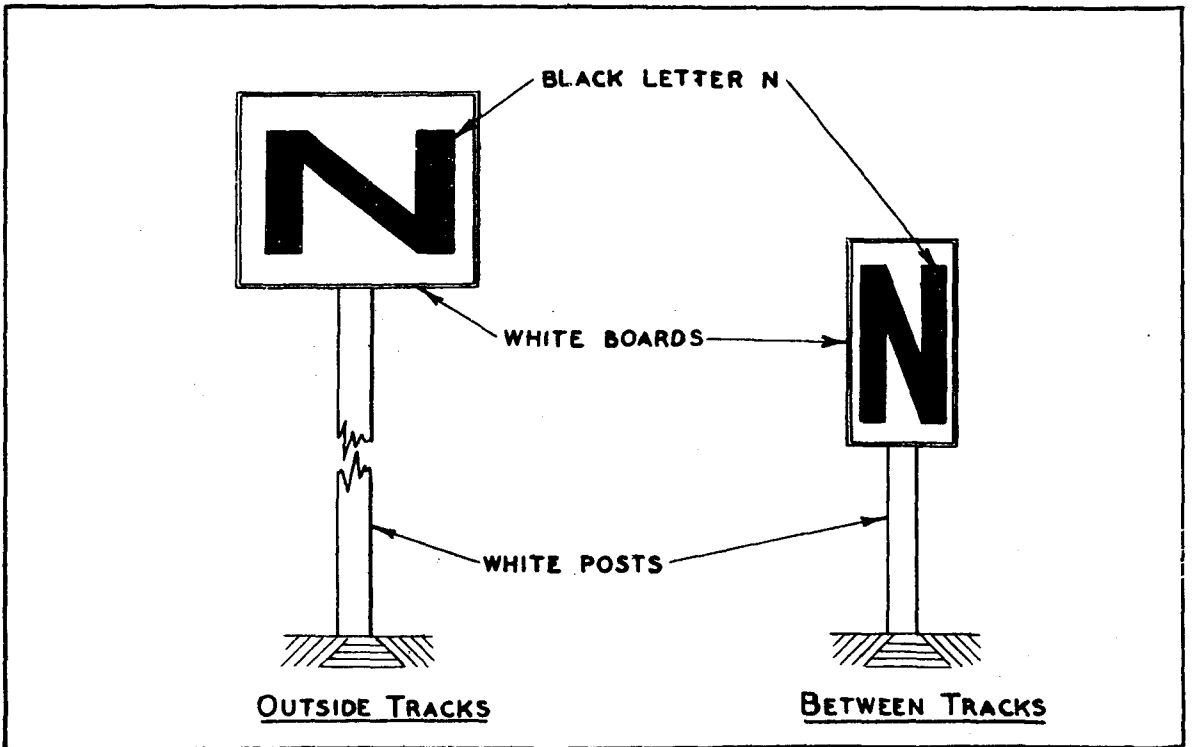

FIG.16. NORMAL RUNNING OR N BOARDS

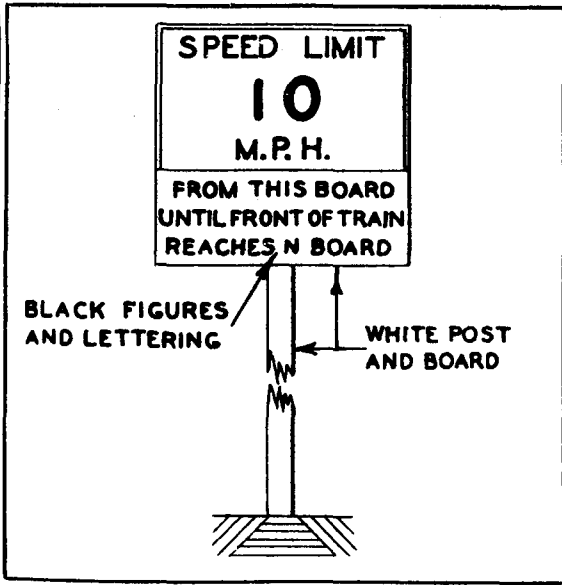

FIG.17. TYPICAL SPEED RESTRICTION BOARD

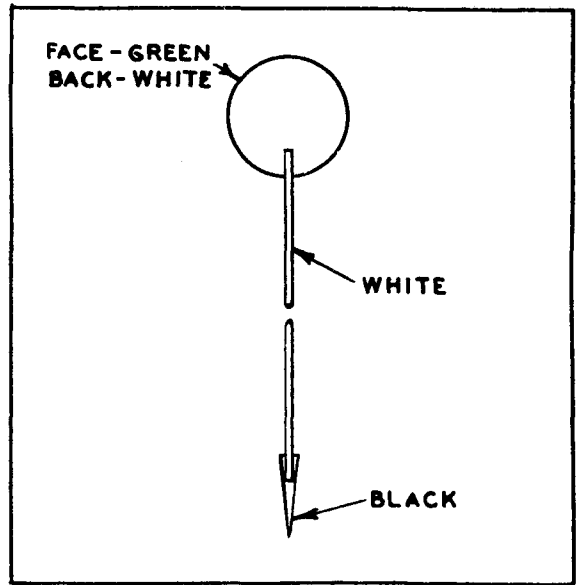

FIG.18. PERMANENT WAY SIGNAL

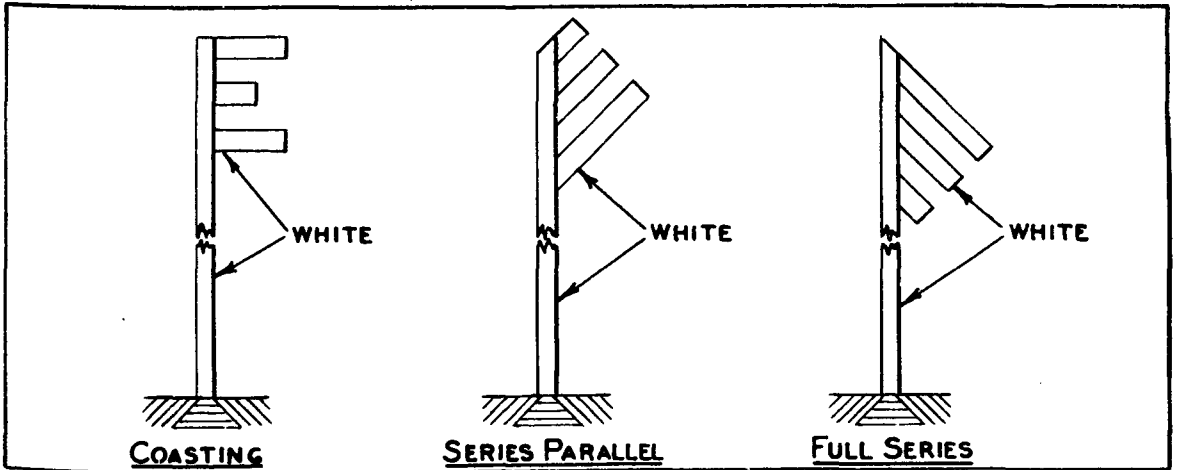

FIG.19. SERIES PARALLEL INDICATORS ORIGINAL STANDARD

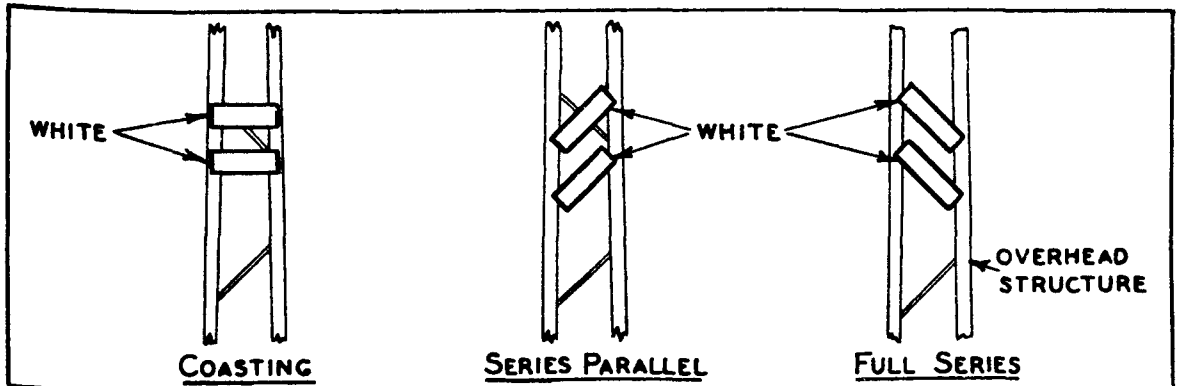

FIG.20. SERIES PARALLEL INDICATORS. 1928 STANDARD

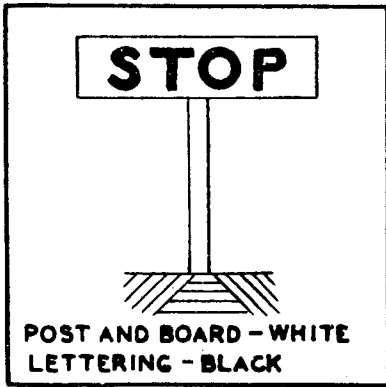

FIG. 21. STOP BOARD

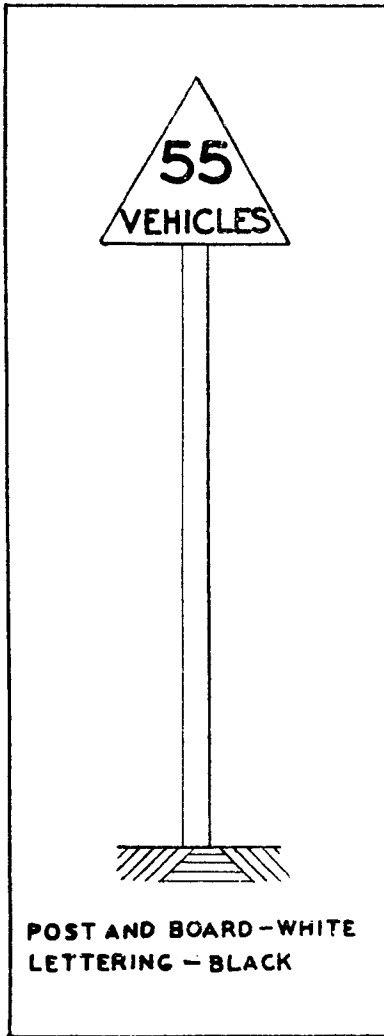

FIG. 23. VEHICLES BOARD

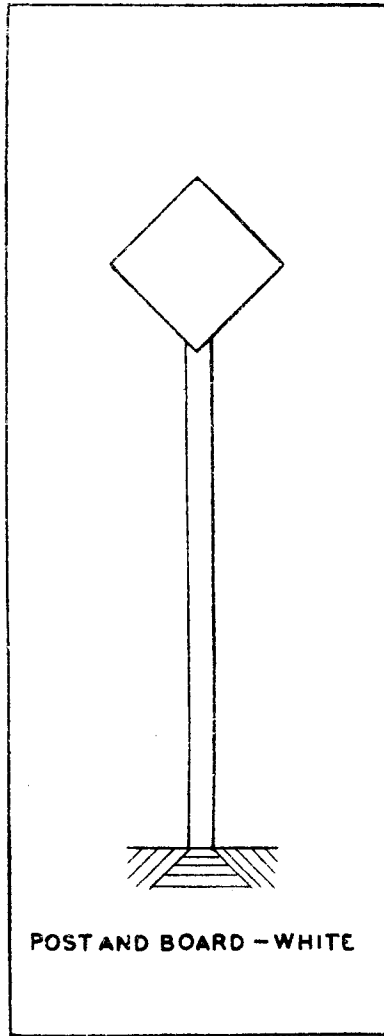

FIG. 24. DIVIDE LOAD BOARD

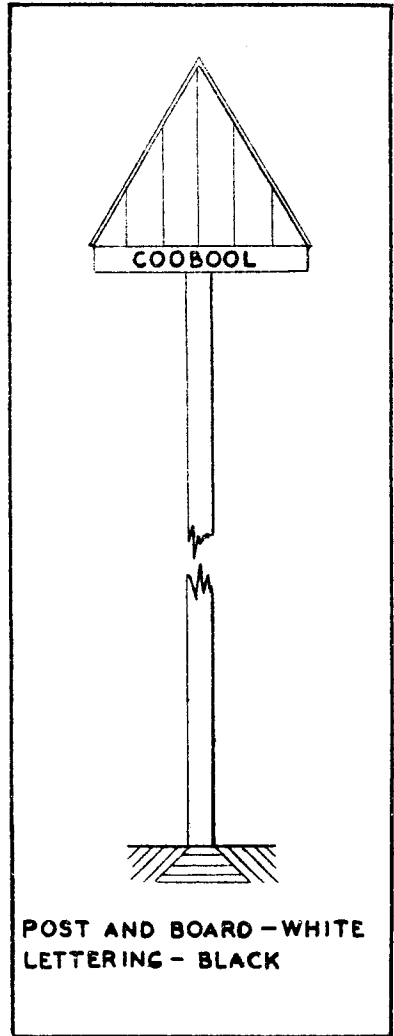

FIG. 25. LOCATION BOARD

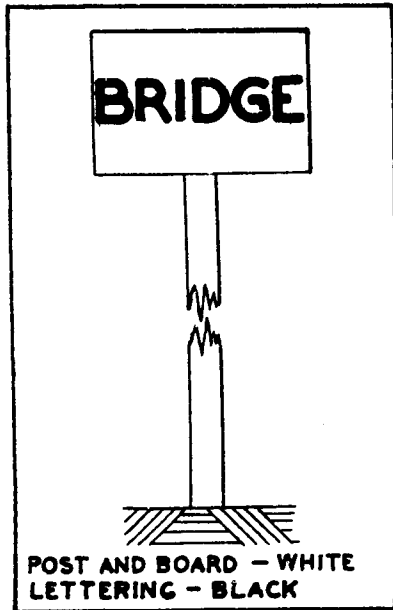

FIG. 22. BRIDGE BOARD

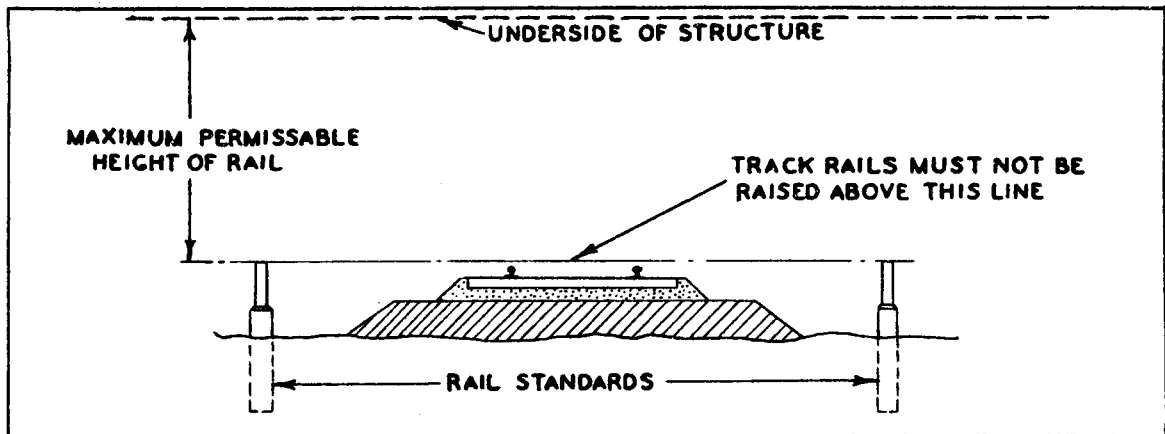

FIG.26. RAIL LEVEL STANDARDS

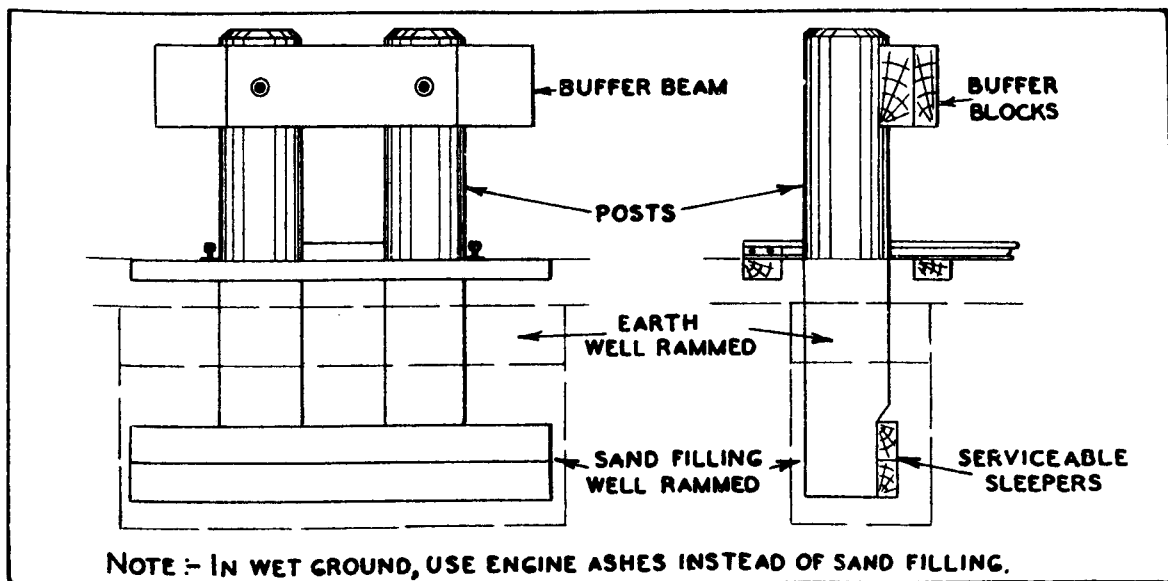

FIG.27. PILE BUFFER STOP (NATURAL GROUND)

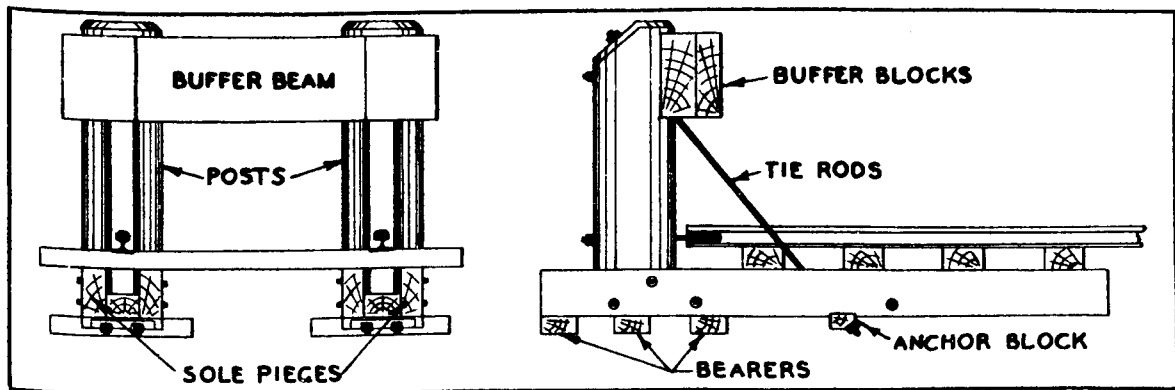

FIG.28. SILL BUFFER STOP (EMBANKMENTS, SOFT GROUND OR ROCK)

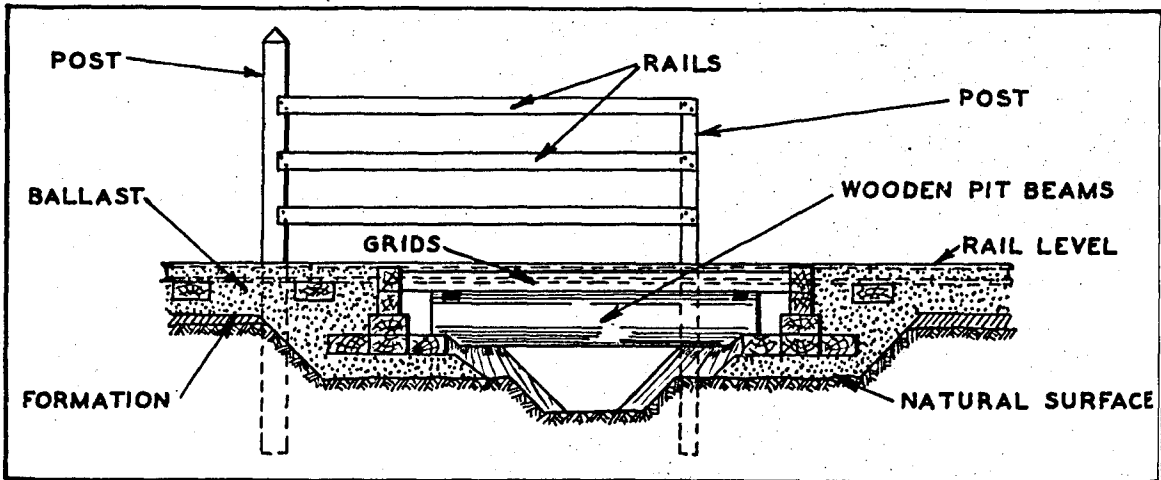

FIG. 29. CATTLE PIT — WOODEN BEAMS

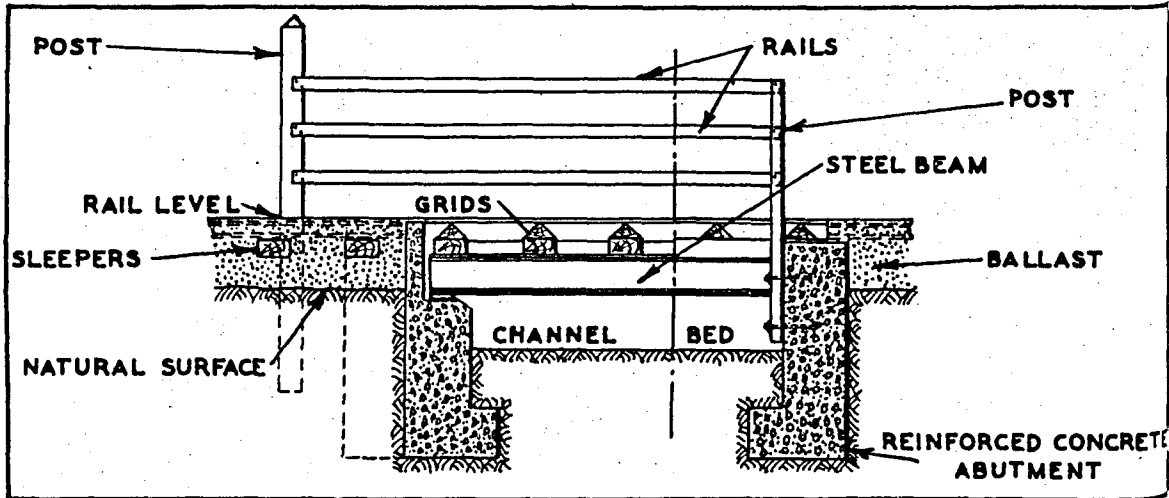

FIG. 30. CATTLE PIT — STEEL BEAMS

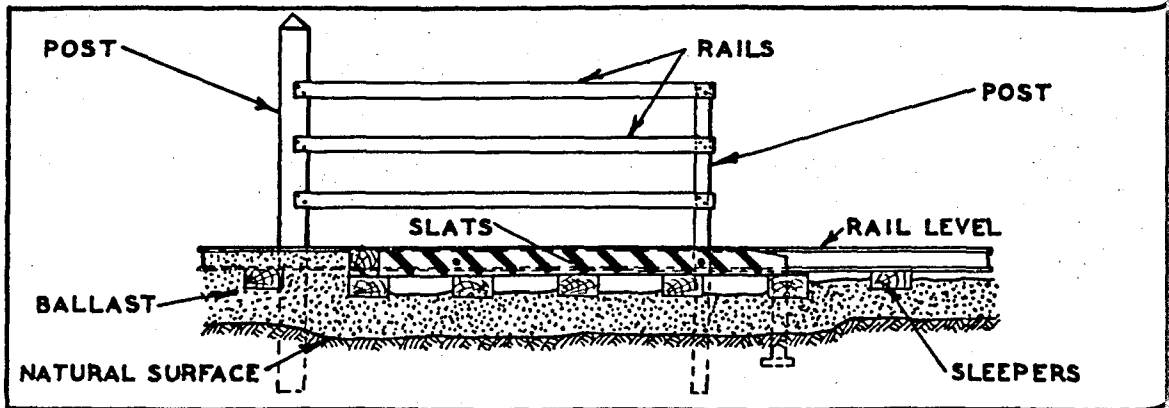
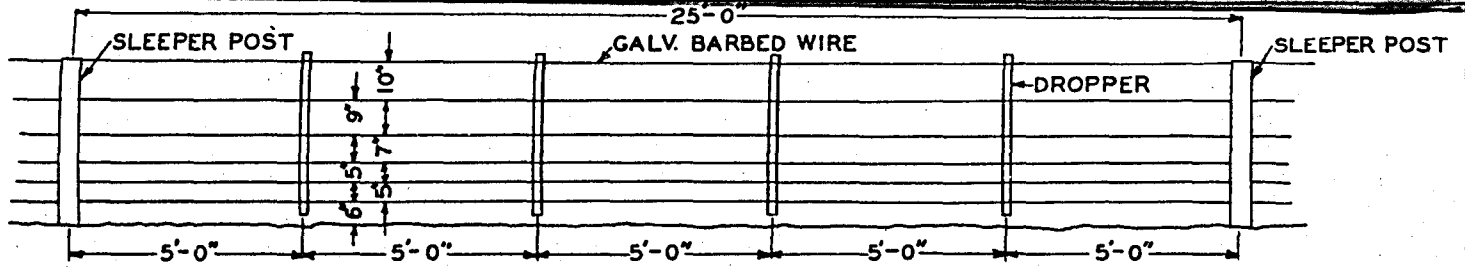
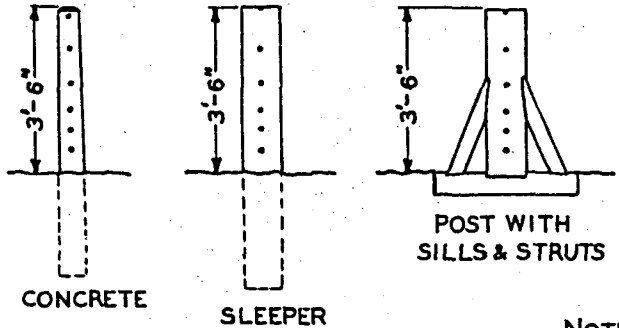

FIG. 31. SURFACE GRID



ELEVATION OF ONE PANEL



CROSS SECTIONS OF POSTS

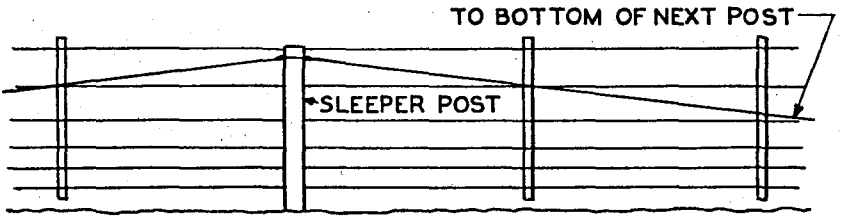

STRAINING POST

NOTE: - DROPPERS TO BE SECURED TO RAILWAY SIDE OF WIRES

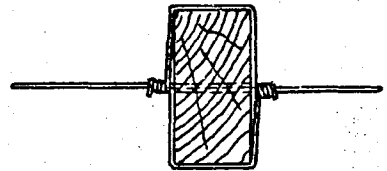

FASTENING OFF OF WIRES

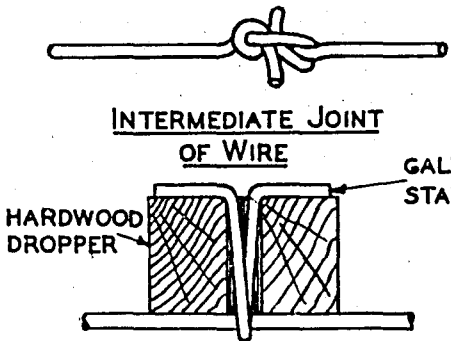

DROPPER FASTENINGS

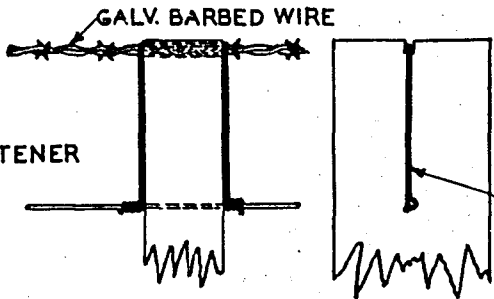

FASTENING BARBED WIRE TO POSTS (EVERY 8TH. POST)

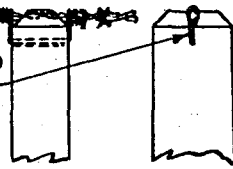

CONCRETE

73

4.19

FIG. 32. THE PRESENT STANDARD RAILWAY BOUNDARY FENCE

5. EARTHWORKS.

GENERAL

The EARTHWORKS necessary in railway construction comprise the excavation of CUTTINGS and filling of EMBANKMENTS to prepare the FORMATION on which the TRACK and TRACKWORK is laid, and the provision of the necessary DRAINS for diversion and disposal of surface water from the vicinity of the permanent way.

LONGITUDINAL SECTION

Grading of the longitudinal section of the track is most economically arranged when the excavation from adjacent cuttings balances with the filling required in the embankments as shown in Fig. 1.

In flat country the spoil necessary for constructing surface formation is usually obtained from the surface drains and side cuttings.

CUTTINGS

Cuttings are excavated to provide for the finished formation widths necessary for the location and grading of tracks and trackwork layouts and the cess drains required for effective drainage.

The faces of the cuttings are sloped according to the nature of the material through which the cuttings are excavated. For average conditions the standard slope is 1 to 1, but in firm material the slope or batter is decreased and in rock may be almost vertical depending upon the state of preservation of the rock and the dip of the strata, as shown in Figs. 2, 3, & 4.

In bad ground such as wet drift sand or very soft clay, the slope is made much flatter, or retaining walls are provided, as in Fig. 5. Retaining walls are also necessary when the width of railway property is insufficient to run out the necessary slope for cuttings and embankments.

The angles at which the slopes are trimmed are usually expressed at a rate of slope or rise of 1 foot in a horizontal distance of so many feet.

The inclination of 'batters' is expressed in the opposite sense i.e., as a rise of so many feet in a horizontal distance of 1 foot. See Fig. 6.

When the nature of the material excavated varies as with loose material overlaying sound rock, the slope of the cutting may change, as in Fig. 7, or a berm may be established at rock level to prevent the loose material from spilling down the face of the cutting and obstructing the cess drains; this type of construction is shown in Fig. 8.

Under the action of the weather the slopes of cuttings are eroded and detritus is deposited in the cess drains below thereby causing blockages and interfering with drainage.

As masses of material, loosened by the effects of the weather, may fall and obstruct the track, it is necessary to regularly clean down the face of cuttings which are subject to surface erosion.

Erosion of the slopes maybe reduced by sodding or planting with grass or other suitable vegetation, but the growth of shrubs and trees should not be permitted in rock cuttings as the roots tend to dislodge the material and the branches may obstruct the view of the track for train crews.

Extensive slips of the face of cuttings require special treatment as described in 18.11.

In sand cuttings, fretting of the slopes may be considerable under the action of wind and under these circumstances it is sometimes preferable to cast the sand back on the slopes rather than continue to remove it from the base of the cutting to a point of disposal. Wind chutes, arranged as in Fig. 9, are in use in dry sandy districts, and by deflecting the direction of the wind, they cause loose sand to be blown clear of the tracks.

TUNNELS

When the depth and quantity of excavation involved in excavating a cutting is excessive and the nature of the country is suitable, tunnels are driven to pass the tracks underground. As the space through tunnels is necessarily restricted, due to the cost of construction, it follows that every care must be taken to properly maintain alignment, grade and surface of the tracks, otherwise the clearance may be fouled.

Seepage of water into the tunnel and the restricted space available for providing drainage further complicate the work of track maintenance. It is therefore of the utmost importance that the drains provided be kept in the best possible condition to effectively drain the formation.

The surface drains above the tunnels should be kept clear and to grade so that pockets of water will not collect and subsequently percolate into the tunnels. See 6.01 & 6.04.

For the protection of men working in tunnels, refuges are provided in the side walls when the length of tunnel is considerable, or in shorter tunnels where traffic is frequent.

EMBANKMENTS

Embankments are filled and formed to provide for the finished formation widths necessary for the location and grading of tracks and trackwork layouts.

Where the alignment of the track crosses low-lying ground embankments are usually constructed to elevate the track above flood level, and in grade separation work, where the track is elevated, to eliminate level crossings at public roadways.

The material for forming and filling embankments is generally obtained from the adjacent cuttings and the excess requirements from side cuttings.

Loose filling is subject to shrinkage or subsidence under pressure. The subsidence of embankments composed of rocks, when properly packed, is comparatively small. Sand and gravel lose little in bulk under consolidation, but clay, loam and surface soil shrink appreciably.

An allowance of 1 inch per foot of vertical height is usually made to allow for subsidence in embankments built with clay or loam deposited by drays or skid scoops.

The manner of constructing embankments has a considerable effect on their subsequent subsidence and stability.

On steep sidelong ground of a slippery nature the seat of the embankment should be benched, as in Fig. 10, to reduce the possibility of the embankment sliding bodily on its base.

When the formation is partly in cutting and partly on embankment, the dip of the strata and its state of preservation should be carefully studied before spilling the embankment material. See Fig. 11.

Across low-lying ground of a boggy nature it may be necessary to trench the embankment seat and provide cross drains to permanently drain the area. Drains provided for this purpose are graded to side drains and if soakage water only is to be dealt with rubble drains may suffice, but if surface water is also to be disposed of pipe drains are necessary, otherwise scouring may occur under the embankment seat. See 6.03.

Embankments should generally be constructed in horizontal layers of from 1 to 2 feet thickness, each layer being consolidated by the passage of horse teams, tractors, or rollers if necessary.

The class of material being deposited and the weather conditions have a considerable bearing on the subsequent subsidence and the stability of the embankment. Surface soil loosely deposited in dry weather requires a considerable time for consolidation, but if well saturated by rains during the progress of the work, the subsequent shrinkage would be considerably lessened.

Permeable material should be spread in layers sloping inwards, as by this construction the tendency of the embankment to slip is reduced.

Impermeable materials which retain water should be spread with the layers sloping outwards, otherwise water will collect in the gullets in the new earthwork and may be responsible for local slips or soft spots in the formation.

When the spoil available for construction of the embankment is of a variable nature the better materials should, if possible, be tipped at the base and top of the work thus providing a good foundation on which to rest the embankment and good drainage of the surface formation.

The usual angle at which the slopes of embankments are spilled and trimmed is $1\frac{1}{2}$ to 1, but this rate of slope depends upon the angle of repose of the materials available and the effects of the weather on the class of material.

Clods of earth should be broken up at the site of excavation as in the course of spilling the spoil, unbroken clods form voids which, under service conditions, will later cause trouble by subsidence.

Widening formation on narrow embankments of a hard and slippery nature necessitates benching of the slopes to support the added material, otherwise there is a danger of the added material slipping when first saturated by heavy rain. See Fig. 12. Benching is not required when the slopes are of a loose nature as the new material will interlock and bind with that of the embankment.

Embankments serving the dual purpose of carrying railway track and impounding water require to be specially constructed either of wholly impermeable material or with a waterproof face of impermeable material.

An example of this type of construction is shown in Fig. 13, and the importance of avoiding scour or removing material from the upstream face of embankments of this nature should be apparent.

RESERVOIR EMBANKMENTS

Reservoir embankments which do not carry railway track are spilled and formed according to their purpose and a typical earthen embankment for impounding water is shown in Fig. 14.

The cut off wall or core wall in the embankment should be of the best available clay, well broken and carefully consolidated in position as a puddle clay. Sufficient water should be used to thoroughly puddle the clay, and as the wall is built up in layers the surface of each layer should be broken up to receive the next layer of clay to ensure complete bonding of the material.

Every care should be taken to avoid the ingress of other materials to the clay puddle wall as such materials, breaking the continuity of the core wall, can be the cause of water penetrating the embankment and causing a wash-out.

BORROW PITS

On plain country where the track is carried over a valley or depression at a distance from any cutting, it may be necessary to obtain spoil for an embankment from borrow pits.

Borrow pits should be taken out uniformly over a regular area and the side slopes trimmed to a slope of 1 to 1 or otherwise, according to the nature of the country. Adequate provision should be made for the drainage of borrow pits so that water will not collect to form a nuisance or endanger the permanent way.

SIDE CUTTINGS

To form the formation on plain country it is frequently necessary to supplement the spoil excavated from the surface drains by spoil obtained from additional side cuttings.

All side cuttings should be taken out neatly to alignment with the side slopes trimmed to the angle of repose for the type of material, usually at 1 to 1. Outlet drains should be provided to effectively drain the cuts and attention should be regularly given to clearing the drains and to preventing scour.

The floor of all side cuttings should be graded away from the embankments with a uniform fall following the natural slope of the country towards the waterways and flood openings provided.

Side cuttings are avoided in locations such as station grounds or adjacent to public roadways etc., where there is a prospect of future extensions or alterations to roadways.

The inside edge of side cuttings should be located not closer than 6'0" from the toe of embankments and the boundary fence.

EXCAVATION

The methods of excavation depend on the class of country and the equipment available.

Shallow excavations are usually taken out by the aid of ploughs and skid scoops and the slopes trimmed with picks and shovels. Deeper excavations in firmer material may be loosened by power operated rippers and the spoil be removed and deposited where required or run to tip with wheeled scoops.

Deep excavations of a boggy nature are more readily carried out by the aid of drag line excavators. Deep excavations in firm ground may be taken out in a face by the use of power operated shovels. Excavations in rock, reef and hard country necessitate the use of explosives to loosen and break up the material.

FORMING AND GRADING

Bull dozers, skimmers and graders may be used where the amount of work permits of their economical use or where the urgency of the work justifies bringing the equipment to the site. Skid scoops, wheeled scoops, and drays are used on smaller jobs.

Side tipping trucks or muck dobbins are suitable where railed tracks can be provided.

VOLUME OF LOOSE SPOIL

The volume of loosened material greatly exceeds the volume prior to excavation and conversely a larger volume of loose material is required for filling subjected to consolidation. As spoil is shifted in a loosened condition provision must be made for moving a volume in excess of the excavation or filling of the work.

Clean sand and gravel when first loosened	swell about	15%
Loam, loamy sands and gravels		20%
Dense clay and dense mixtures of gravel and clay		35%
Very dense clays and rock		50%

Shrinkage of embankments constructed by scoops varies with the material and the age of the embankment. After three years settlement the following reduction in volume may be expected : -

In loose vegetable soil	about	12	to	16%.
" loamy soil	"	10	to	14%.
" clay	"	10	to	12%.
" gravel and sand mixed	"	8	to	11%.
" gravel	"	8	to	9%.

SLOPES

Ordinary earth cuttings will stand with slopes of 1 to 1 but if the slope is a long one gathering a quantity of water, a slope of $1\frac{1}{2}$ to 1 is preferable.

Gravel slopes generally require to be $1\frac{1}{2}$ to 1 and sand 2 to 1 if planted with a binding grass or otherwise protected from erosion by surface water.

Solid clay which is naturally dry is safe at 1 to 1, but if greasy, clay may not be safe at less than 5 to 1.

Many sandstones and limestones stand better when nearly vertical because they are then less exposed to the action of erosion from surface water.

TRANSPORT OF SPOIL

Methods of transporting and dumping spoil depend upon local conditions and equipment available.

BARROW AND PLANK

Barrow loads of about $1/14$ cubic yard measured in the solid before loosening can be wheeled up fairly steep grades on good planks. The lead or distance travelled with the loaded barrow should not exceed 100 feet for economy.

About 9 cubic yards of earth may be loaded, wheeled and dumped at 50 feet from the excavation per man per day of 8 working hours.

DRAYS

A single horse tip dray under favourable conditions will handle $3/4$ cubic yard per load measured in the solid, but over loose ground only $1/2$ cubic yard, and on steep broken grades $1/3$ cubic yard may be the maximum.

The rate of hauling is approximately 200 feet per minute and time of loading and dumping about 4 minutes. With a lead of 500 feet the number of round trips per 8 working hour day may be taken at 50.

SKID SCOOPS

The capacity of the skid scoop in operation depends upon the class of spoil and the grades up which the scoop is operated. A full scoop can be taken up a 3 to 1 slope but only a partly filled scoop can be taken up a 2 to 1 slope.

With a lead of 75 feet the distance travelled each trip will not be much less than 200 feet which can be covered in about 1 minute. If the scoop load be $\frac{1}{6}$ cubic yard the spoil removed will be about 60 cubic yards per 8 working hour day.

WHEELED SCOOPS

Wheeled scoops are obtainable in different sizes from 9 to 16 cubic feet capacity for horse work, but larger sizes are in use with power units. The average capacity of earth measured in place before loosening is about $\frac{3}{5}$ ths of the cubic capacity of the scoop. These scoops are suitable for much longer leads than skid scoops and are more economical under these conditions.

To fill the scoop it is usually necessary to use a snatch team in the excavation, and in long leads it may be of advantage to top up the load by shovelling in additional spoil after filling as far as possible in the usual way.

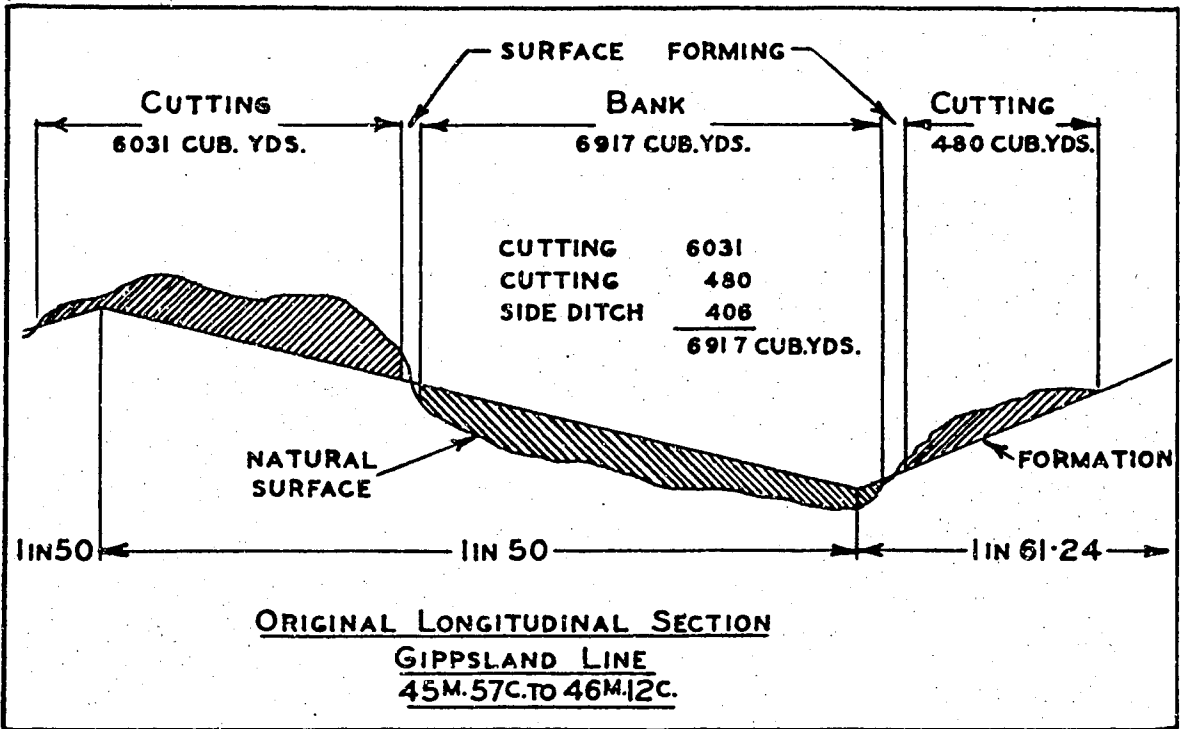

FIG. 1. BALANCING OF EXCAVATION WITH FILLING REQUIRED.

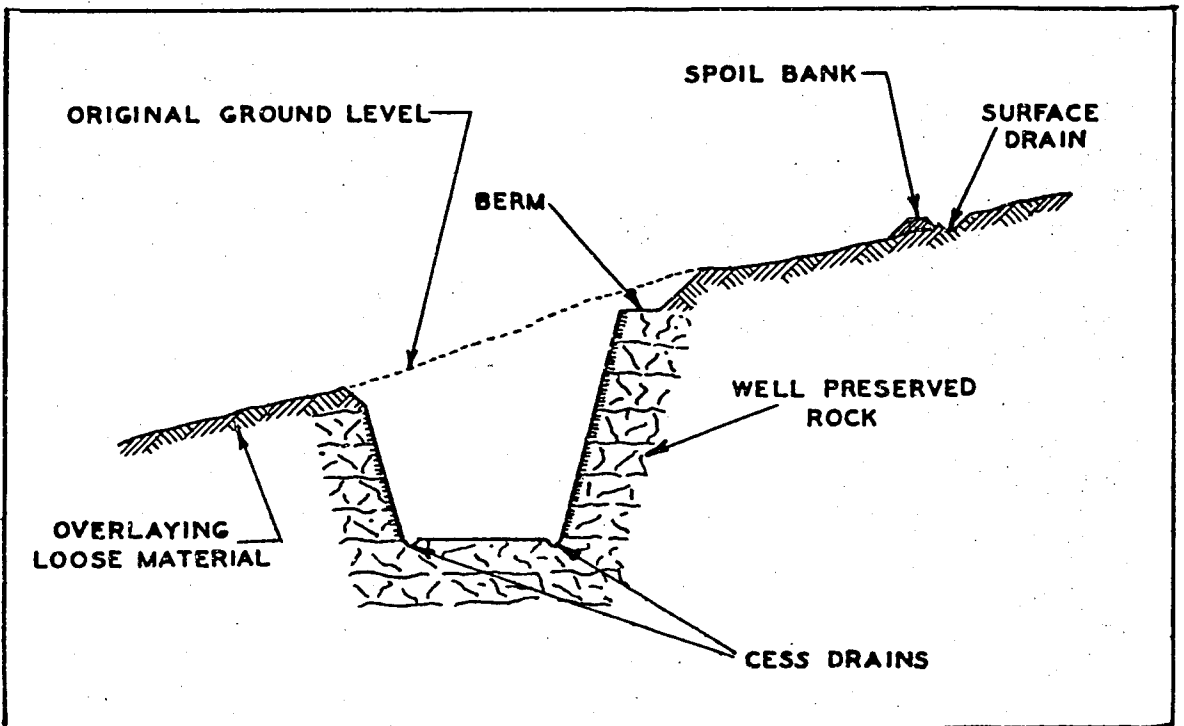

FIG. 2. CUTTING IN WELL PRESERVED ROCK

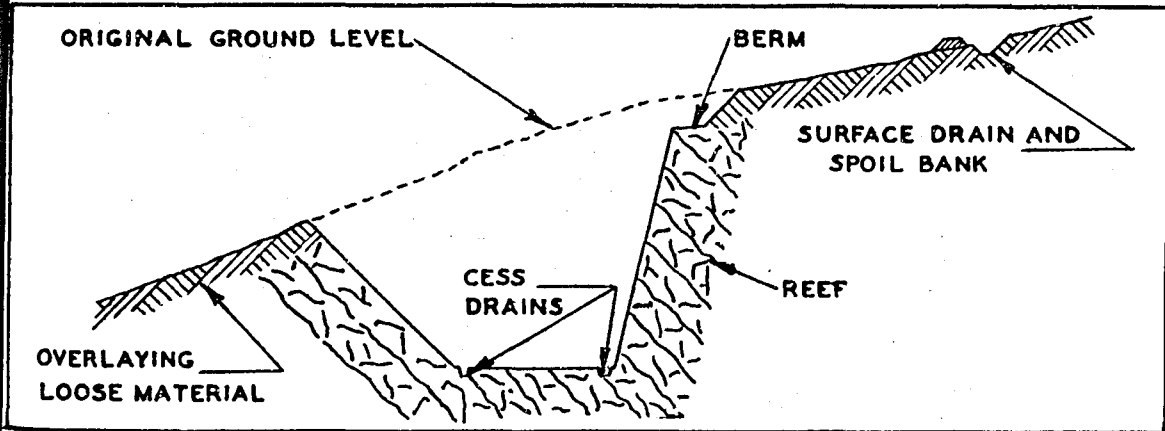

FIG. 3. CUTTING IN REEF-STRATA NOT FAVOURABLE ON LOW SIDE

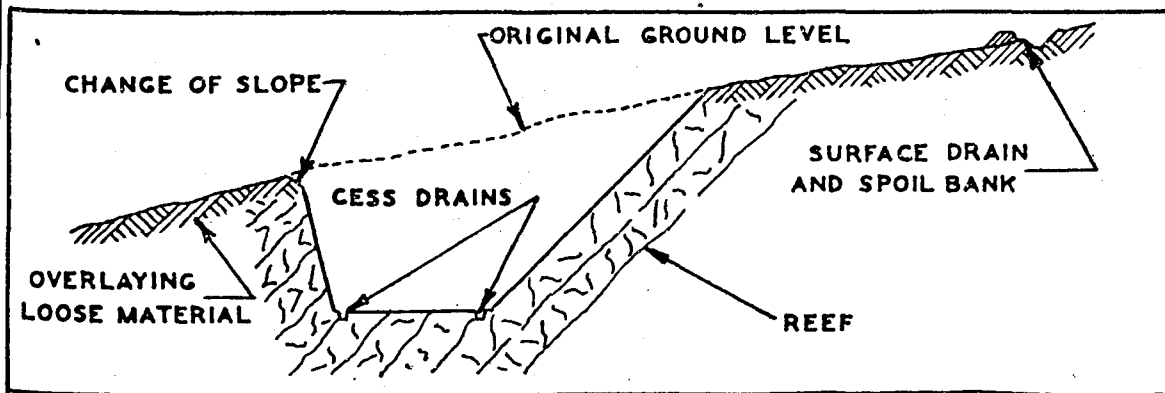

FIG. 4. CUTTING IN REEF-STRATA NOT FAVOURABLE ON HIGH SIDE

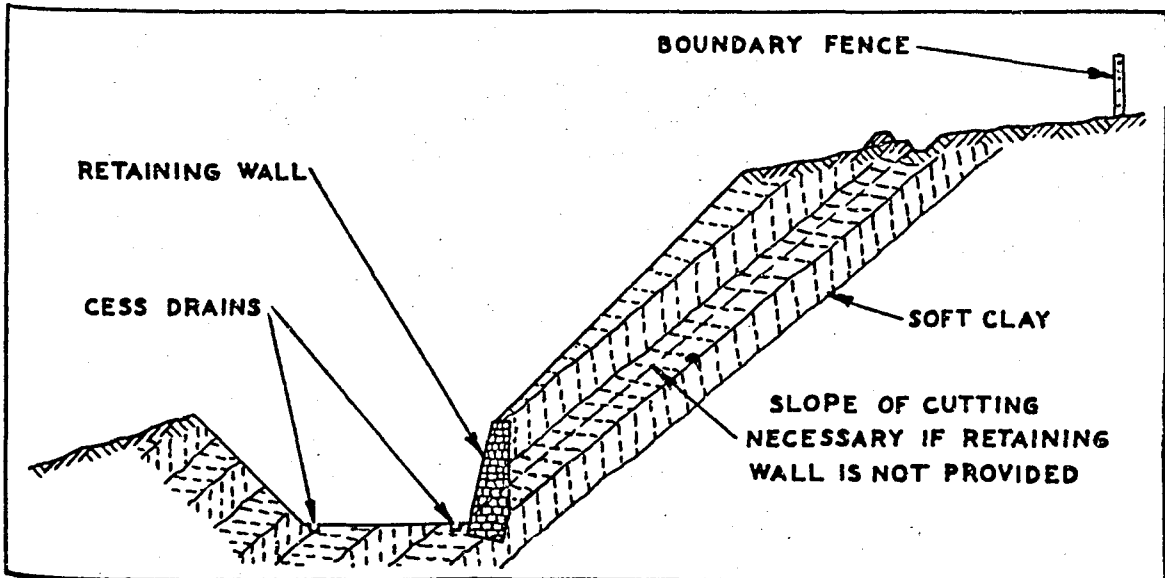

FIG. 5. USE OF A RETAINING WALL FOR CUTTINGS

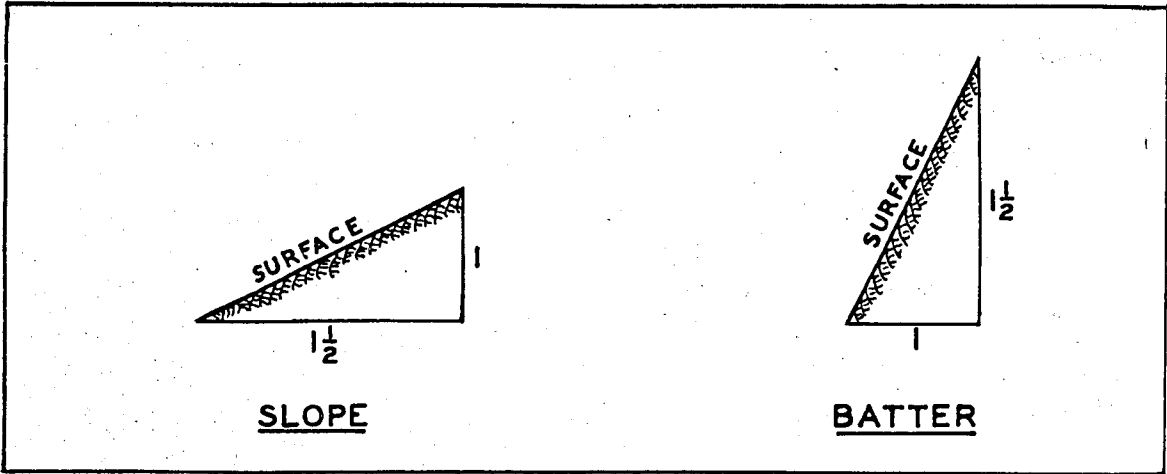

FIG. 6. MEASUREMENT OF SLOPES AND BATTERS

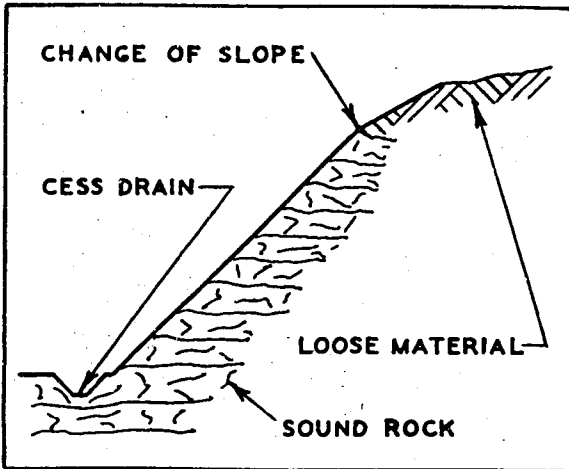

FIG. 7. CHANGE OF SLOPE

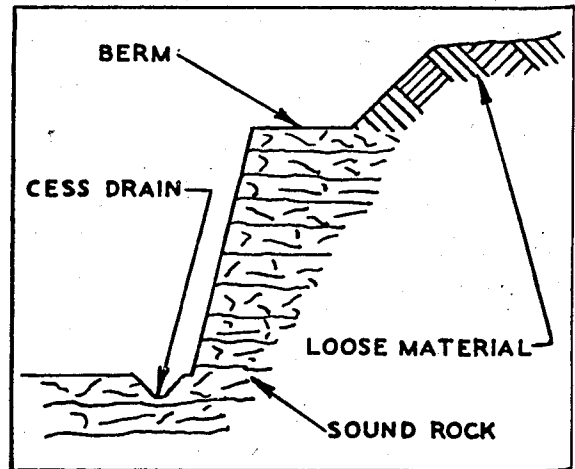

FIG. 8. THE BERM

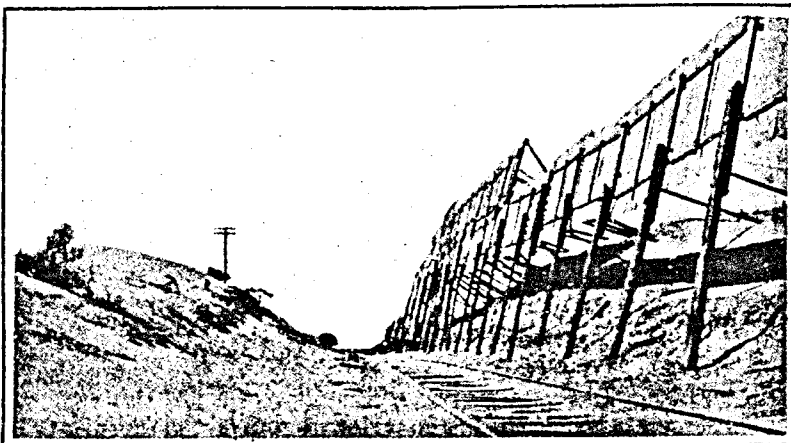

FIG. 9. WIND CHUTES

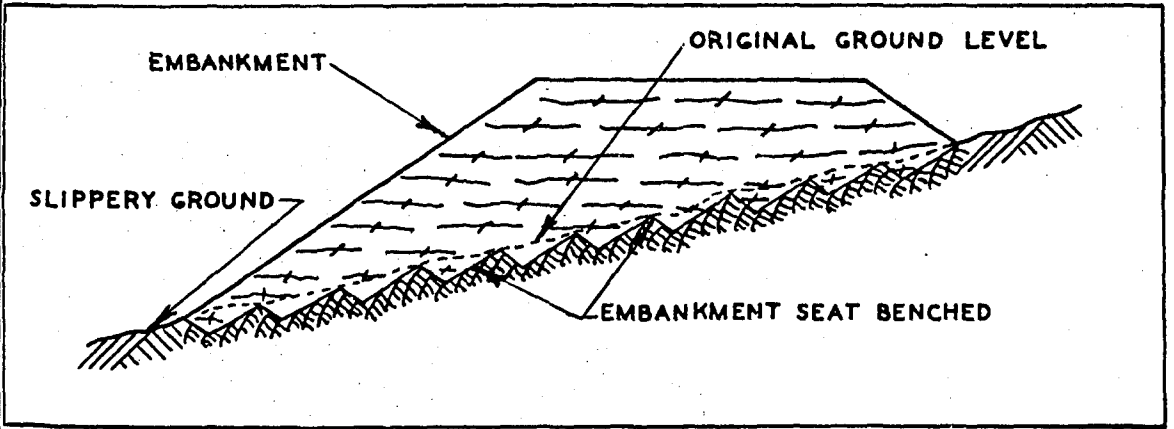

FIG.10. BENCHING OF EMBANKMENT SEAT

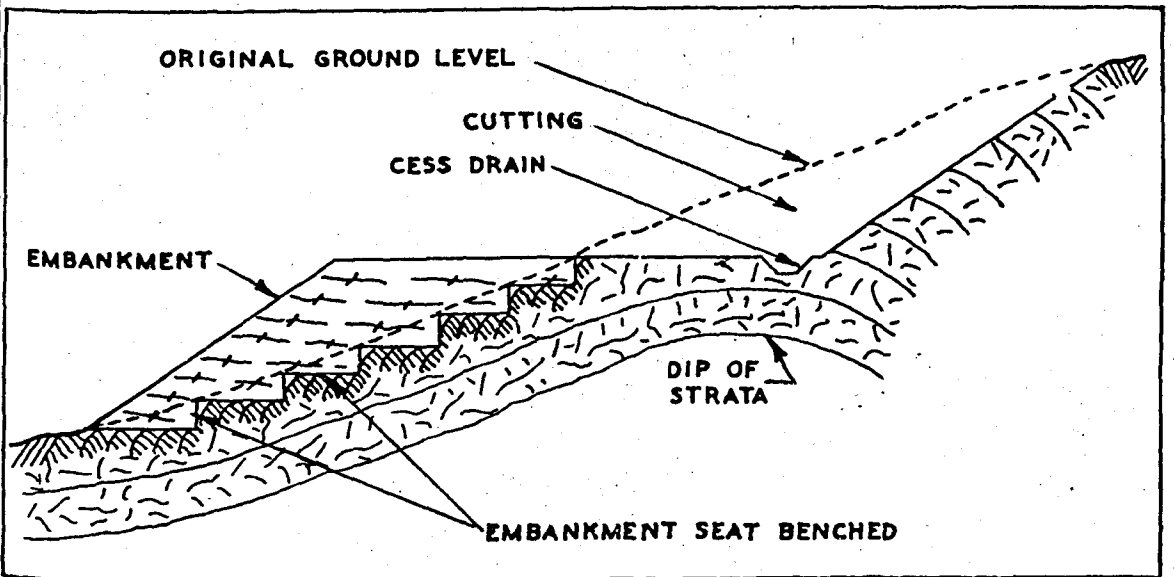

FIG.11. FORMATION PARTLY CUTTING AND PARTLY EMBANKMENT

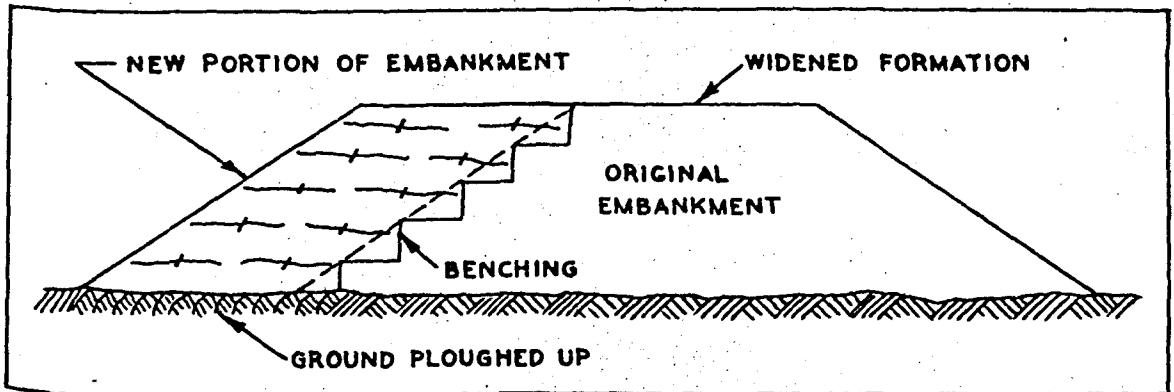

FIG.12. WIDENING FORMATION ON AN EMBANKMENT

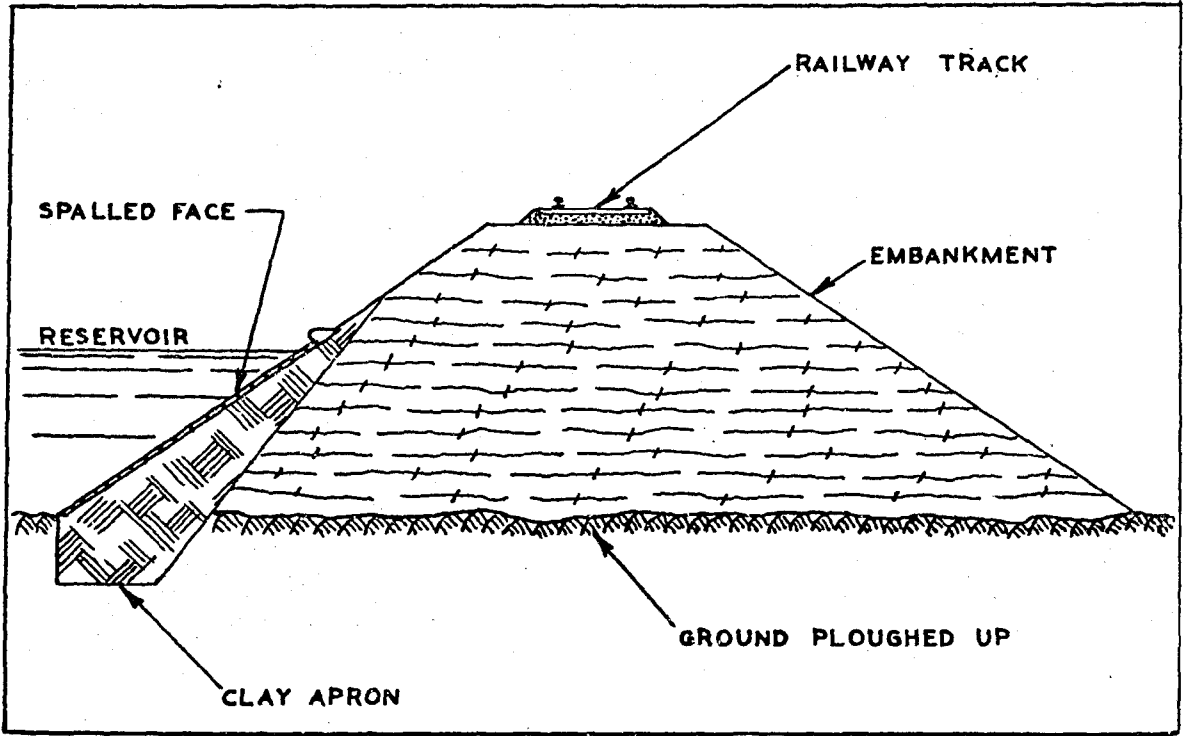

FIG.13. DUAL PURPOSE EMBANKMENT

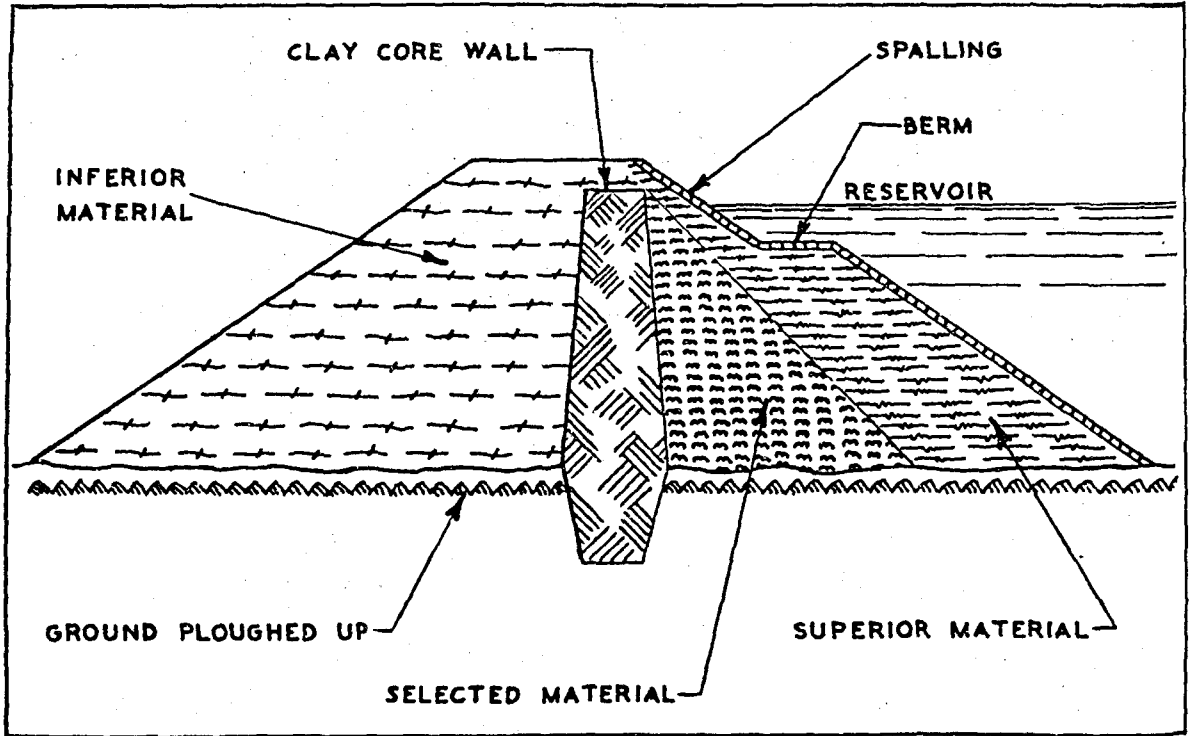

FIG.14. TYPICAL EARTHEN RESERVOIR EMBANKMENT

DRAINAGE. 6.

PURPOSE

Adequate provision for the drainage of the permanent way and regular attention to the drainage systems are essential conditions for economical maintenance.

The purpose of drainage is : -

1. To prevent water flowing on to the formation.
2. To remove water rapidly from the formation.

CLASSIFICATION

Drainage in respect to the permanent way may be classified as follows : -

1. Surface drains.
2. Cess drains.
3. Cross drains.
4. Face drains in cuttings and on embankments.

SURFACE DRAINS

Surface drains are required to lead off surface water from the high side of the track and so prevent the embankments and surface formation from becoming waterlogged, and the ground above the cuttings from becoming saturated.

They should be evenly graded to prevent the accumulation of water in pockets in the drains, otherwise damage may be caused by percolation of this water in unstable ground.

Water collected in surface drains is directed into larger channels or natural watercourses, and by means of culverts, bridges and flood openings is discharged beneath the track.

Surface drains which run parallel with the track should be carefully trimmed to alignment, and to ensure neat work the edges of the drains should be struck out with a nicking line. The soil removed, if not required for other purposes, should be deposited on the low side of the drain and be evenly trimmed to form a guide bank to the drain.

The size of surface drain required depends upon the rainfall and the area draining on to the alignment, the slope and condition of the drainage area and the grade of the drain provided.

Surface drains should be located not less than 6'0" from the edge to the top of cuttings, the toe of embankments or the boundary fence. The minimum size of surface drain provided parallel with the track is 4'0" wide at the top, 1'0" wide at the bottom and 1'6" deep, as shown in Fig. 1.

Surface drains require to be kept clear of debris and weed growth to allow the water to flow freely. On steep slopes and in light surface soil, erosion of the surface drains may develop, and if not treated at an early stage deep scours result and pockets of water are formed at intervals. Scours can be prevented by the use of spalls or old sleeper flooring at soft spots, as shown in Figs. 2 and 3.

When the condition is general over an extended length of drain, the matter should be reported to enable inspection by an Engineer with a view to lining the drain or re-location to a flatter grade if this be possible.

SUBSIDIARY SURFACE DRAINS

These drains are necessary to lead off water discharged at the end of cuttings and accumulating in depressions adjacent to the track.

In hard ground they should be graded to 1 in 50 and be mitre formed as shown in Fig. 4, but in soft ground the grade should be reduced to 1 in 100, which is about the minimum self-cleansing grade. Drains graded flatter than 1 in 200 will not drain freely and any growth of grass permitted in such drains would largely obviate their usefulness.

The mouth or entrance to subsidiary surface drains should be flared outwards to receive the water without constriction. Sharp angles should be avoided where drains change direction; these angles require to be rounded off and the drain be slightly widened to reduce the tendency of blockages occurring with floating debris.

CESS DRAINS

Cess drains are provided in cuttings, as shown in Fig. 5, to intercept and divert surface water from the face of the cutting to the mitre drains at the mouth of the cutting.

The minimum size of cess drain is 1'6" wide at formation level taken down with side batters at 1 to 1 to shovel width. In deep cuttings, where a large area of surface drains towards the track, larger cess drains are provided and in soft materials the drains are lined or underground drains are provided.

As the object of the cess drains is to prevent damage to the formation by the ingress of water, it is essential that the drains be kept free and the floor of the drains be maintained to grade to effectively discharge all water therefrom.

In cuttings the effectiveness of the cess drains is generally reflected in the condition of the formation shown by the number of soft spots found in the track.

CROSS DRAINS

When the formation is of impermeable soil water may collect in pockets, and to permit the escape of this water cross drains are necessary. These drains should be about 12 to 18 inches wide and be taken down to the bottom of the water pocket; they should be graded about 1 in 50 to their outfall if back filled with rubble.

On very wet ground, before tipping the embankment material, cross drains may be provided under the seat of embankments by laying rubble drains to provide permanent sub-drainage.

Sections of track through cuttings or on embankments prone to the development of soft spots are now provided with cross drains situated according to requirements.

In some instances open jointed pipes are laid in a graded trench back filled with rubble and the outlets are connected to the cess drains and side drains. The outlets to such drains should be regularly inspected and all obstructions be removed to enable the drains to function properly.

The necessity for cross drainage will be apparent from Fig. 9. See 5.03.

FACE DRAINS

These are sometimes required to drain the surface of cuttings in bad ground or high embankments made of impermeable soil.

The drains may be graded, back filled with rubble, with or without open jointed pipes, and be arranged in a pattern as shown in Fig. 6. As surface silt is carried into face drains, cleaning and re-setting of the rubble may require frequent attention.

Such drains are steeply graded to remove the water rapidly, otherwise in cuttings the water may percolate through the low side of the drains back into the soil and cause a slip of the face.

UNDERGROUND DRAINS

In narrow cuttings, in tunnels, through station pits, and in station yards where open drains cannot be provided, use is made of underground drains.

For the intake of soakage water, open jointed pipes are provided, but for the discharge of the water so collected, jointed pipes are laid to grade with suitable outfalls. As all pipe drains are subject to siltation and blockage, it is necessary to provide inspection pits at intervals to enable removal of the silt.

These pits are constructed deeper than the invert of the pipes and form a trap for the silt; when surface drainage is received into jointed underground drains suitable gratings are provided to cover the pits, otherwise timber covers are provided. Debris must be kept clear of all gratings and ballast should not be permitted to overlay the timber covers.

Blockage of underground drains may cause serious damage by diverting water into the formation, and indications that blockage is occurring is evident when the water in the pit is above the invert of the outlet pipes. If a satisfactory clearance cannot be effected, the matter must be immediately reported to enable suitable equipment to be provided for clearing the drains.

Rubble filled drains become progressively blocked by soil and debris, and after a few years may require to be opened out and the material cleaned or fresh material set in position. In bad ground the pipes may be displaced by movement of the ground and require to be partly or wholly re-graded and re-aligned.

A typical arrangement of drainage facilities is shown in Figs. 7 & 8.

SEEPAGE

In tunnels and cuttings, water bearing strata may be intersected and result in continual seepage of water. When this seepage occurs below formation level, soft spots will develop in the track although water may not be in evidence on the formation. To deal with these conditions pipe drains leading to deep cess drains may be necessary.

The arrangement of drains in the Jolimont-West Richmond tunnels, shown in Fig. 9, is an example of this class of drainage.

WATER POCKETS

The causes and extent of water pockets vary with the condition of the track and the nature of the formation.

Formation varies with the location and may be considered broadly under four headings : -

1. Surface formations.
2. Deep cutting formations.
3. Shallow cutting formations.
4. Embankment formations.

SURFACE FORMATIONS

The development of shallow water pockets in surface formation may arise from any of the following conditions of track : -

- (a) The use of light rails and worn fishplates.
- (b) Weak and broken sleepers.
- (c) Wide sleeper spacing.
- (d) Faulty or neglected packing.
- (e) Insufficient depth of good ballast below the sleepers.
- (f) Faulty or neglected weeding.
- (g) Heavy axle loads and high speeds.
- (h) Accumulation of water on the formation.

Under these conditions depressions are formed at intervals in the formation, and the movement of the track under traffic tends to enlarge the depressions. See 3.04.

DEEP CUTTING FORMATIONS

Water pockets in deep cuttings may occur as a result of irregularities in the original excavations and the subsequent levelling off of the formation with loose materials. If the floor of the cutting is of impermeable material, water is retained in the original hollows and soft spots develop.

To deal with these conditions this plastic material should be removed and the depression be back filled with sound material, preferably of a heavy compact nature, which should be well rammed and consolidated in position.

SHALLOW CUTTING FORMATIONS

In shallow cuttings, or at the mouth of deep cuttings where the plastic clays have been exposed to form the formation, the pockets may occur under the packing area of numerous sleepers owing to the ballast being forced into the yielding formation.

When this condition obtains at several adjacent sleepers an extensive bog hole may develop. An arrangement of drains provided to treat this condition is shown in Fig. 10.

EMBANKMENT FORMATIONS

Water pockets in the formation of embankments are generally caused either by : -

1. Subsidence of the formation under rail joints or in areas insufficiently consolidated or composed of inferior materials.
2. Enclosing the formation in a gutter by building up the shoulders of the embankment with impermeable material above the formation level.

It is generally found that water pockets in "embankments" arising from subsidence are deeper than in cuttings due to the looser nature of the material.

If these pockets are connected, a rubble drain or pipe drain back filled with spalls will provide the necessary drainage if put in to tap the water at the lowest point and drained outwards to the shoulder of the embankment. Isolated pockets may be treated by digging out the plastic materials and filling with sound material.

When stretches of track are waterlogged, due to bank rebuilding, it is necessary to cut through the impermeable material at the shoulder at frequent intervals to form outlet drains. These outlets should be put in from 50 to 100 feet apart according to the grade of the track and the condition of ballast and formation. A method of treating this condition is shown in Figs. 11 & 12.

PUMPING

When water is present the vertical depression of the track forcibly ejects the water which carries out the finer particles of earth materials thereby enlarging any hollow in the formation.

Repeated vertical movement under the action of traffic causes the water to flow in and out in much the same action as a water pump. The inflow of the water is relatively slow and the materials eroded and ejected are not restored by the back flow of the water.

This condition can be treated by cleaning out the depressions and restoring the formation with sound materials, but the inherent defects of the track must be corrected to effect permanent repair.

An increase in the resistance of the formation to depression and bulging may be effected by : -

1. Good drainage.
2. Increasing the area of pressure distribution by the use of additional sleepers, and when practicable, a greater depth of good clean ballast.

A general condition of waterlogged track may arise with certain gravel ballasts having a high percentage of fines which settle and compact at the shoulder of the track profile thereby enclosing water under and around the sleepers. In the absence of better ballast the condition can be temporarily improved by breaking up the shoulder ballast to enable the escape of the water.

SPOT GROUTING

A recent development in the treatment of water pockets in track consists of forcing cement grout or asphalt-cement grout into the pocket to displace the water and prevent further accumulation. The grout is forced through injection pipes driven through the shoulder ballast into the plastic formation as shown in Figs. 13 & 14.

This system is now well established in America where power operated equipment is available for mixing and pumping the grout through hoses connected to the injection pipes.

As the injection pipes are driven outside the gauge, grouting is carried out without interference with traffic. After the grouting is completed the injection pipes are withdrawn and the equipment moved forward to the next grouting point.

P.C.R. CROSSING DRAINAGE

Surface drainage at public carriage road crossings should be diverted from the track and different drainage arrangements are provided according to local conditions.

Roadways inclining towards the track as in Figs. 15, 16 & 17, are usually provided with some form of intercepting drains to receive and dispose of the water.

Whatever type of drainage is provided, blockages will occur sooner or later and to avoid water flowing on to the track, the drains should be frequently cleaned.

WATERWAYS

Waterways are provided by bridges, culverts and flood openings. See 4.06-4.07. At the entrances to these waterways, wing walls are provided to prevent scour and to receive the water without constriction.

The size of the waterway provided is dependent on the estimated quantity of water to be dealt with, and should an obstruction occur at these locations, water will be dammed back against the embankments.

Under these conditions saturation of the embankment will take place and further accumulation of water may result in scouring or failure of the embankment. It is therefore of considerable importance that all debris likely to form an obstruction be removed at the earliest opportunity.

CATCHMENT DRAINS

Catchment drains, to collect and deliver surface water into railway reservoirs, are usually open surface drains and may extend for some distance from the reservoir. These drains vary in size according to the area drained and usually follow approximately the contour of the country.

Regular inspection of catchment drains is necessary to ensure that blockages and scours do not take place. Blockages have a two-fold effect : -

1. They cut off the water required to replenish the reservoir storage.
2. They divert water to adjoining country and may result in damage to property due to flooding, scouring, or saturation.

When catchment drains traverse private property the Department will have an easement or a legal arrangement with the owners for the rightful use of the drains and any interference by the public or land-owners should be reported.

LATERAL DRAINS

Lateral drains are cut to collect and deliver surface water into catchment drains and the quantity of water collected depends largely on the effectiveness of the lateral drains.

DIVERSION DRAINS

Diversion drains are cut to deliver water from running streams to reservoirs or pipe heads. Weirs controlling the quantity of water and gratings to restrain the ingress of debris may be provided and these must be regularly inspected and blockages be removed.

OUTFALLS

The excess water accumulated in reservoirs is discharged by means of outfalls. These outfalls are usually open drains described as by-washes, and may be lined or unlined according to the nature of the soil in which they are excavated. Pipe outfalls are in use on some small dams and excavated reservoirs enclosed within spoil banks.

Debris must not be allowed to obstruct the free outfall of water, otherwise there is a danger of the embankments being overtopped and scoured out.

Scours developing on the down stream side of the outfall should be carefully watched and protection should be provided by the use of spalls or sleeper flooring. If the scours cannot be checked by these measures the matter should be reported to enable an Engineer to investigate permanent remedial measures.

CUT-OFF GATES

When the flow of water to a reservoir is controlled cut-off gates or sluices are provided and should be operated in accordance with special instructions pertaining to the location. Trackmen concerned with the operation of these devices should ascertain from their supervising officer the circumstances in which these controls are to be operated, otherwise the continuity of water services may be interrupted.

SEWERAGE OUTFALLS

The outfall from sewerage and septic tank installations must not be permitted to enter catchment drains leading to reservoirs, and any difficulties associated with the disposal of the effluent should be reported for engineering attention.

DIVERSION OF WATER

Surface water must not be diverted on to adjoining lands other than at natural waterways; conversely the owners or occupiers of adjoining lands must not be permitted to divert drainage into railway drains without authority from the Department.

PIT DRAINAGE

Ash pits, turntable pits, weighbridge pits, and subways are drained according to location; where practicable pipe drains lead to a main drain system or convenient outfall, but if no suitable outlet is available, the water must be elevated to surface drains or piped to soakage pits. Where soakage pits are provided care must be taken to prevent the ingress of debris which would tend to block the pits and interfere with the disposal of the water.

Syphons, handworked pumps, power operated pumps and windmill pumps are provided at various locations for the elevation of pit water, and special instructions are issued for the care and operation of this equipment.

Regular attention should be given to cleaning debris from the entrance to suction pipes as the equipment is usually controlled by float mechanisms and will, if the inlets are obstructed, continue in operation without removing the water.

Pressure operated water ejectors may run continuously if either the inlet or outlet is obstructed, and if badly blocked may back flow into the pits.

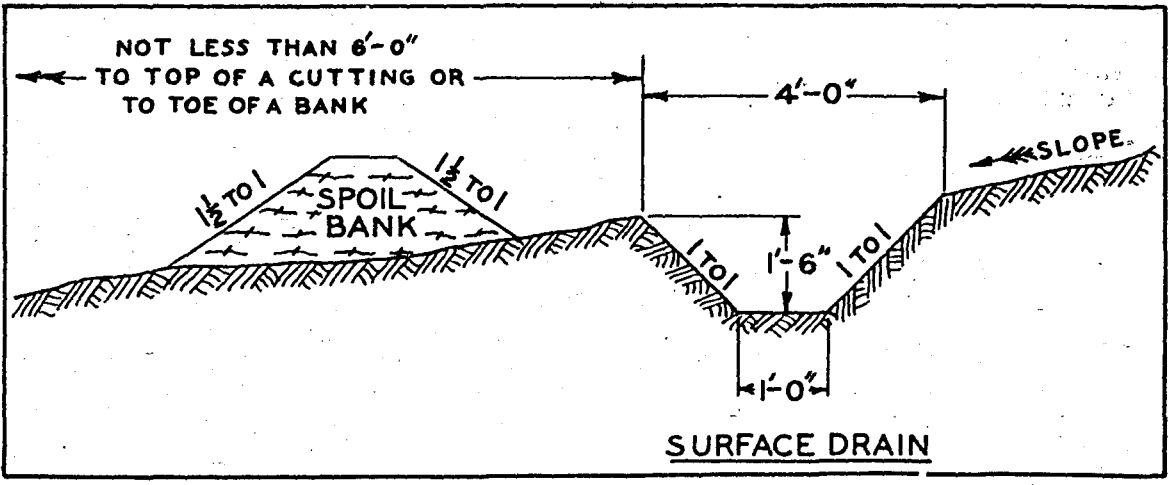

FIG.1. THE MINIMUM DIMENSIONS OF A SURFACE DRAIN

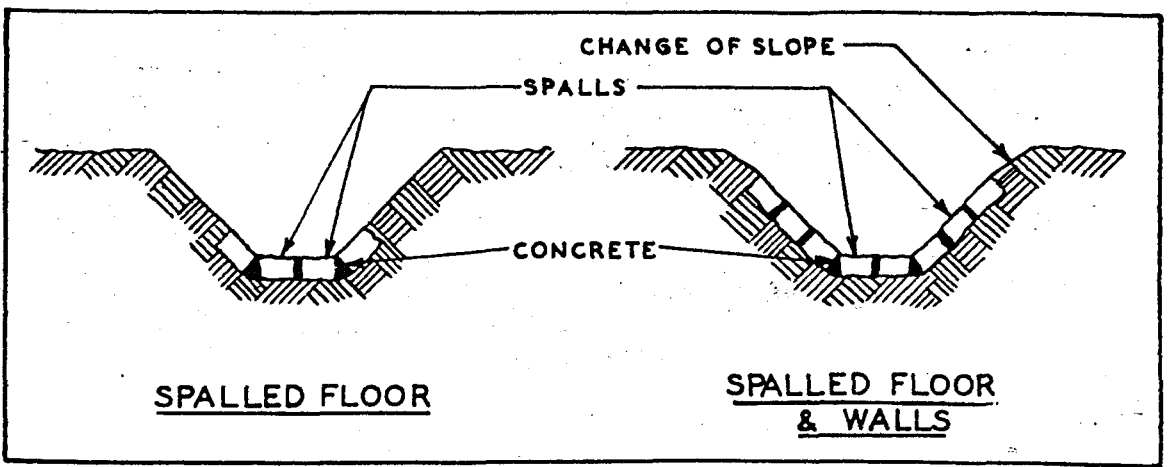

FIG.2. THE USE OF SPALLS TO PREVENT SCOURS

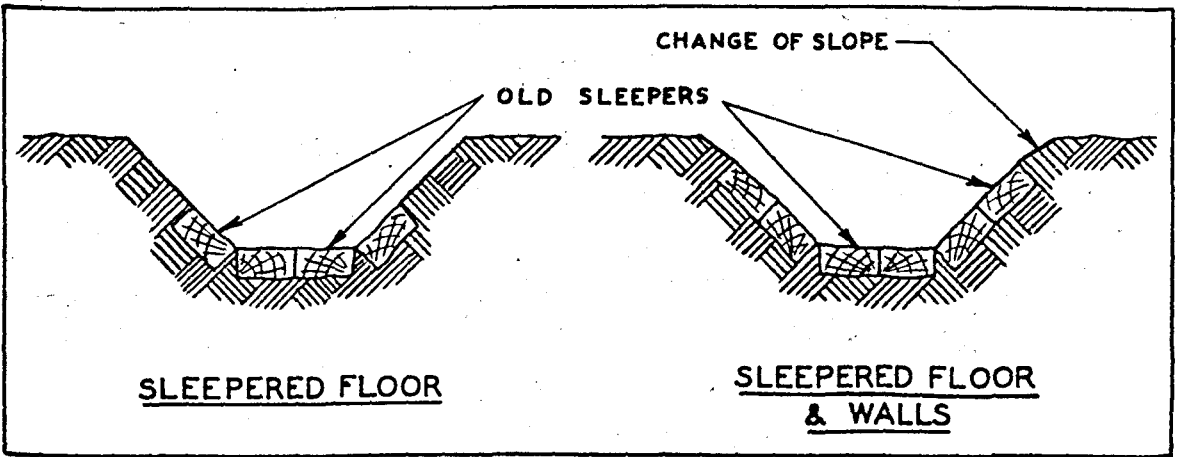

FIG.3. THE USE OF OLD SLEEPERS TO PREVENT SCOURS

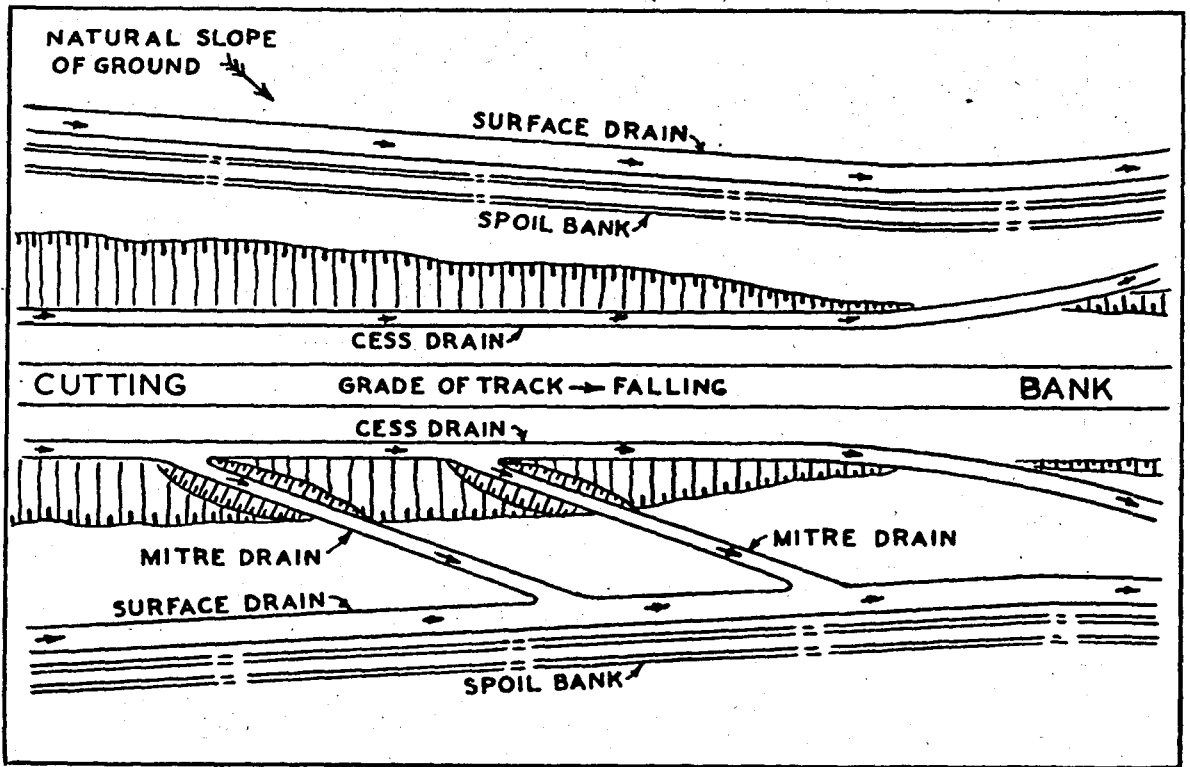

FIG. 4. MITRE FORMED SUBSIDIARY SURFACE DRAINS

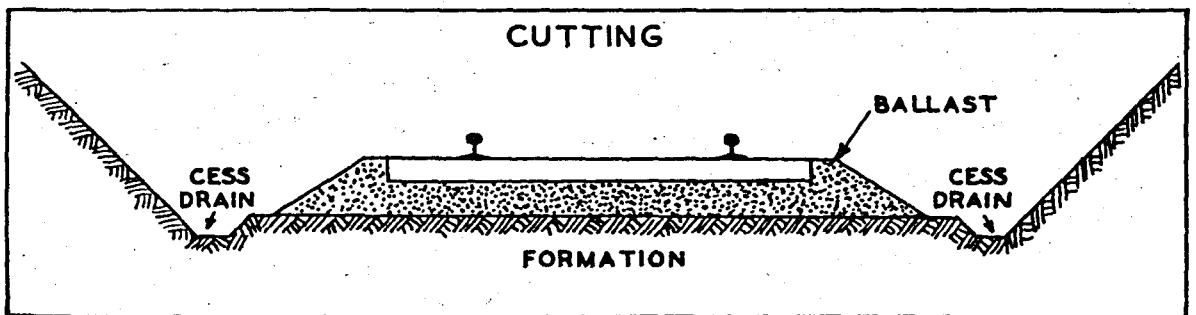

FIG. 5. CESS DRAINS

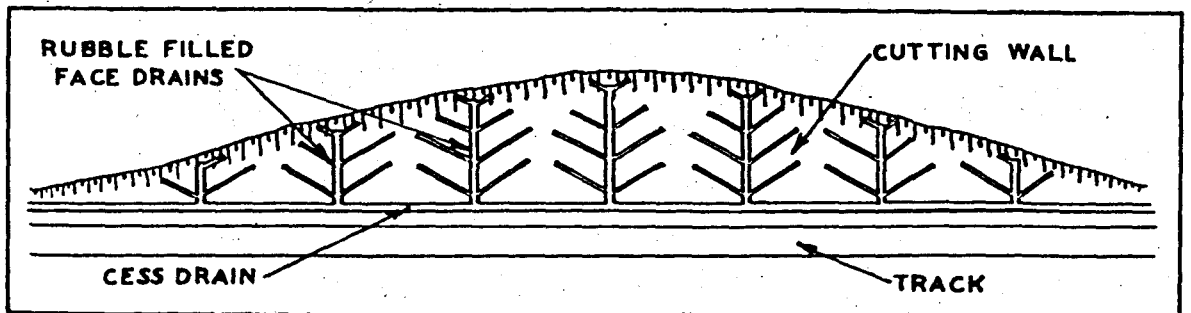

FIG. 6. FACE DRAINS IN A CUTTING

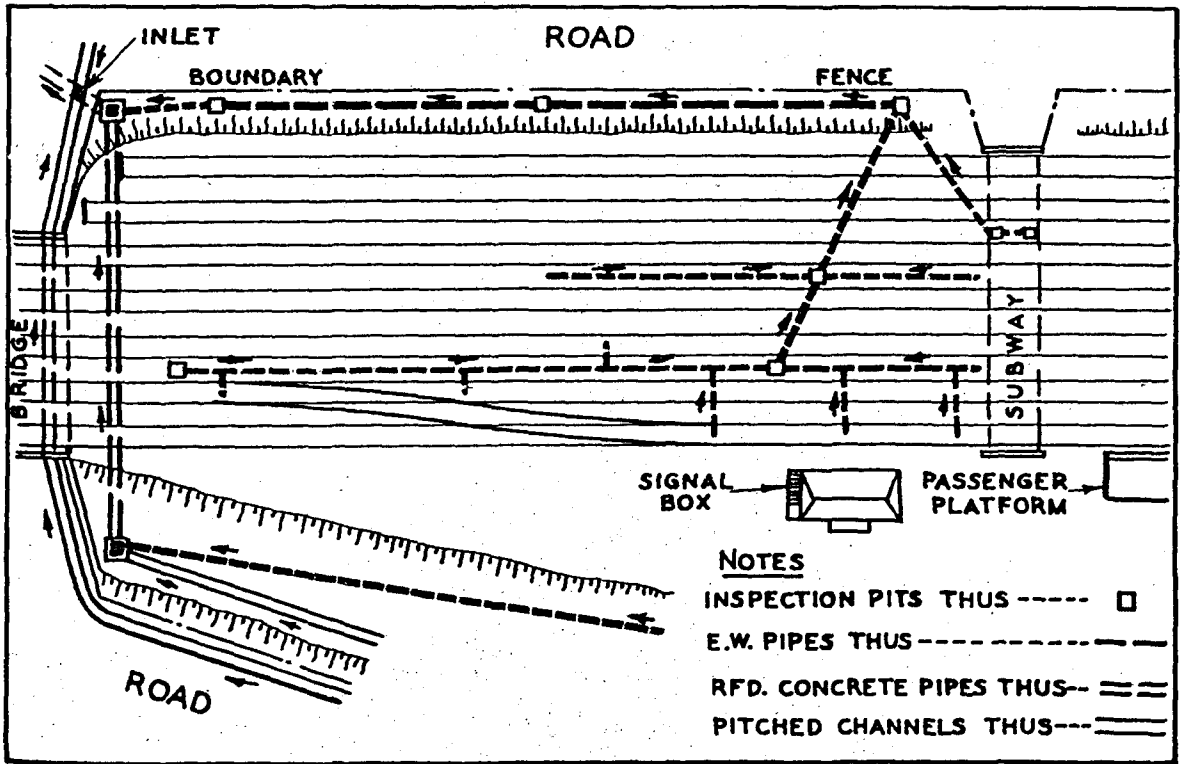

FIG. 7. TYPICAL DRAINAGE FACILITIES IN A BIG STATION YARD

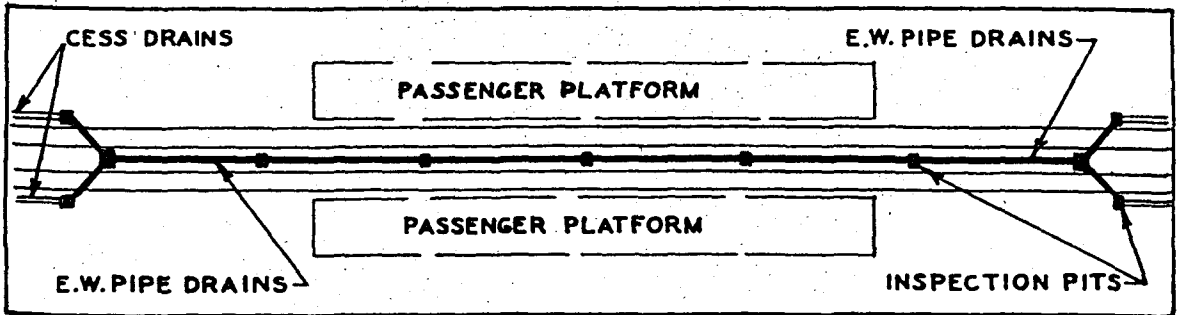

FIG. 8. TYPICAL DRAINAGE FACILITIES IN A SMALL STATION YARD

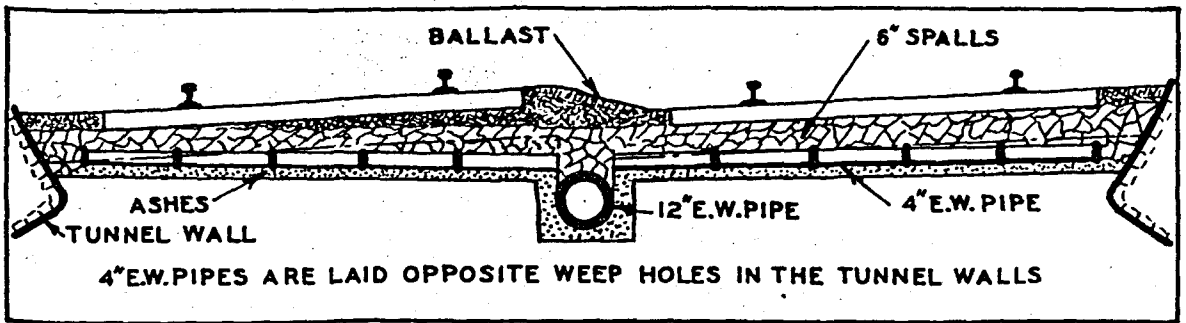

FIG. 9. ARRANGEMENT OF DRAINAGE - JOLIMONT - WEST RICHMOND TUNNELS

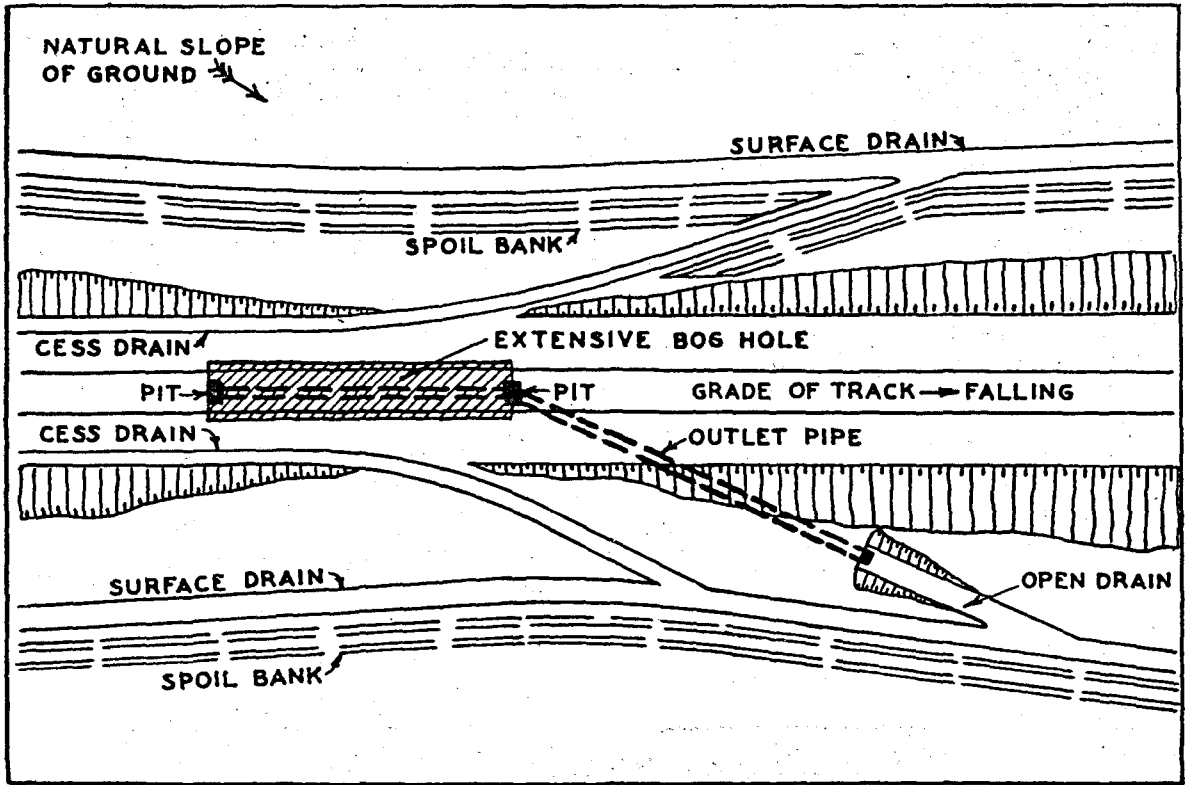

FIG.10. DRAINAGE OF AN EXTENSIVE BOG HOLE

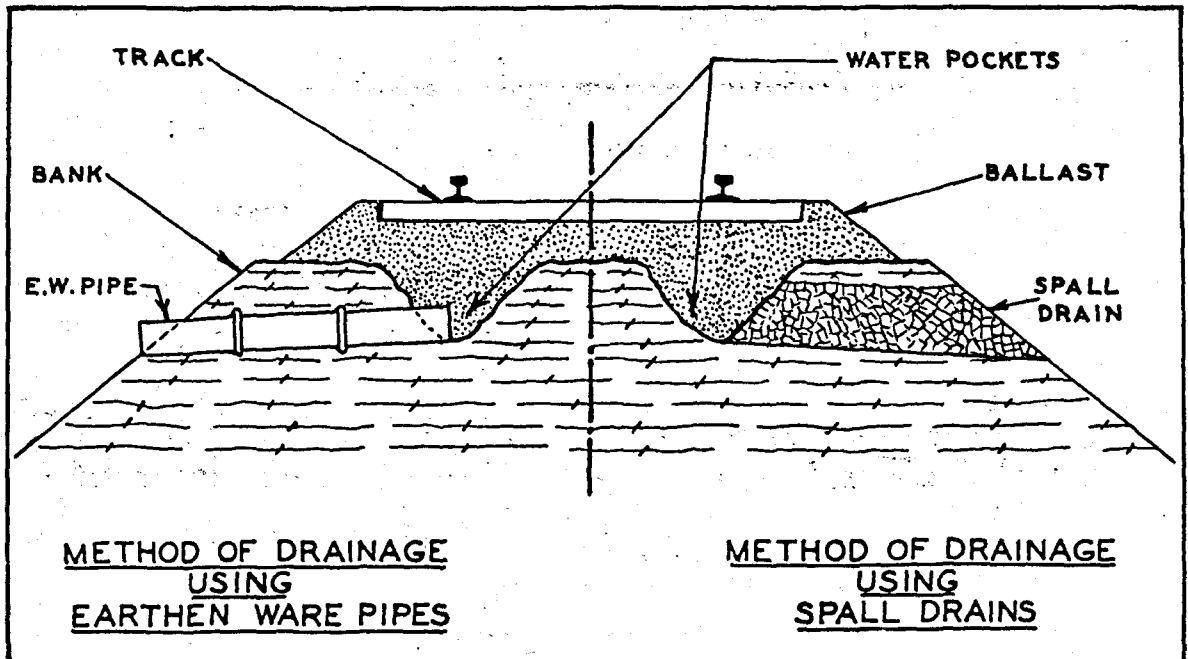

FIG.II. ALTERNATIVE METHODS OF DRAINING WATER POCKETS

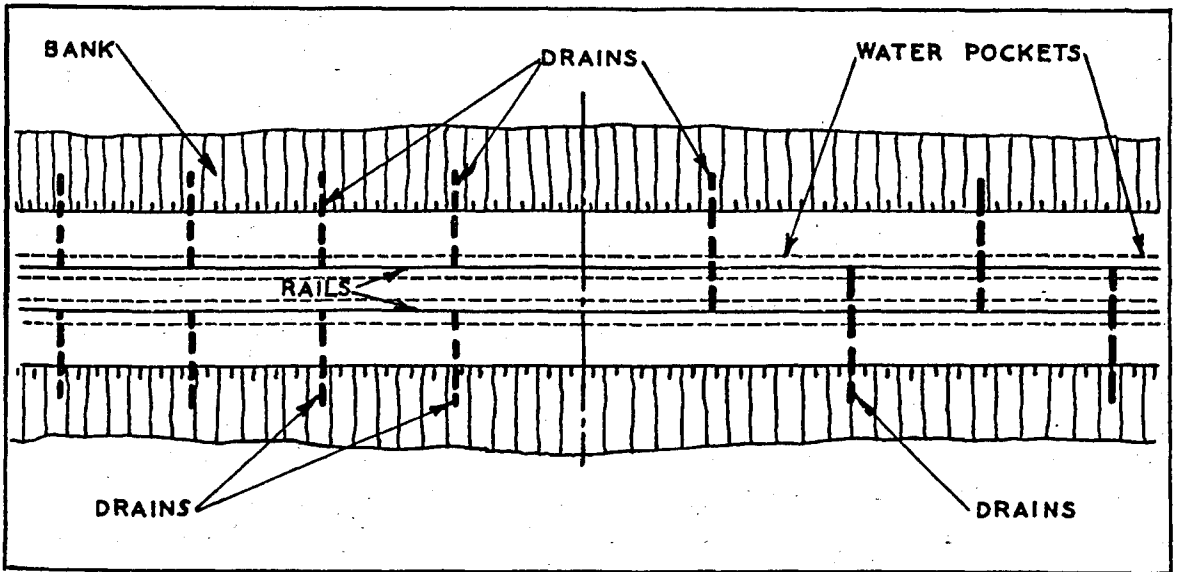

FIG.12. ALTERNATIVE METHODS OF PLACING DRAINS SHOWN IN FIG.11.

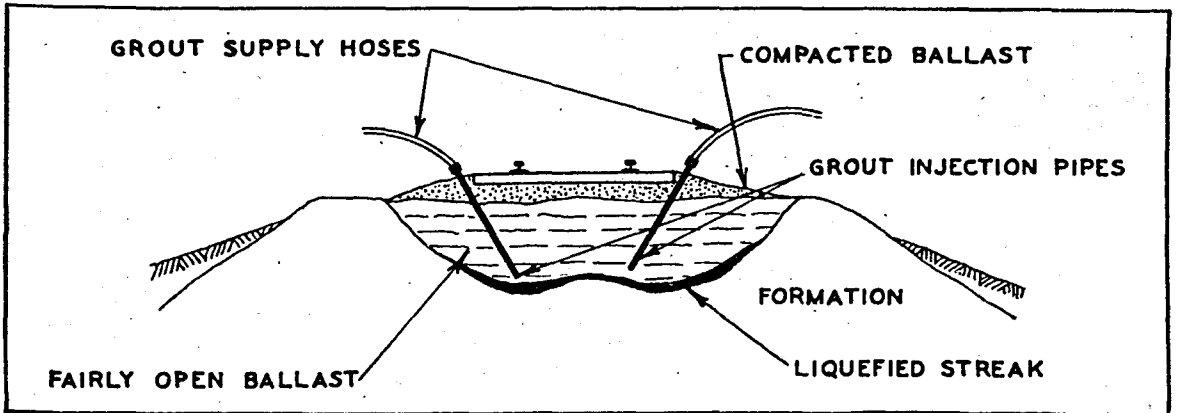

FIG.13. TYPICAL SPOT GROUTING

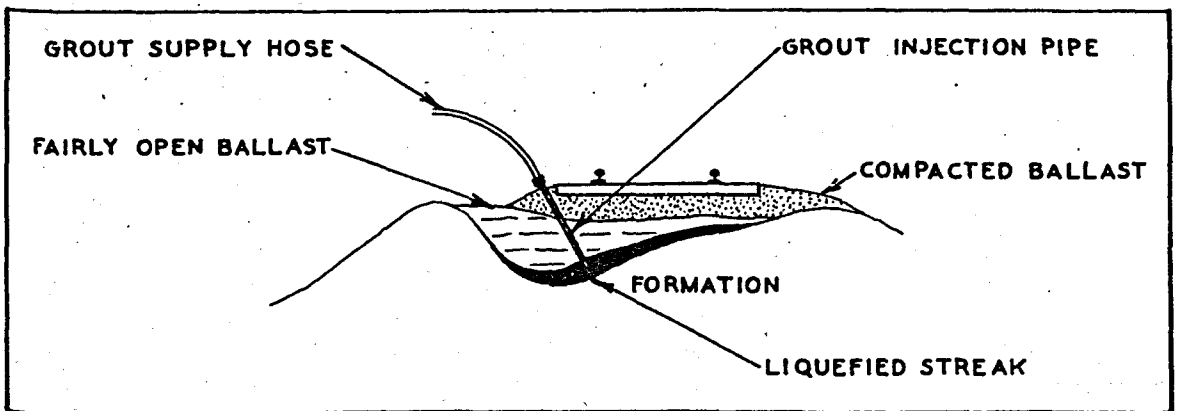

FIG.14. TYPICAL SPOT GROUTING

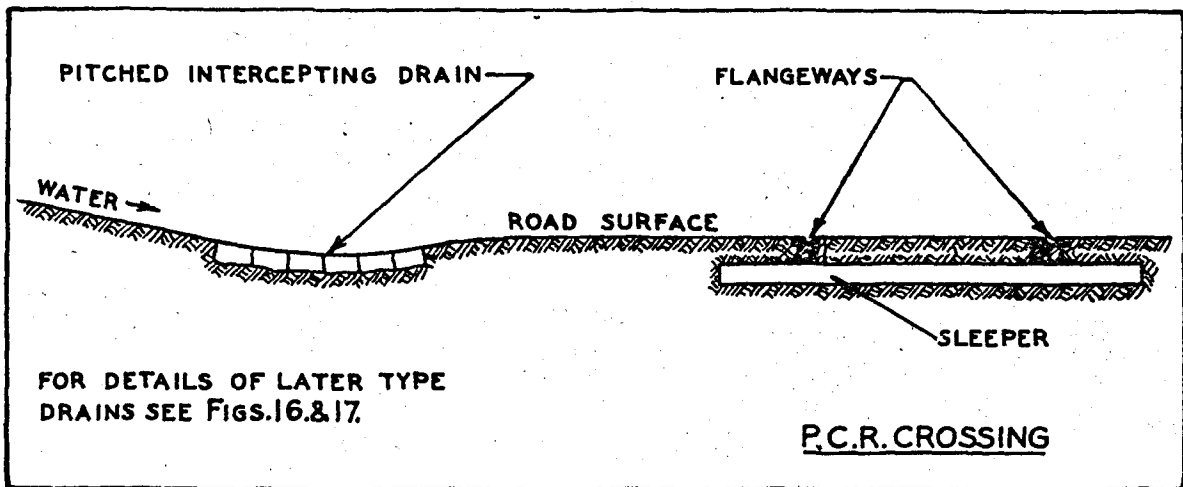

FIG.15. ORIGINAL P.C.R. CROSSING INTERCEPTING DRAIN

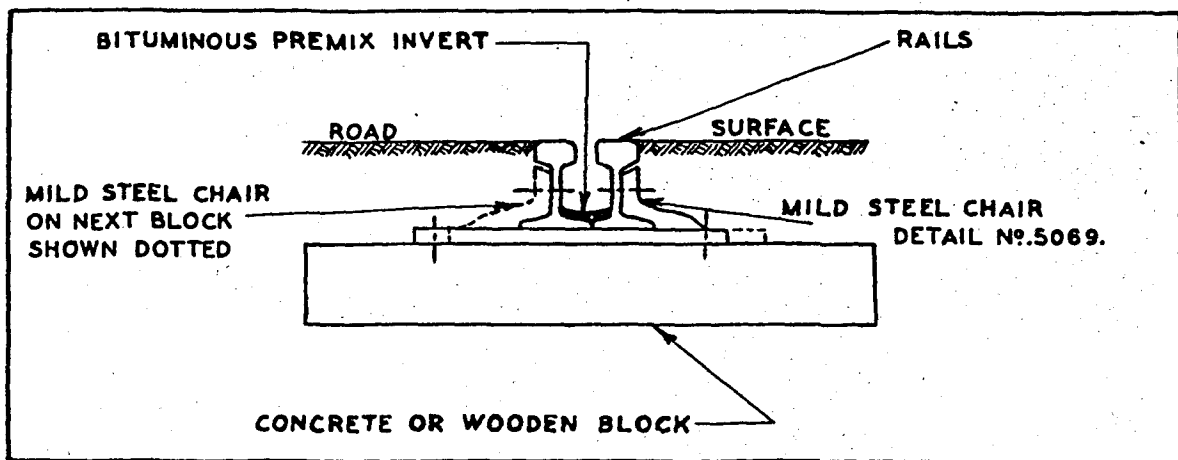

FIG.16. ONE METHOD OF PROVIDING AN INTERCEPTING DRAIN

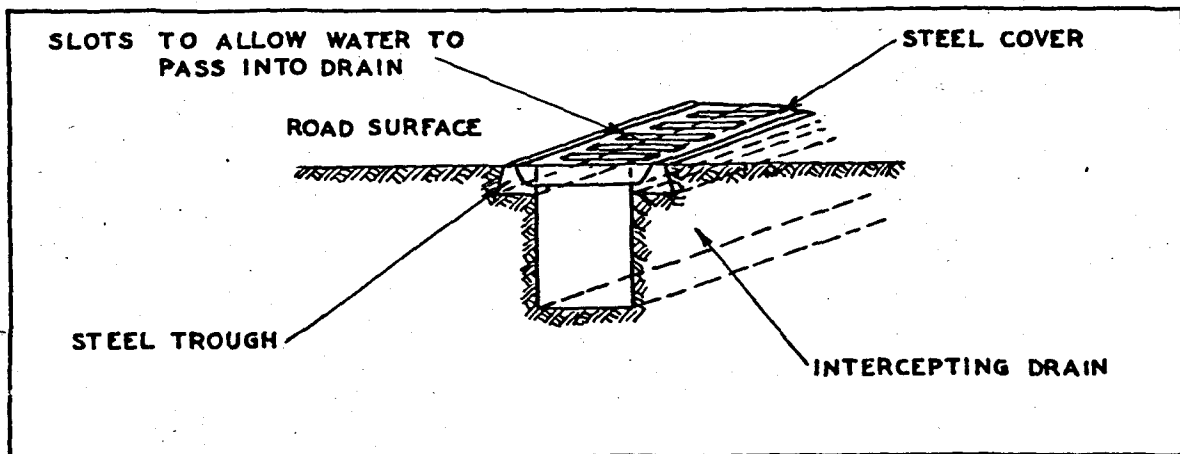

FIG.17. INTERCEPTING DRAIN WITH SLOTTED STEEL COVER

BALLAST. 7.

PURPOSE

Ballast is the foundation material of the track structure serving to transfer the weight of the traffic from the sleepers to the formation. The stability of the track and its riding qualities are largely influenced by the quality of the ballast.

ESSENTIAL FUNCTIONS

The essential functions of the ballast are : -

- (1) To properly support and keep the track in line.
- (2) To adequately distribute the weight of the traffic on the formation.

Any material which does not satisfy these two conditions is unsuitable.

Further and important purposes served by the ballast are : -

- (3) To provide drainage from the track structure and the surface of the formation and so reduce local sinkage and vertical deformation of the track.
- (4) To provide a cushion between the track structure and bridge decking or hard formation.
- (5) To give longitudinal support by boxing in and so reduce creep.
- (6) To provide a means of surfacing the track without disturbing the formation.

QUALITIES

Ballast to fulfil these requirements should possess the following qualities : -

- (a) It should be clean and free from dust, drain freely and not encourage the growth of weeds.
- (b) It should be a tough angular material with a rough surface and capable of locking together to form a stable mass.

- (c) It requires to be heavy to hold the track in line and retard the creep of the sleepers.
- (d) It should be hard and durable and offer strong resistance to crumbling under the impact of traffic, or in the course of beater packing.

Other desirable features are : -

- (e) Easy to handle.
- (f) No detrimental effects upon sleepers, fastenings, rolling stock, or trackmen.
- (g) Available in large quantities at reasonable cost.

The classes of ballast which have been used in Victoria are Basalt, Quartz, Granite, Sandstone, Shales and Slates, Limestone, Gravels, Ashes, Scoria and Sand, and their properties are as follows : -

BASALT

Basalt, commonly known as bluemetal or bluestone is a hard, heavy, compact and comparatively tough stone which offers a strong resistance to crumbling or powdering under load pressure or under the beater.

The pieces are fairly angular in form and readily lock together, thus making it very suitable for the distribution of the load on the formation. It weathers well and is not unduly difficult to handle. If properly packed it has little detrimental effect on the sleepers and none at all on the fastenings. Having practically no glare, it is not fatiguing to the eyes of trackmen, whilst its cost is not excessive.

QUARTZ

Reef Quartz broken to gauge does not make good ballast for the following reasons : -

- (a) Owing to its being too brittle it will 'fly' when being beater packed.
- (b) When broken the fracture presents a smooth surface like glass and this, combined with its hardness, allows the stones to slip when they are subjected to load pressure, unless in a confined bed.
- (c) As the Quartz is white the glare is very pronounced in Summer.

GRANITE

Granite makes a fairly good ballast when it is broken to $1\frac{1}{2}$ inch gauge, but it is not as good as Basalt. It is brittle and there is a certain amount of glare from it in Summer.

SANDSTONES

Sandstones vary in quality, most being unsuitable as they crush under load pressure, particularly when wet, so that they are reduced to sand again. Some very hard sandstones occur, but these have not the wearing qualities of Basalt.

SHALES AND SLATES

Shales and Slates are generally too soft or too flakey and brittle for use as ballast, but occasionally deposits occur which are suitable and give fair service. The Shale from Coldstream is a good material but it differs from Basalt in not being so hard and is of a yellowish color. Being slightly softer it wears out and becomes dirty more quickly than Basalt. The Shale from Wandong is the color of Basalt and closely resembles it in appearance, but it is finer grained. This makes fair ballast, but soon crushes under load pressure and beater packing.

LIMESTONES

Limestones vary in quality, the hardest being the best. The softer variety is, however, a much inferior article, particularly when wet, as it lacks to a great degree the supporting power and the load distributing quality of the harder kind. Furthermore, there is a considerable admixture of fine material, and this tends to prevent the proper drainage of the track thereby softening the formation. In districts where the rainfall and traffic are light, these disabilities may not be a serious objection.

GRAVELS

Gravels make a good ballast when the traffic and rainfall are light, but the gravel must be clean and of a depth of not less than 6 inches. Clean gravel does not clog, but allows free drainage of the track and the load pressure is well distributed over the formation.

Dirty gravel clogs and prevents free drainage so that the sleepers puddle the ballast which sinks into the formation, and the track becomes 'nippy' and ultimately centre-bound during dry weather if not properly attended to. The earthy material in dirty gravel is also conducive to the free growth of weeds.

ASHES

Ashes (coal cinders) are widely used and make a good ballast where the speed is not too high.

The advantages are : -

- (1) As the grains are fairly hard and rough they lock and give support to the track. The load pressure is well distributed on the formation.
- (2) The elasticity reduces the shock, or jar, upon the track making the running much easier.
- (3) Ashes being porous absorb a considerable amount of water which later evaporates without percolating to the formation.
- (4) They are light and easily handled.
- (5) Weeds do not readily grow in them.
- (6) Transport is the only cost.

Disadvantages are : -

To some extent the lightness of ashes is a disadvantage as they do not resist lateral or side movement to the same extent as the heavier ballast.

As ashes have a corrosive action on steel rails it is essential they be kept clear from contacting the rails and their fastenings.

SCORIA

Scoria (volcanic cinders) has similar good qualities to coal cinders. Scoria is much coarser than coal cinders and is not so easily handled, but it is also heavier and makes the track more stable.

SAND OR LOAMY SAND

This is one of the poorest ballasts, being used only in dry districts with light traffic when no better ballast can be obtained without heavy expenditure. Sand particles are smooth and do not lock together. Water is absorbed but does not evaporate quickly. In wet districts it quickly becomes slush, and in dry districts it drifts with the wind. In very dry weather passing trains lift it in clouds causing discomfort to passengers and trouble with rolling stock.

GENERAL

The gauge of metal ballast is determined by the diameter of a ring through which it will pass, and the different gauges of metal are obtained by screening the metal after it is crushed, the holes in the screen being the size desired, i.e., $2\frac{1}{2}$ " diameter holes for $2\frac{1}{2}$ " gauge metal.

The circumstances which influence the use of a particular ballast are : -

- (a) The speed of trains, the axle loads and wheel spacing.
- (b) Density of traffic over the track.
- (c) Average rainfall in the locality.
- (d) Cost of providing the ballast.

On main tracks where speed is high and on electrified tracks where the traffic is dense, only the best available ballast is used, but where speed is low and axle loads comparatively light, average rainfall low and the service limited, a comparatively low grade ballast may effectively meet requirements.

Sidings are usually ballasted with gravel or ashes depending upon the grade and facilities for drainage, and as both materials are easy to handle and settle well to form a good surface in station yards and sidings where shunting operations are carried out, they are very suitable for these locations.

The best ballast is not necessarily the most suitable for all conditions.

On newly formed banks of impermeable soil, such as clay, black cotton soil, blue shale etc., not only will heavy settlement take place in wet weather, but the bank will tend to become spongy and absorb the ballast rapidly. In such cases the initial provision of metal ballast is not only wasteful but injurious, as it will disappear into the formation under the impact of traffic.

Punching of metal ballast into a soft formation results in water pockets being formed from which the water has no escape. In these cases ashes, sand, or fine clean gravel are the best ballasts to use as they mix with the clay and render it porous and thus enable it to be drained.

The depth of ballast has an important bearing on the distribution of the weight of traffic on the formation, and the practice today is to increase the depth of ballast when re-conditioning tracks.

Sub-ballast of ashes or gravel is much in use on some railways and serves the purpose of a cheaper and equally efficient base for the ballast bed.

The additional thickness of ballast ensures good drainage of the track to a greater depth than is possible with ordinary ballasted track.

Under the influence of traffic and weather conditions, coupled with the ingress of dust and dirt, all ballast eventually settles into a solid and more or less impervious mass. Ballast which has become foul in this way retains the water on the formation, and in this condition is described as foul ballast.

The importance of good and sufficient ballast is now widely recognised, since ballast is to the track what foundations are to a house. It forms the support for the track structure, which in turn carries the weight of the traffic.

ACIDITY

The acidic conditions of certain gravel and sand ballasts will, in the presence of moisture, rapidly corrode the rail flanges and, where this action is in evidence, the ballast must be kept clear of the rails.

If doubt exists as to the suitability of the ballast, the matter should be reported to enable tests to be made.

SLEEPERS. 8.

PURPOSE

The purpose of the sleepers is primarily : -

- (a) To properly support the rails.
- (b) To provide a means of keeping the rails to gauge.

In transmitting and distributing the weight of traffic to the ballast, the sleepers are subjected to severe compression and bending stresses at the rail seat. Twisting and bending stresses occur due to the irregularity of packing, or imperfect rail seating, and to the application of anchors to control creep etc.

Impact, abrasion, the effects of weather, acids in the ballast and damage by fire are factors tending to the destruction of materials used for sleepers. The application of the rail fastenings at the rail seat further tend to reduce the strength of the sleeper at this most important location and to promote its destruction by the ingress of water and abrasives.

Many materials have been tested to determine the most satisfactory sleeper, having regard to cost and available supplies.

STEEL SLEEPERS

Tests have been conducted in Victoria with steel sleepers of various sections pressed from steel plate or fabricated from rolled sections, and the test sleepers installed in 1916 are still in service.

Types of steel sleepers at present under tests in track are shown in Figs. 1, 2, 3, & 4.

Under good conditions very satisfactory service is obtainable from steel sleepers, but objections to their general use are : -

- (1) High first cost.
- (2) Difficulty in the adjustment and renewal of rail fastenings.
- (3) Difficulty in properly packing the hollow pressed sleepers.

- (4) Corrosion in acid ballast.
- (5) Insulation in electrified tracks.
- (6) Noise.
- (7) The pressed sections are difficult to repair if damaged in service.

CONCRETE SLEEPERS

Concrete sleepers are less satisfactory than steel sleepers owing to their weight and liability to crack in handling and in service. The chief objections to the use of concrete sleepers are : -

- (1) High first cost.
- (2) Excessive weight if made of ample size.
- (3) Difficulty in the adjustment and renewal of rail fastenings.
- (4) Corrosion of the reinforcing bars by the ingress of water through service cracks.

A small number of concrete sleepers are under test in track and the principle features of these sleepers are shown in Fig. 5.

CAST IRON POT SLEEPERS

In India the rails are laid in some tracks on cast iron pots, and the rails are held to gauge by steel spacing bars.

TIMBER SLEEPERS

Timber sleepers of the hardwood varieties, native in Victoria, have proved very satisfactory for service conditions, and these are the sleepers in general use.

The properties required in timber sleepers are : -

- (a) Toughness to withstand bending and permit of spiking without splitting.
- (b) Strength to carry the load at the rail seat without crushing.
- (c) Resilience to deflect with the formation without breaking.
- (d) Durability to weather well and to resist decay and the ravages of white ants.

The most suitable varieties of timbers are Red Gum, Red Ironbark, Red Box, Yellow Box, Grey Box, Yellow Stringybark, Yellow Gum, White Stringybark and Yertchuk.

Sleepers cut from matured trees are the best as the timber from young trees has not the wear resisting qualities of the older timber.

SLEEPER LIFE

With the better classes of timbers the life of the sleeper is usually dependent upon mechanical conditions such as rail cutting and spike killing with ultimate failure due to breaking through at the rail seat.

The service life of timber sleepers varies according to the class of timber, the location and conditions of service.

Factors contributing to the destruction of timber sleepers, are : -

- (a) Rail cutting.
- (b) Spike killing.
- (c) Breakage.
- (d) Splitting.
- (e) Fire.
- (f) Decay.

RAIL CUT SLEEPERS

Rail cutting occurs at the surface of contact between the rail and the sleeper, and is brought about by crushing and wearing away the surface of the sleeper. The condition is caused by movement between the rail and the sleeper, and is aggravated by the ingress of sand and grit which grind away the timber fibre, particularly when softened by the presence of water.

Rail cutting is a mechanical failure which can be retarded by adzing away the surface timber adjacent to the rail flange and re-driving the dogspikes to hold the rail firmly to the sleeper, and thereby reducing the relative movement and the abrasive action.

SPIKE KILLED SLEEPERS

Spike killed sleepers result from driving dogspikes in new positions at the edge of the rail flange, thereby reducing the section of the sleeper at this position. The fibres between spike holes are crushed and fail to grip dogspikes driven adjacent thereto.

BROKEN SLEEPERS

Broken sleepers result from an unequal distribution of sleeper loading owing to improper support of the sleeper on its bed, and may be caused by subsidence of the formation or by faulty packing.

Experience has shown that uniform packing is necessary from the ends of sleepers to a position 15 inches inside the gauge. See 3.04.

Sleepers which have been weakened by rail cutting and spike killing will break under the rail if not uniformly packed.

SPLIT SLEEPERS

Straight grained timber sleepers may be split when the dogspikes are driven if the auger holes are too small for the dogspikes, or if the dogspikes are driven in line, particularly when seasoning cracks are present in the timber.

DESTRUCTION BY FIRE.

No satisfactory means has as yet been developed at reasonable cost to prevent the destruction by fire of timber sleepers, but the danger from fire can be reduced by removal of dry grass and debris adjacent to the sleepers.

Timber can only be ignited by raising its temperature to ignition point, and this can take place more readily with small splinters than with a mass of solid timber. Shattered fibre and splintered edges caused by careless use of tools and equipment increase the hazard of fire.

Burning sleepers can be effectively extinguished by smothering the fire with earth if water is not readily available. Water should not be thrown on a heated rail for reasons set out in 9.10.

DECAY

Decay is caused by the activities of a low form of plant life called bacteria and fungi. These organisms are exceedingly small and the seed of the fungi, which is fine like dust, is readily carried by the wind.

Warmth, moisture and oxygen are necessary for the germination of the seeds, and after germination, food is of course necessary for their development. If one or more of the necessities of life can be kept from the fungi, it cannot live.

It is not ordinarily practicable to exclude warmth and the oxygen contained in the air, but moisture can be reduced to a minimum by proper drainage, by the elimination of weeds and other vegetable growth in the ballast, and by the provision of a quick getaway for water in cuttings.

PRESERVATION

Immature and inferior timbers subject to decay are treated by a process of chemical penetration.

In the past the timbers available have for the most part been of such quality that satisfactory service has been obtained without the necessity of chemical preservation. If the life of timber under the effects of decay exceeds the life by reason of fibre crushing and spike killing at the rail seat, there is no advantage in chemical preservation.

It is, however, quite evident that inferior timbers will be more in use as the better classes become increasingly scarce, and tests are at present being conducted with the following varieties of the less durable timbers : -

River Red Gum, Mountain Grey Gum, Silver Top Ash, Yellow Stringybark, Manna Gum, Messmate, White Stringybark and Coast Grey Box.

CHEMICAL PRESERVATION

Chemical preservation is usually effected at a suitable treatment plant, and the treated timbers are delivered ready for installation in the track.

The process varies according to the class of timber and its condition of seasoning, but in general it is necessary to penetrate the surface of the timber to some depth to ensure the best results, and this may be done by immersion or under pressure in a sealed chamber.

In the present tests the preservative used is a mixture of creosote 80 parts and crude petroleum oil 20 parts, which is sprayed on all surfaces of the sleeper and on the sleeper beds before placing sleepers in the track. After laying, a further spray treatment is given to the top and sides of the sleeper, and all spike or screw holes are treated with the preservative before driving the fastenings.

As sleeper plates are being used in the present tests adzing is not required, but if treated sleepers were adzed it would be necessary to treat the adzed surfaces with preservative before laying in track.

MECHANICAL PRESERVATION

The life of timber sleepers is considerably lengthened by affording mechanical protection to the sleeper at the rail seat. Sleeper plates are now installed in all main tracks during re-laying or re-sleeping, and by their use the load on the rail is distributed over a larger area of the sleeper surface, thus reducing the destruction of the fibres beneath the rail.

The frequency of re-spiking is also reduced, as the inside dogspike contributes to the support of the rail against lateral thrust, and the additional plate dogspikes used in double shoulder sleeper plates further assist in opposing the lateral thrust.

Bolts or crinkle metal straps at the end of straight grained timber sleepers preventsplitting when the spikes are driven, or under service conditions.

If the bolts or straps are made of iron, they are slow to corrode and usually outlast the sleeper. Some Red Ironbark sleepers recently removed from the station pit at Chewton had been rivetted at the ends with $\frac{1}{2}$ " diameter wrought iron rods which were in good condition after 47 years service.

CLASSIFICATION

Two classes of new sleepers are provided according to the service required, rectangular and round top, the general length being 9'0" for 5'3" gauge and 5'6" for 2'6" gauge.

Rectangular sleepers are 10"x5" hewn from mature timber, straight and out of wind, to full dimensions with square angles.

Round top sleepers are cut from Grey Box, Red Ironbark, Red Gum, Red Box, Yellow Box, and Yellow Gum timbers only, to 10" width on the bottom with square base angles and sides not less than $3\frac{1}{2}$ ". Sufficient Truwood at the rail seats is required to provide a 5" width of rail bearing surface, as shown in Fig. 6.

The locality in which the timber is grown has a considerable influence on the quality of the timber, and longer service is generally obtained from timbers used in the locality in which they are grown.

Timber sleepers are now classified as new, serviceable, and unserviceable. Unserviceable sleepers are further classified as suitable for fencing posts, or as debris.

STACKING

New sleepers must be stacked with the heart side down to season the timber and prevent warping. Three unserviceable sleepers must be placed three feet apart on the level ground to form a base for the stack. Unless space is restricted, the stack should not be more than six tiers high, and the two top tiers must be sloped to form a roof as shown in Fig. 7.

ADZING

When sleepers are adzed for the 1 in 20 rail inclination the adzing must be the full width of the rail flange, true and even across the sleeper. Adzing must be marked and tested with the templates provided for the purpose.

Extra width of adzing is required at joint sleepers when angle fishplates are in use, and a special template is provided for this purpose.

When necessary the surface of the sleepers must be adzed to correct for wind, and be marked for boring and tested for seating of sleeper plates; special templates are provided for this purpose. See 15.05.

BORING

Holes for dogspikes are bored right through the sleepers to prevent bursting out the bottom of the sleeper.

Every hole for $\frac{3}{4}$ " square dogspikes must be bored with $\frac{3}{4}$ " auger, and for $\frac{5}{8}$ " square dogspikes, with a $\frac{5}{8}$ " auger. When $\frac{3}{4}$ " round dogspikes are used, every hole must be bored with an $11/16$ " auger.

Holes for creep pins are bored $1/16$ " smaller than the pin size, one hole at each rail end, two pins per rail. See Fig. 8.

When the sleepers are adzed at an inclination of 1 in 20 to fasten the rail direct to the sleeper, the centre of each hole must be bored $2\frac{3}{4}$ " from the edge of intermediate sleepers.

The two inside and the two outside dogspikes must be located on opposite sides of the centre of intermediate sleepers on the straight. The two outside dogspikes must lead in the direction of traffic on double track, and down hill in single track.

On curves of 25 chains radius or less, two dogspikes must be used on the outside of the outer rail at $2\frac{3}{4}$ " from the edge of intermediate sleepers, and the inside dogspike must be in the centre of the sleeper.

At joint sleepers the dogspikes are located in the notches provided in angle fishplates, or the holes provided in special joint plates.

The arrangement of dogspikes for unplated straight and for unplated curved tracks of 25 chains radius or less, is shown in Figs. 9 and 10. The arrangement of dogspikes for plated tracks is shown in Fig. 11, 8.13-8.15.

The boring for sleeper plates is marked off from the same template used in testing for wind; spot holes are provided in the template for the purpose of marking the positions for boring. It should be noted that if the template is correct, the gauge of the track will be correct within the tolerance allowed.

On construction work when large numbers of sleepers are required "Adzing and Boring machines" are used, and the work is much more accurately performed than is possible by hand.

GENERAL

Sleepers are laid at right angles to the track, and in square jointed track the joints should be in line to avoid skewing of the timbers for spiking purposes. On curves the gain in the joint position will not permit of spiking in slots of angle fishplates without slightly skewing the joint sleepers or boring too close to the edge of the sleepers.

The maximum allowable gain or loss in joint position is $1/2$ the space between fishbolt holes, and the skew therefore should never exceed $2\frac{1}{2}$ " for Australian Standard rails. The boring in these circumstances may be at any point across the sleeper but not closer than 2" from the edge.

Sleepers are laid in track with the heart side down as the heart wood is the less able to withstand the effects of weather; the open grain in this face would, if laid upwards, retain water and rapidly develop decay.

In placing sleepers in position considerable damage may be done to the sleepers if the points of picks and bars are driven into the sleepers to assist in getting them into position.

Damage will also be done to the sleepers if, in squaring them to position and spacing, the light small faced spiking hammers are used; if a hammer is used, it should be a heavy broad faced hammer. A heavy hammer has a less damaging effect on timber fibre, as the blow has somewhat the effect of a pushing action.

The use of timber hooks of the pattern shown in Fig.12, is preferable for the movement of timbers to their required positions, as shown in Fig.13.

Temporary or incorrectly bored dogspike holes should be plugged with wooden plugs to avoid water getting into the sleepers and promoting decay.

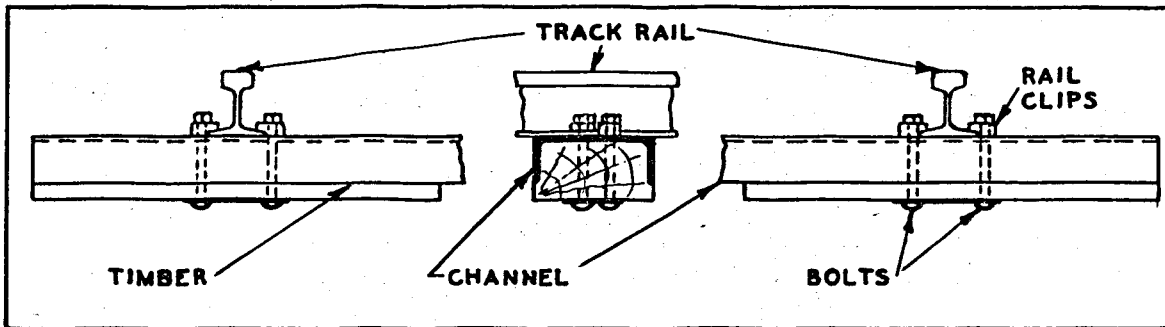

FIG. 1. STEEL CHANNEL AND TIMBER SLEEPER

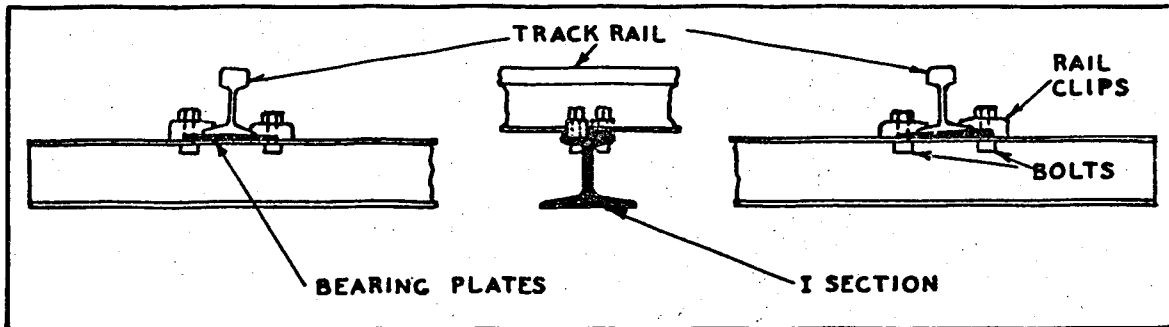

FIG. 2. CARNEGIE I SECTION STEEL SLEEPER

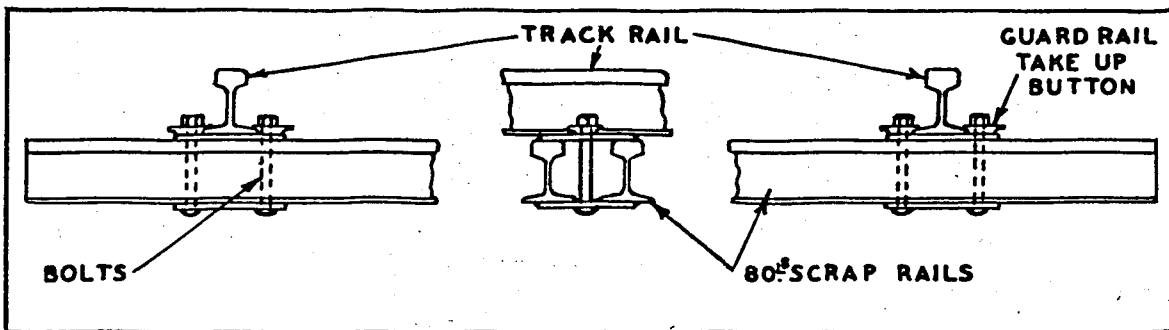

FIG. 3. STEEL SLEEPERS FOR ASH DUMPS

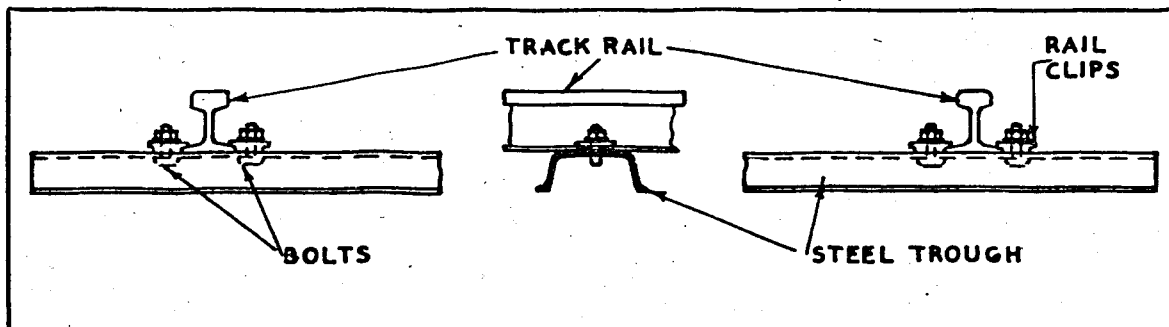

FIG. 4. TROUGH STEEL SLEEPER

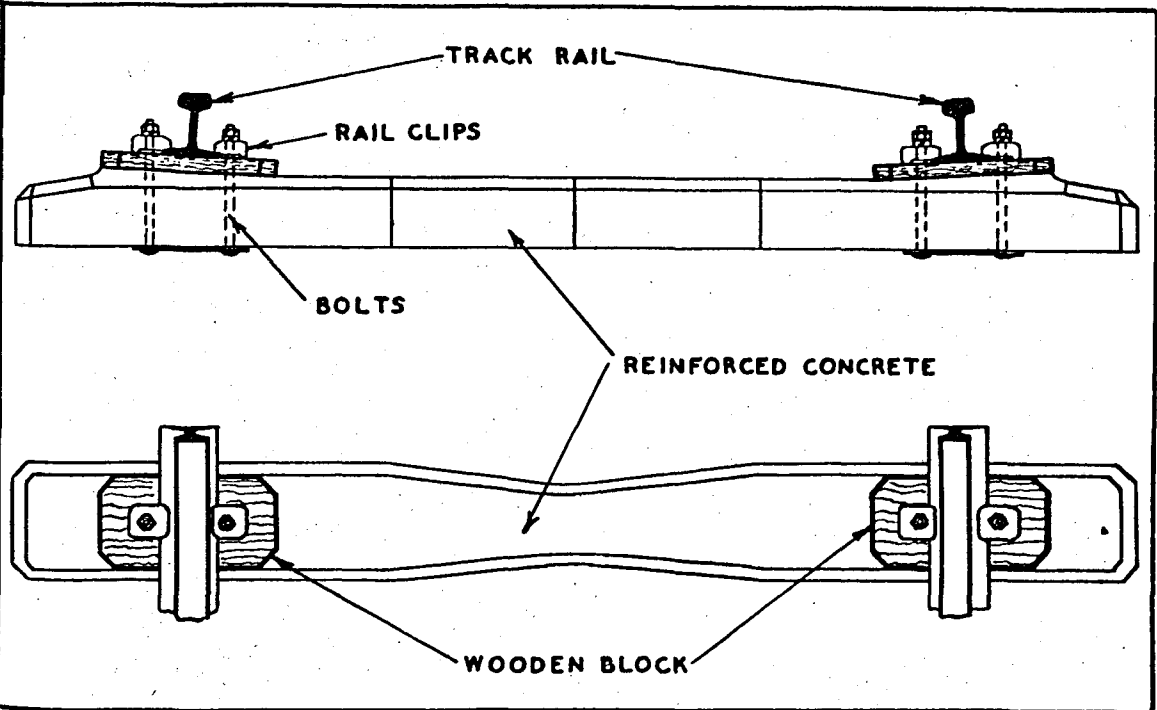

FIG. 5. REINFORCED CONCRETE SLEEPER

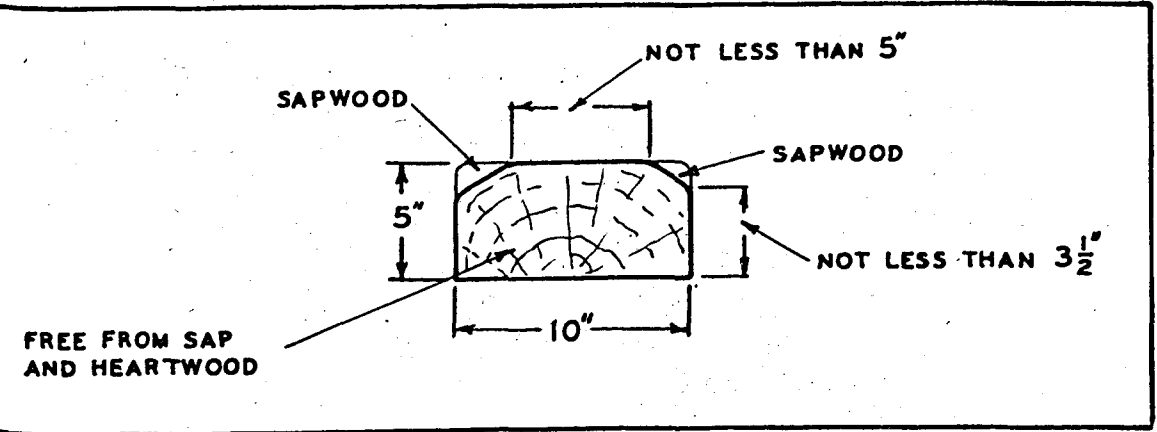

FIG. 6 ROUND TOP SLEEPER SPECIFICATION

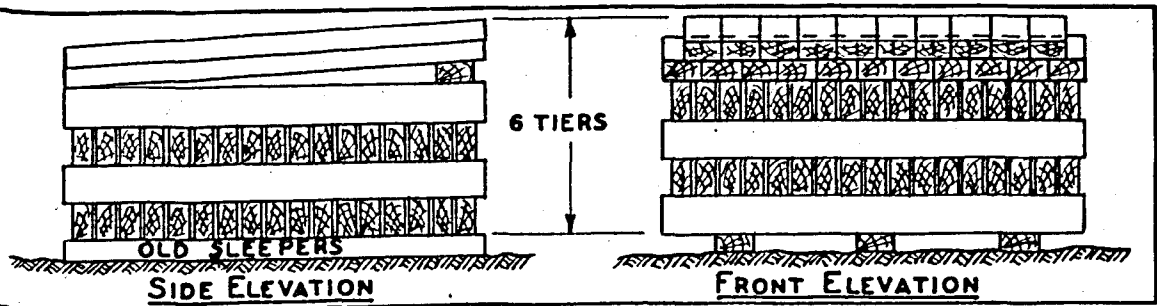

FIG. 7. SLEEPER STACK

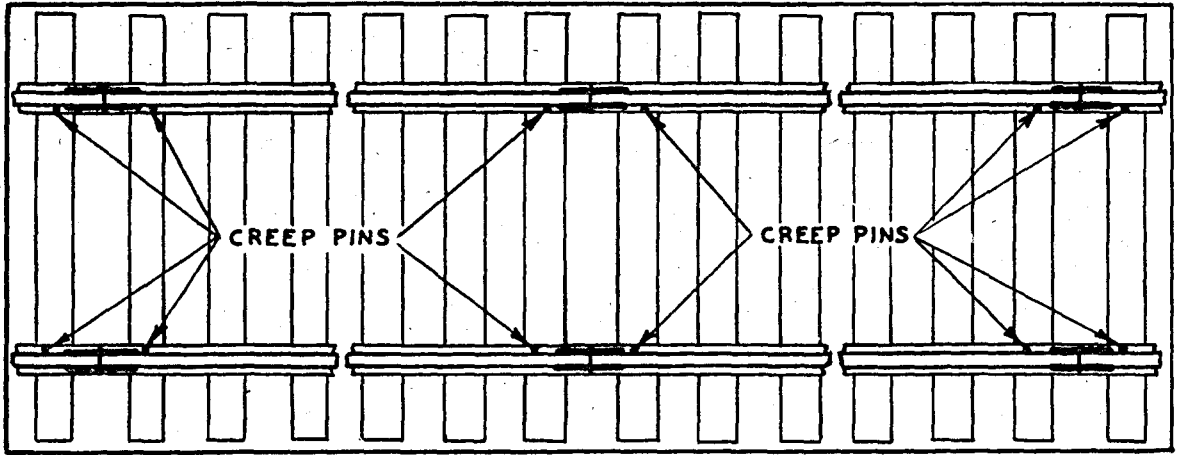

FIG. 8. POSITION OF CREEP PINS

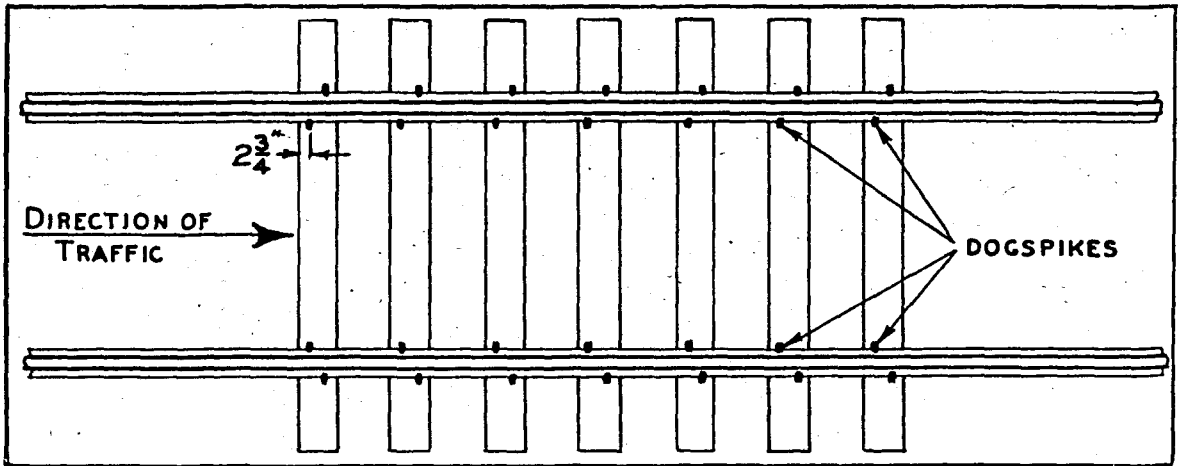

FIG. 9. DOGSPIKING ON DOUBLE TRACK & DOWN HILL ON SINGLE TRACK

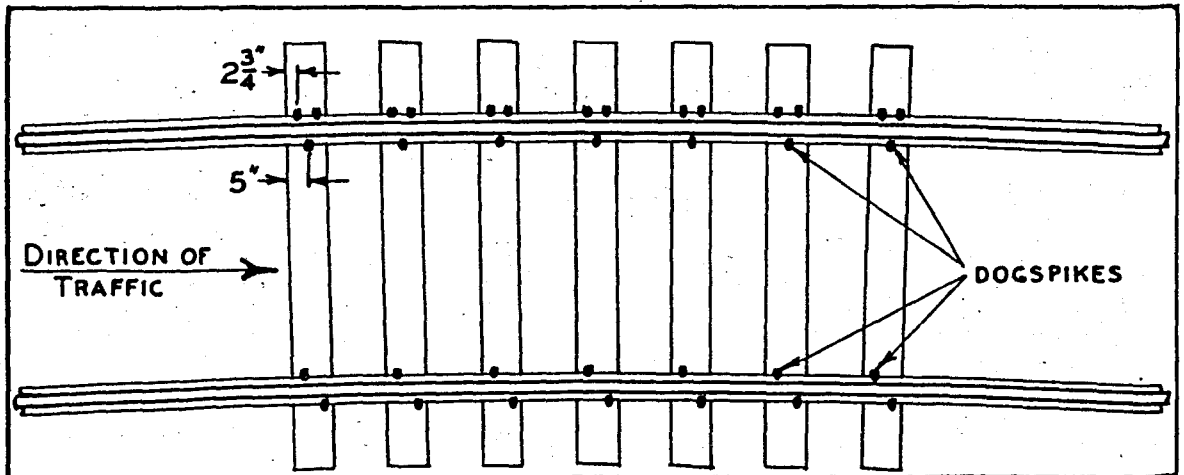
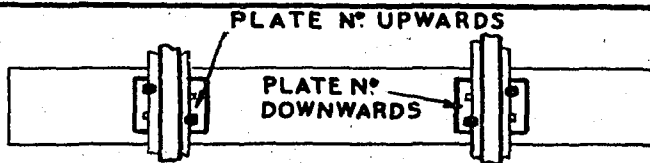
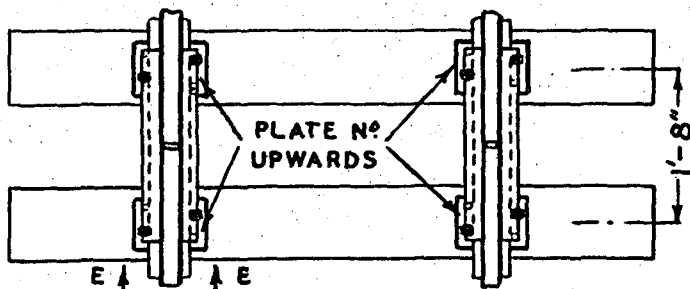

FIG. 10. DOGSPIKING ON CURVE OF 25 CHAINS OR UNDER



INTERMEDIATE SLEEPERS

94 & 107 LB.



**RAIL JOINT
ANGLE FISHPLATES**

94 LB.

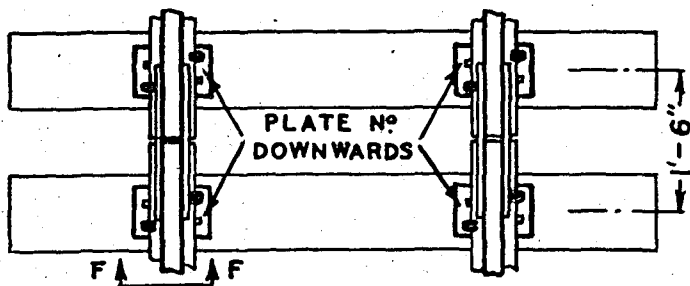

**RAIL JOINT
BAR FISHPLATES**

94 & 107 LB.

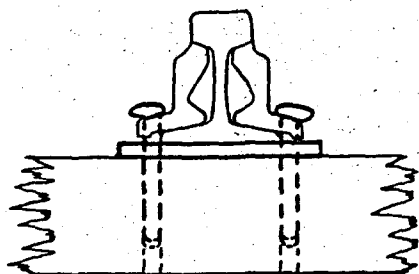

SECTION EE.

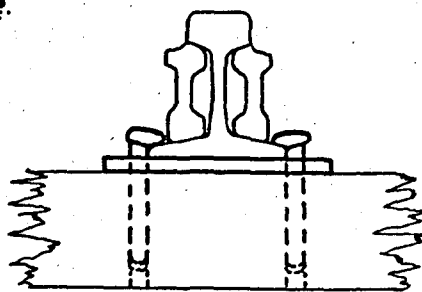

SECTION FF

APPLICATION OF FLAT SLEEPER PLATES

FIG.II. ARRANGEMENT OF DOGSPIKES WITH SLEEPER PLATES

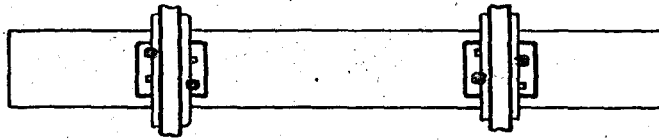

INTERMEDIATE SLEEPERS
94 & 107 LB.

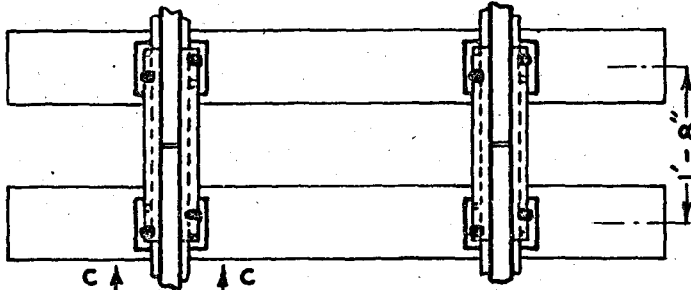

RAIL JOINT
ANGLE FISHPLATES
94 LB.

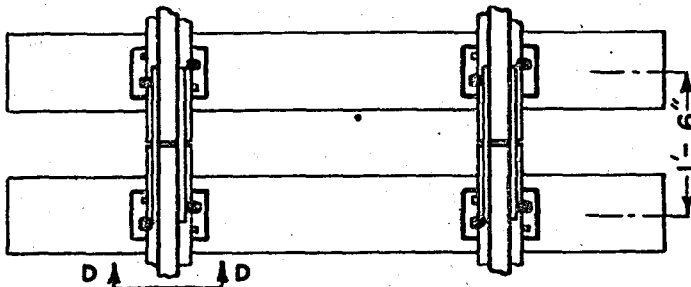

RAIL JOINT
BAR FISHPLATES
94 & 107 LB.

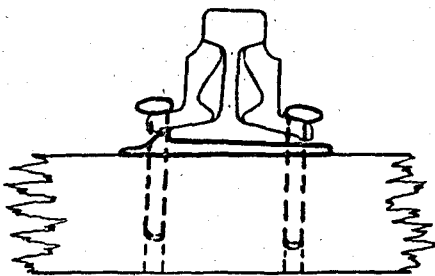

SECTION CC

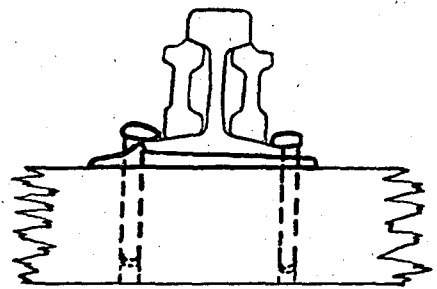

SECTION DD

APPLICATION OF SINGLE SHOULDER A.S. SLEEPER PLATES

FIG. II. ARRANGEMENT OF DOGSPIKES WITH SLEEPER PLATES

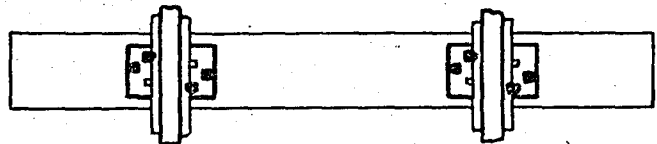

INTERMEDIATE SLEEPERS
94 & 107 LB

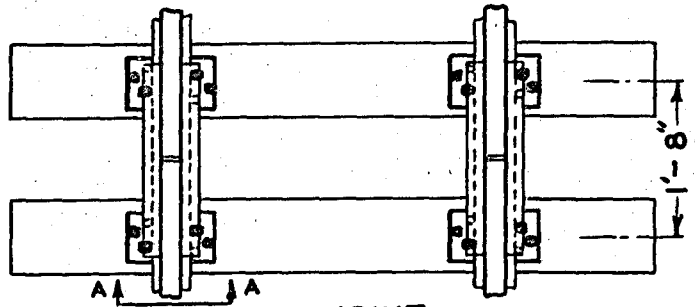

RAIL JOINT
ANGLE FISHPLATES
94 LB

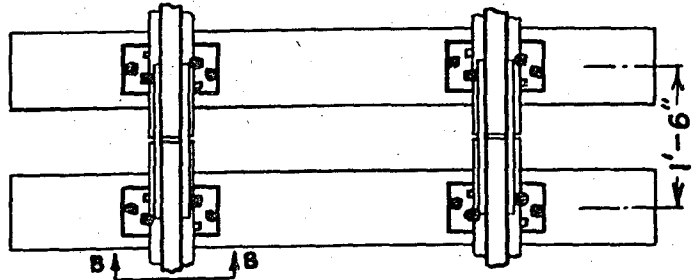

RAIL JOINT
BAR FISHPLATES
94 & 107 LB

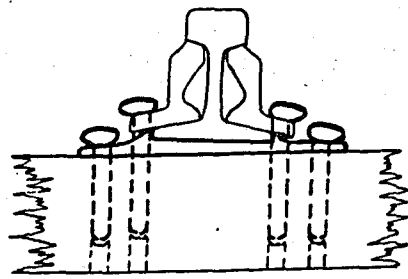

SECTION AA

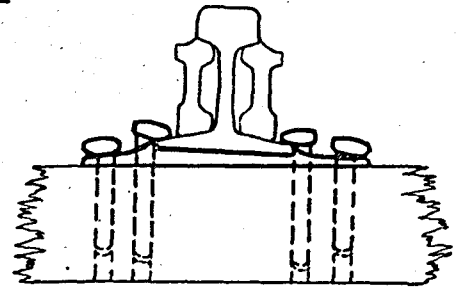

SECTION BB

APPLICATION OF DOUBLE SHOULDER A.S. SLEEPER PLATES

FIG. II. ARRANGEMENT OF DOGSPIKES WITH SLEEPER PLATES

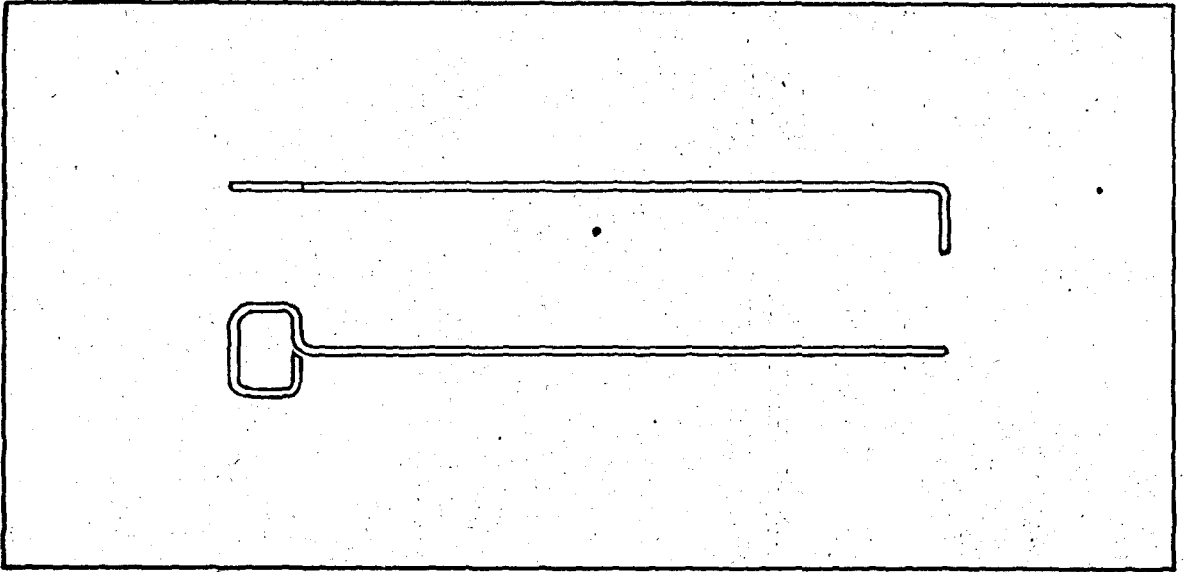

FIG. 12. THE TIMBER HOOK

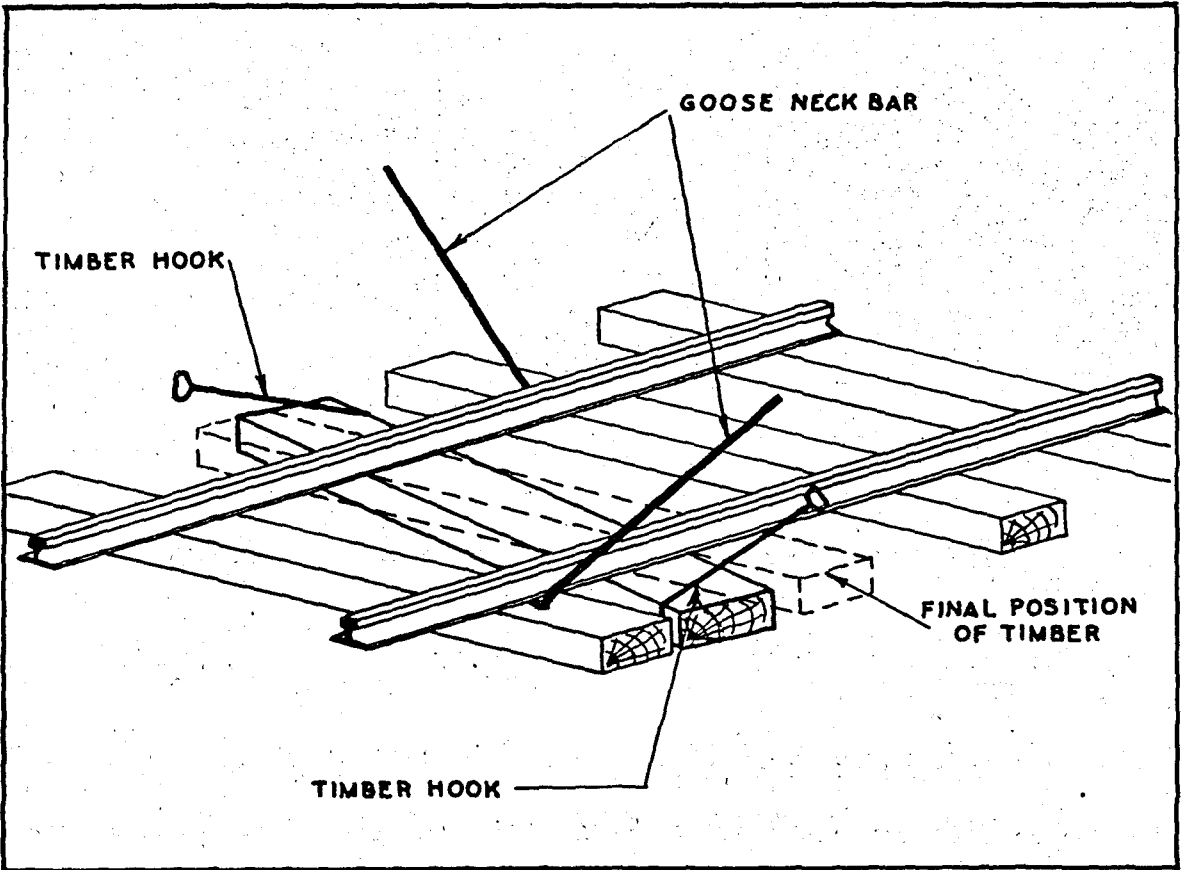

FIG. 13. USE OF TIMBER HOOKS

RAILS. 9.

PURPOSE

The purpose of the rails is : -

- (a) To provide a path to carry railway traffic without undue resistance.
- (b) In conjunction with the wheel flanges to direct the course of traffic.

QUALITIES

To serve this purpose rails require to be possessed of the following qualities : -

- (1) Rigidity to enable the rail to carry the load without undue deflection or permanent deformation.
- (2) Strength to withstand the stresses imposed upon the rails under service conditions.
- (3) Durability to prolong the service life of the rail in conformity with its cost.

The rigidity and strength of the rail depend upon its section and rails of larger section are used where service conditions are severe.

Durability depends chiefly upon the qualities of the material as influenced by its chemical composition and process of manufacture.

Carbon steel possesses the necessary properties of hardness, toughness and resilience.

Hardness is a necessary property to withstand wear.

Toughness contributes to the strength of the rail.

Resilience enables the rail to regain its normal shape and condition after the passage of the load.

All the foregoing properties are possessed to a greater extent by steel than by iron.

TYPES OF RAILS

From the various types of rails used during the development of railways three distinct types of rolled sections have been standardised : -

- (1) The 'flat bottom' or 'T' rail, which is the Australian Standard, is in general use in most countries.
- (2) The 'bull headed' (a development of the earlier 'double headed') rail used on the British Railways.
- (3) The 'grooved girder' rail used for tramways.

All three types are in use in Victoria for railway and tramway work but the 'double headed' rail remaining in service is now mostly to be found in sidings.

IRON RAILS

The earlier rails were of iron and were light rails, the sections in use in Victoria being as follows : -

Nominal weight per yard lbs.	Classification Letter	Type
50	A	Flat bottom
60	C	" "
72	J	Double headed
75	G	Flat bottom
75	L	Double headed
80	K	" "

In the days of iron rails it was the practice to refer to the rails and fastenings as iron and ironwork.

STEEL RAILS

Steel rails were first introduced in 1862, but because of the high cost of production compared with iron rails, the latter continued to be rolled for some years after the development of steel rails.

The earlier types of steel rail were obtained from overseas, but the bulk of the rails purchased since 1916 have been Australian rolled. Some special steel rails have been imported in recent years for comparative tests, but in several instances similar rails are now obtainable of Australian manufacture. The steel rails in use in Victoria are as follows.

STEEL RAILS

Nominal weight per yard lbs.	Classification Letter	T y p e
50	B	Flat bottom
60	C, D, N and AS	" "
60	N.S.W. & Sec. 602	" "
61	S.A.	" "
66	E and F	" "
72	J	Double headed
75	H and I	Flat bottom
75	L	Double headed
80	K	" "
80	O and AS	Flat bottom
90	AS	" "
94	AS	" "
100	M, P, AS and BS	" "
107	AS	" "
110	AS	" "

SPECIAL TYPES

For the construction of points and crossings special heavy sections with a thick web have been used as follows : -

Nominal weight per yard lbs. Heavy section	Equivalent weight per yard lbs. Light section	Material	T y p e
57	50 B	Steel	Flat bottom
70	60 C	Iron & Steel	" "
78	66 E	Steel	" "
86	75 H	"	" "
95	80 O	"	" "
115	100 P	"	" "

In some cases these special heavy sections were laid as track rails with the heavy fishplate on the running edge side of the rail.

TRAMWAY RAILS

The rails in use on the St. Kilda to Brighton and Sandringham to Black Rock Electric Street Railways are 90, 92, 96 and 102 lbs. tramway rails, the 92 lb. section predominating.

DIMENSIONS

The principal dimensions of all rails in present use, together with the approximate year of introduction, are set out in Tables 9.20-9.25 and Figs. 1 to 20.

SECTION

Section is the term used to define the outline or shape of the rail and the section of flat bottom rails is considered as consisting of three portions known as the 'head', the 'web', and the 'flange'.

The underside of the head and the top of the flange are sloped to form the 'fishing surfaces' and the angle between the fishing surfaces is described as the 'fishing angle', the fishing surfaces join the web by curves known as fillets. See Fig. 21.

The top surface of the rail head on which the wheels roll is the 'running surface' and the side of the rail head in contact with the wheel flanges is the 'running edge'.

WEIGHT

Rails are described by the nominal weight per yard of length, but the actual weight is usually slightly different from the nominal weight. See 20.45.

LENGTH

The earlier rails were obtained in short lengths because of the difficulties of manufacture and transport.

Manufacturing difficulties have been largely overcome and rails are now rolled in Australia up to 300' long, but for transport reasons are cut to a maximum length of 45'. Defects in rolling occasionally necessitate cutting the rails shorter than 45'0", and as short rails are required for closure purposes a percentage of 30', 35' and 40' lengths are acceptable under rail contracts.

Special length rails were purchased in the past for the manufacture of points and crossings and for the short rail required in the inner rail of curves. With the installation of the Flash Butt welding depot the necessity for purchase of special rail lengths has been obviated as short ends cut from standard rails are now used in the ordinary course of welding.

The lengths of rails of the various sections in use in Victoria are shown in Tables 9.20-9.25.

TOLERANCES

As rails are rolled while hot and in a plastic condition certain allowances are provided for inaccuracies in rolling and the amounts by which the rail may vary from the true section are described as tolerances.

The tolerances permitted by the Australian Standard Specification are as follows : -

A variation of a $1/64$ inch less or $1/32$ inch greater height and $1/16$ inch in the width of the flange.

A variation of $1/32$ inch in size or position of fish-bolt holes and of $1/4$ inch in the length of the rails when measured at 62°F .

A fishplate template inserted in the fishing angle of the rail shall not be displaced outwards more than $1/16$ inch from its intended position.

RAIL BRANDS

Each rail of the Australian Standard is branded with raised letters and figures indicating the year of adoption as standard, the letters A.S. (signifying Australian Standard), the nominal weight per yard, manufacturer's name or initials, and the month and year of rolling, also the process of manufacture.

Thus a rail branded AS 94 (1937) AIS 111/1940 OH indicates, though not in this order, 94 lbs. 1937 Australian Standard rail, manufactured by the Australian Iron and Steel Co., in March 1940 by the Open Hearth process.

Manganese rails are branded in full, Medium Manganese MMN, Chromium CR, Silicon SI, High Silicon HSI, etc.

HEAT NUMBERS

Several letters and numbers are stamped into the web at one end of each rail clear of the fishplate positions indicating the number of the cast, the ingot number, and the letters indicating the furnace and the portion of the ingot from which the rail was made.

For example C 963 A 17 indicates that the rail was rolled from number 963 cast from C furnace and was the A rail cut from number 17 ingot.

Particulars of rolling brands and heat numbers are required to be shown on all reports of defective rails when found in main track and it is from these particulars that the rail is identified with the Department's records of tests and chemical analysis of rails; it is therefore of the utmost importance that these particulars be noted with accuracy when furnishing such reports.

Heat numbers may not be found on some rails from other countries, but they always carry rolling brands and these must be fully recorded on the reports.

RAIL JOINTS

For convenience of classification rail joints are described as : -

- (1) Mechanical joints comprising standard fishplate joints, junction joints and insulated joints of which particulars are given in 10.03-10.07.
- (2) Welded joints of which the Flash Butt is now the standard type, Thermit joints used for welding rails in track, and a number of experimental Electrode and Gas Welded joints used during the development of welded rails.

Because of the form of some of the welds and the necessity of suitably arranging the sleepers relative to the welds, the term welded joint has been used, but in respect to Flash Butt welds the continuity of rail is restored by welding and the position of the weld is adequately described by the term 'weld'.

WELDED RAIL

The rail joint is the weakest element and the most costly to maintain in track. It has been much improved and is capable of further improvement both in design and in methods of maintenance, but as speed and weight of traffic are constantly increasing it is doubtful that the ideal joint will ever be evolved. See 10.03-10.04.

In these circumstances the reduction of the number of joints necessary in track is a considerable advance towards the solution of better riding and cheaper maintenance of track.

Welding of rails at the joints in track has been in use on tramways for many years, the process employed being the Thermit weld. In tramway tracks the rails are restrained in position by the surrounding road materials and difficulties with regard to expansion are not troublesome.

Research on the subject of restraint of the rails against the forces produced by expansion led to the development of the welded railway track in which the rails are restrained by the use of rail anchors and a heavily ballasted track structure.

Thermit welding of railway track rails was first undertaken in Victoria on the St. Kilda tracks in 1931 and is used for welding rails in position in track.

In 1936 Flash Butt welding was commenced at the Spotswood Permanent Way Depot and being much cheaper than Thermit has replaced this process for general welding purposes.

The general length of Flash Butt welded rail supplied was as follows : -

Weight	Length	Purpose
90 & 110 lbs	225'	Straight & curved track over 60 chns rad.
" "	180'	Curved track 40 to 60 chains rad.
" "	135'	" " 30 40 " "
" "	110'	" " 20 30 " "
" "	90'	" " 15 20 " "

Since 1938 the general length of welded rail supplied has been as follows : -

Weight	Length	Purpose
90 to 110 lbs	270'	Straight & curved tracks over 20 chns rad
	90'	Curved tracks under 20 chains rad.

Light rails are welded to serviceable lengths as follows : -

Weight	Length	Purpose
80 lb.	180'	General, subject to approval for location
75 lb.	103'	" " " "
60 lb.	80'	" " " "

Because of insulated joints, bridges and station yards, and condition of traction and braking on grades, the length and arrangement of long welded new rails will frequently vary from the above table and the actual lengths to be laid are determined by the Chief Civil Engineer.

A loss of $\frac{3}{4}$ " to $\frac{7}{8}$ " in rail length occurs at each Flash Butt weld and when new rails are welded the overall length varies according to the welding loss and the tolerance on the rail lengths as purchased, so that the difference in length per weld may be as much as $1\frac{1}{8}$ ".

Serviceable rail is frequently cropped at the ends to remove that portion of rail damaged by joint conditions and some welded lengths have been designed to make allowance for this cropping.

For closures of known length the welded rails are supplied cut and bored as required, but for level crossings and other rails where the length cannot always be fixed before the job is in hand, the welded rails are supplied with one blank end to cut and bore as required.

THERMIT WELDS

Two methods of Thermit welding have been used, the Combined and the Fusion. The Combined weld was first introduced and many welds made by this process are in track, but the Fusion weld is the process now used.

Thermit welds are effected by the combustion and chemical re-action in a crucible of a mixture known as Thermit which, on ignition, rapidly reduces to its molten state and is then run into a mould surrounding the rail ends.

COMBINED WELD

In the Combined weld the rail ends are aligned in clamps, the ends are prepared and a pure iron insert is calked between the rail heads, the mould is then fixed to encase the rail ends which are pre-heated before the Thermit is ignited.

After the molten metal has been run into the mould the clamps are tightened to complete the weld and sufficient time is allowed for the metal to solidify before removing the mould. The weld is roughly dressed to remove slag and unwanted protrusions and then allowed to cool before chipping and filing the running surface and sides of the rail heads.

When completed the Combined weld appears as in Fig. 22.

FUSION WELD

Much less work is involved with the Fusion weld as no special preparation of the rail ends is required other than brushing away rust and scale. The space between the rail ends is adjusted to receive the weld metal and rail anchors are applied to hold the rail in position during welding, the rail ends are then brought into alignment by dogspikes and wedges and encased in the mould.

After the rail ends are pre-heated in the mould the Thermit is ignited and the metal run into the mould to effect the weld. On solidification the mould is stripped, the excess metal is removed from the weld at the running surface by means of hot sates, and unwanted protusions are dressed off.

Chipping and filing of the running surface and sides are carried out after the rail has cooled and the completed weld appears as in Fig. 23.

FLASH BUTT WELD

The Flash Butt weld is effected between the ends of the rails without a special preparation or the addition of other metal.

The process consists of melting the rail ends by means of an electric arc intermittently struck between the ends of the rails and when in a suitable plastic state forcing the rail ends together to effect the weld.

Flash Butt welds are made by an automatic welding machine at the Spotswood Permanent Way Depot and the long welded rails are trucked on several bolster trucks to their destination.

During transport the rails readily conform to the curves followed by the train. Loading at the Depot is done by sliding the rails down an inclined platform on to the trucks, and discharge at the point of laying may be effected by rail skids from the side of the trucks, or when space does not permit of the use of skids, as in cuttings, etc., the rail may be lowered from the truck sides by chains.

In restricted areas such as through tunnels, at bridges and in cuttings, it is not always convenient to discharge the rail at the point of use, and trolley wheels and axles are used to move the rail into position, or in the case of long lengths through tunnels, the length is drawn in by a locomotive.

When trolley wheels and axles are used, the rail should be supported as nearly as practicable to one or other of the wheels, and not in the centre of the axle; the correct method is shown in Fig. 24. For details of the rail hanger and the rail lifting lever see 15.05.

RAIL STEEL

The subject of rail steel goes very far beyond the scope of these papers, but the following short description of this material is given to inform trackmen of the nature and properties of the steel which they are daily handling in service.

There are many grades of steel, the most usual met with being carbon steel, but other special alloy steels are in use in modern trackwork.

If a piece of steel is broken and its surface examined, it will have the appearance of a rough granular substance, the grains or crystals varying in size according to the grade and composition of the steel.

If the surface of a piece of steel be carefully prepared for an acid process known as etching, and then the surface be examined through a microscope, a mottled pattern of dark areas surrounded by a lattice of light material is revealed.

The dark areas are carbide of iron, hard and brittle, and the larger these areas are the harder and more brittle the steel will be; the white areas consist of ferrite iron which is soft and flexible.

In ordinary mild steel the grains are very coarse, but if the temperature be gradually raised, the carbide diffuses and spreads, and at a temperature of about 850° centigrade the crystals become uniform and smaller. If the steel is then quenched in water, it will become very hard and will break without much bending.

The critical range of temperature depends on the carbon content of the steel, and with the high carbon Australian Standard rails, definite changes take place in the structure of the steel between 100° and 600° centigrade. When seen in a dark room, the steel at these temperatures is far below red heat, in fact, at 600° centigrade, the colour is a dull brown.

As a typical example of the changes which take place in steel by heat treatment, bending tests made with two bars of steel machined from the head of the same rail show that when a bar is bent at room temperature the extent of bending reaches about 40° before fracture takes place, and the appearance of the fracture is not unlike a broken cake of sugar.

If a second bar is heated to 300° centigrade, or about 3 times the heat of boiling water, and quenched before bending, fracture takes place after the bar has bent to about 28°, and the appearance of the fracture somewhat resembles that of a broken lump of common table salt.

Special alloy steels such as manganese and chromium, have their nature altered at other temperatures according to their composition.

The point to be noted is that in the manufacture of rails and many track fastenings, the steel has been specially heat-treated to develop the required properties for the service expected from it, and the trouble and expense incurred in heat treatment may be entirely wasted if heat is applied to the steel for the purpose of bending or straightening, or otherwise altering the shape and form of the rails and certain fastenings; and, moreover, the change effected may in fact impair the properties of the steel to such an extent as to reduce its useful life, if not to cause actual failure in service.

For these reasons The Department has issued instructions that curving, straightening, etc., of special steel work must be done at atmospheric temperature, and rails etc., which cannot be restored to shape by cold working, are to be returned to the workshops for repair.

Under the action of pressure the grain structure at the surface of steel is compacted and the surface becomes very much harder than the rest of the rail. Within limits this is an advantage, as the rate of wear is thereby reduced. The thickness of this skin of hardened metal seldom exceeds $1/16$ inch and is clearly seen when an old steel rail is broken, as in Fig. 25.

Various alloy steels are in use in the manufacture of rails and fastenings. Such steels are made by the addition of elements to carbon steel during its production and impart various properties to the finished steel after suitable heat treatment. Some, but not all, of these properties are obtainable by special treatment of carbon steels, for example:- the sorbitic rails in which a special treatment of rapid cooling of the rail head only causes a particular change in the structure of the steel on the surface of the rail head; this coating of partially hardened steel is called Sorbite.

Hardening of the rail surface without inducing brittleness has been the aim in the development of special alloy steel rails.

Manganese steel is really a tough steel and this property greatly reduces the tendency to fracture, but the chief purpose of using manganese steel in rails is to reduce the wear on the head of the rails, particularly flange wear on curves.

In service the rolling action of the wheels causes manganese steel to develop a hardness on the surface, which still remains tough. On curves, manganese steel rails are found to last longer than carbon steel rails under similar conditions. They are more costly to purchase and cannot be cut or bored by ordinary hand operated tools.

Other alloy steel rails are in use, but the necessity for special rails on curves has been largely obviated by the introduction of track lubrication. See 3.20 & 16.06.

RAIL DEFECTS

Defects occur in rails during manufacture, transport, laying operations and in service.

At the rolling mills the rails are subjected to tests and inspections to insure, as far as possible, that the rails comply with the rail specifications, but hidden faults only become apparent in service, and trackmen require to be constantly watchful for indications of these faults.

Manufacturing defects comprise : -

PIPED RAILS

Piped rails, in which an area of defective material extends for some length within and usually along the centre line of the rail section.

This defect is due to the inclusion of slag and other impurities associated with the top of the steel ingot from which the rail was rolled.

SPLIT RAILS

Split rails, in which the head of the rail splits and spreads, are shown in Fig. 26.

This defect is usually associated with the conditions of piped rails.

TRANSVERSE FISSURES

Transverse Fissures are internal cracks within the steel which originate during manufacture, either in rolling or in after treatment of the rail.

Rails which have fractured at a transverse fissure will probably contain other transverse fissures in positions often several feet apart, and if these rails are broken under a press so as to reveal a latent fissure, its appearance is bright and silvery, as shown in Fig. 27.

Fractures in service usually occur after air and moisture have penetrated the fissure, and its appearance is then smooth and black with well defined lines surrounding the area and indicating the progressive nature of the fracture, as shown in Fig. 28.

Sorbitic rails obtained for trial some years ago, now appear to be more subject to this defect than are the other rails in use in Victoria.

These latent defects can be detected by special apparatus which records the position and extent of the defect, and by periodically testing the rails in track, necessary renewals can be made before the rail reaches a dangerous condition.

The very limited number of broken rails resulting from transverse fissures in Victoria has not yet justified the use of track rail testing apparatus.

Service defects which render the rails unserviceable for use, comprise : -

FLANGE CRACKS

In light rails which have the flanges drilled for anchor pins, flange cracks almost invariably occur through the pin holes at $10\frac{1}{2}$ " or $1'1\frac{1}{2}$ " from the rail end, and are due to the hammer blows when driving the pins. When the rail breaks through there is usually evidence of the old fracture at the edge of the flange.

From the same cause semi-circular pieces of the flange are sometimes broken away under the dogspike head. Cuts and indentations at the edge of the flange caused by careless handling, or by wear in contact with fastenings, are frequently the origin of flange cracks.

Weak heel fishplates and want of packing at the heel of switches occasionally result in a flange crack starting adjacent to the web of the switch at the heel. This class of crack usually runs out to the edge of the flange about 3 to 4 inches from the heel, but cases occur when the crack extends into the web and up through the fishbolt holes.

Whatever the cause may have been, a crack in the flange reduces the strength of the rail at that point and will ultimately result in a broken rail.

WEB CRACKS

Web cracks generally occur through the fishbolt holes, and are brought about by continuous contact between the web and the fishbolts, owing to incorrect boring of the fishbolt holes or incorrect expansion gaps. Under these conditions a hammering effect occurs between the shank of the fishbolt and the web of the rail as wheels pass over the joint. This results in shatter cracks which radiate from the bolt holes and extend to the fillets. Sometimes these cracks run along under the heads before breaking through, or pass downwards through the flange near the edges of the sleepers.

With this class of crack there is the considerable danger of a large piece of the rail head breaking out under traffic, and the possibility of derailment.

The joints in level crossings are very susceptible to this class of failure and, being hidden by road material, are difficult to detect by eye, but are readily detected by the metallic sound produced when wheels pass over the joint, or by a light blow from a wooden maul. Welded rails are now supplied for level crossings, with the object of eliminating joints in the roadway.

Effective anchoring of the track to maintain the correct expansion gaps at the joints is necessary to avoid this type of failure, and care should be taken to correctly bore the fishbolt holes for size and position as shown in Table 9.20-9.25.

At insulated joints the whole of the expansion space is taken up by the end post, and it is not possible to avoid bolt contact with the web of the rail, but some cushioning effect is provided by the insulating ferrules between the bolts and the fishplates. See 10.34-10.36, Figs. 47-50.

FILLET CRACKS

Fillet cracks seldom occur under ordinary track conditions, and when they occur at a joint it is usually as a result of shatter cracks running up from the fishbolt holes. In level crossings they are not unusual, and their cause is attributed to the lack of resilience in the road bed at these locations.

The additional section provided by the radial web in 94 and 107 lb. rails is intended to afford extra strength at the junction of the fillet with the web of these rails, and thus reduce the possibilities of fillet cracks.

HEAD CRACKS

Cracks in the heads of sound rails are not numerous and when they occur can generally be traced to accident or improper use rather than to ordinary service conditions.

WELDING CRACKS

As already described in Rail Steel 9.09, the condition of steel can be seriously affected by the application of heat. The use of the oxy-acetylene cutting torch is not permitted in cutting rails for main tracks, other than in emergency, and such rails must be replaced by saw cut rails as soon as practicable thereafter.

The influence of the torch is two-fold in that the surface of the cut is unduly hardened and uneven, in which condition high stresses are concentrated at weak points and cracks develop and extend to the body of the rail.

Building up on the head of the rail at joints and crossings, or the running edge of stock rails and guard rails, unless performed with skill, results in surface and lamination cracks.

Even bonding by the use of the torch may be detrimental to the rail, and in the case of manganese rail is not permitted.

RAIL BURNS

Rail burns caused by the slipping of engine wheels may seriously affect the condition of rail steel causing the metal to flow, as shown in Fig. 29, and to so harden on the surface that cracks develop and extend into the rail head, with the possibility of ultimate failure.

WEAR AND DEFORMATION

In service, rails are subjected to wear and deformation according to nature of service and location. See 18.08.

HEAD FLOW

Under the influence of heavy pressure and the rolling action of the wheel treads and flanges, a movement or flow of metal at the contact surfaces of the rails takes place. This action is in evidence at rail joints and on curves to a greater extent than on straights.

At insulated joints the flow metal may extend across the insulation as shown in Fig. 30, and to maintain insulation it is necessary to chip or file the metal back with a slight radius at the rail end.

On the inner rail of curves, owing to the lateral slipping of the wheels, (see 3.16), and any excess of cant for slow goods traffic thereby throwing extra weight on this rail, flow takes place as in Fig. 31.

The outer rail on curves is subjected to heavy flange pressure, and both abrasion and flow take place as shown in Fig. 32. This flow increases until cracks develop at the junction with the parent rail, and long strips of flow metal break away. Occasionally the crack turns into the head of the parent rail with ultimate fracture of the rail.

SCABBY RAILS

The inclusion of foreign materials, such as mill scale and small steel laps, in the surface of rails results in small holes developing in the running surfaces under service conditions.

Generally these imperfections are not extensive and do not seriously affect the strength of the rail, but flattening and bruising of the rail head may result if the scabs are at all extensive, and in such cases the rail should be removed from main track for use in sidings.

CRUSHED HEADS

Crushed heads are due to the flow metal being crushed by concentrated wheel loading.

Crushing of the rail head at intervals corresponding with sleeper spacing as shown in Fig. 34, may be caused by a hard unyielding formation or by unsuitable sleeper spacing.

On the inner rail of curves the rail head spreads and the unsupported metal is crushed by the action of worn wheels, pieces of metal are broken away and cracks may extend into the rail resulting in fracture, as in Fig. 33.

CORRUGATED RAILS

The condition of corrugation develops in service by the formation of a series of undulations or flats on the running surface of the rail.

Rails affected in this manner present a continuous bright surface but the high spots are noticeably brighter than the depressions as shown in Fig. 35.

The interval between high spots varies from $1\frac{1}{2}$ " to 10" and appears to be influenced by many factors such as speed, class of rolling stock, weight and length of rail and condition of track.

Both rolling stock and the track have definite periods of frequency of vibration and when these frequencies synchronize, corrugation of the rail results.

ROARING RAILS

The condition of rail head shown in Fig. 36 is responsible for the roaring sound produced by the wheels of vehicles and the term roaring rail is frequently used to describe this condition.

Unlike corrugated rails the roaring rail appears to develop bands of hard material about $\frac{3}{8}$ " wide at intervals of $1\frac{1}{4}$ " to 2" apart and wheels make rolling contact only with these bands hence the bright appearance which clearly defines the raised areas.

No satisfactory explanation for the condition of roaring rails has been advanced, though by some it is considered to be due to vibrations in the rolling mills during manufacture of the rails. In service the hard spots are further developed by the vibration of the rails under traffic.

CRIPPLED RAILS

Rails which are bent, kinked, twisted, or otherwise distorted, are described as crippled rails.

Lack of maintenance resulting in undue depressions in the track, wide and irregular sleeper spacing, broken sleepers and irregular adzing, all tend to produce crippled rails. Excessive speed, unbalanced locomotive wheels, heavy axle loads and derailments are other factors responsible for this condition.

When the joint conditions are bad the rails may become permanently set at the ends, especially if the rails are short and of light section. Rails in this condition are described as 'hog backed'.

Lateral and vertical deformation can be corrected by the use of suitable presses, but twisted rails are most difficult to restore by ordinary mechanical processes.

CORROSION

Corrosion occurs on the surface of rails by the action of acid gases contained in a film of moisture, the oxidation of the metal resulting in pitting or flaking away of the surface with a reduction of rail section. Acid gases are present in varying quantities in the atmosphere and in certain classes of ballast, and the presence of moisture enables the action of corrosion to develop.

The rail flange, being a thin broad section, has a large surface area exposed to the formation of moisture film. As films of moisture are retained for longer periods at the base of the rail owing to contact with the sleepers, sleeper plates, and sometimes with the ballast, it follows that the action of corrosion is most severe on the rail flange.

Corrosion is less active on rails where the traffic is frequent, as the presence of oil and the vibration of the rails tends to destroy the moisture films and reduce the effects of corrosion.

In level crossings, on piers and wharves, and in shunting yards where the rails are enclosed by timber or earth materials, corrosion may be most severe on the rail web where the moisture film is exposed to the atmosphere.

At rail joints the moisture film retained promotes more rapid corrosion of the rail. Lubrication of rail joints, primarily effected to reduce mechanical wear, also reduces the effects of corrosion at the joints.

EXPANSION

Under the influence of rising temperatures, steel rails expand and increase in length.

If the rail were free to expand, the amount of expansion would depend upon the length of the rail and the increase in temperature.

A rail 100' long subjected to a rise in temperature of 10 degrees Fah. would increase in length by .006' or a little more than 1/16 inch.

The maximum longitudinal free movement at the joint with Australian Standard rails and fishplates is approximately 7/16 inch.

The 'range' of rail temperature variations depends upon the locality and season of the year, and may in Victoria reach 100 degrees Fah. In these circumstances the maximum length of rail which could freely expand within the 7/16 inch of joint movement would be approximately 70'.

Experience has shown however that long rails when laid in track do not expand freely, but are constrained to a considerable extent in the central portion of the length by the resistance of the track structure. Towards the ends of long welded rails the influence of the joints enables the natural expansion of the rail to become effective.

The effects of creep due to flexing of the track under traffic (see 3.05) tends to release the rail from the restraint of the track structure, and for this reason the application of rail anchors is necessary.

ANCHORING

As the lengths of welded rail vary according to the position of laying and the limitations of transport and handling facilities, and the service conditions also vary according to grade, speed, load and direction of traffic, it is necessary to suitably arrange the rail anchors to meet the conditions. See 3.06 & 10.11.

CONTRACTION

Contraction or reduction in the length of free rails takes place on a fall in rail temperature just as expansion takes place on a rise of rail temperature.

If the amount of contraction exceeds the freedom at each joint the fishbolt will be bent between the fishplates. By the application of sufficient rail anchors the contraction of the rail can be controlled.

RAILS

Weight of Rail	50	50	50	57	60	70	60	60	60	60	60	60
Type	A	B	Stock	Stock	C	Stock	D	D	D	D	D	N
Year	1873	1873	1873	1873	1879	1879	*	1893	1893	1901		
Fig. No. Reference	1	2	3	3	4	5	2	6	6	7		
Height	4"	3.15/16"	3.15/16"	3.15/16"	4 1/4"	4 1/4"	4 3/8"	4 3/8"	4 3/8"	4 1/2"		
Width of Flange	4"	3 1/2"	3 1/2"	3 1/2"	4 3/8"	4 3/8"	4 3/8"	4 3/8"	4 3/8"	4 1/4"		
Width of Head	1 7/8"	2 1/4"	2 1/4"	2 1/4"	2"	2"	2 1/4"	2 1/4"	2 1/4"	2 1/2"		
Thickness of Web	1/2"	1/2"	27/32"	27/32"	9/16"	31/32"	9/16"	1/2"	1/2"	29/64"		
Type of Web	Cvd.	Cvd.	Cvd. Str.	Cvd. Str.	Cvd.	Cvd. Str.	Cvd.	Cvd.	Cvd.	Str.		
No. of Holes	2	2	2	2	2	2	2	2	2	3		
Size of Holes	1" x 7/8"	1" x 7/8"	1" x 7/8"	1" x 7/8"	1 1/8" x 1"	1 1/8" x 1"	1 1/8" x 1"	1 1/4" x 1"	1 1/4" x 1"	1 1/8" d		
First Hole Spacing	2 1/4"	2 1/4"	2 1/4"	2 1/4"	2 1/4"	2 1/4"	2 1/4"	2 1/4"	2 1/4"	2.1/16"		
Other Holes	4"	4"	4"	4"	4"	4"	4"	4"	4"	4 1/2"		
Height of Holes	1.23/32"	1.23/32"	1.23/32"	1.23/32"	1.25/32"	1.25/32"	1.15/16"	1.15/16"	1.15/16"	2"		
* Two head radii used. 1881, 4 1/2" Rad. 1889, 12" Rad.												
RAIL	STANDARD LENGTHS						SPECIAL LENGTHS					
50 A.	23'10"						21'1", 18'4", 15'7"					
50 B.	22'6"						22'2", 16'6", 13'6"					
57 Stock	23'0"						22'8", 20'0", 17'0", 16'0"					
60 D.	23'0", 22'6"						22'2", 18'0", 16'6", 14'0", 13'6"					
60 D.	28'6"						31'6", 28'0", 22'6", 16'6"					
60 N.	31'6"						37'3", 31'2", 29'3"					

RAILS

Weight of Rail	60	60	60	60	60	60	60	60	61	66	78
Type	A.S.	A.S.	A.S.	A.S.	N.S.W.	Sec. 602	S.A.	E	Stock		
Year	1919	1921	1925	1896	1919	1879	1879	1879	1879		
Fig. No. Reference	7	7	7	8	9	10		2	3		
Height	4½"	4½"	4½"	4.5/16"	4⅝"	4½"	4½"	4½"	4½"		
Width of Flange	4¼"	4¼"	4¼"	4"	4"	4"	4"	5"	5"		
Width of Head	2½"	2½"	2½"	2.9/32"	2.9/32"	2.9/32"	2.3/16"	2¼"	2¼"		
Thickness of Web	29/64"	29/64"	29/64"	7/16"	7/16"	7/16"	1/2"	9/16"	31/32"		
Type of Web	Str.	Str.	Str.	Cvd.	Cvd.	Cvd.	Str.	Cvd.	Cvd. Str.		
No. of Holes	3	3	3	3	3	3	2	2	2		
Size of Holes	1⅛" d	1" d	1⅛" d	1.1/16" d	1⅛" d	1⅛" x 1"	1½" x 1"	1⅛" x 1"	1⅛" x 1"		
First Hole Spacing	2.5/32"	2.3/8"	2.7/16"	2.3/8"	2.5/32"	2.5/32"	2.5/32"	2.1/4"	2.1/4"		
Other Holes	4½"	5"	5"	4½"	4½"	4½"	4½"	4"	4"		
Height of Holes	2.1/16"	2.1/16"	2.1/16"	1.27/32"	1.27/32"	1.27/32"	1.13/16"	2"	2"		
RAIL	STANDARD LENGTHS		SPECIAL LENGTHS								
60 A.S.	1919	40'0"	39'8"	31'9"	20'0"						
60 A.S.	1921	45'0"	44'8"	31'9"	22'6"	29'3"	37'3"	31'6"	31'2"		
60 A.S.	1925	45'0"	44'8"	31'9"	22'6"	22'6"					
60 N.S.W.	1896	40'0"	40'0"	30'0"	30'0"						
60 Sec. 602	1919	40'0"	20'7½"	18'0"	20'7½"	18'0"					
61 S.A.	1879	21'0"	22'8"	20'0"	22'8"	20'0"	16'6"	13'6"	22'2"	17'0"	
66 E.	1879	23'0"	22'6"	24'4"	16'0"	24'4"					
78 Stock	1879										

RAILS

Weight of Rail	66	75	75	86	86	75	75	75
Type	F	H	H	Stock	Stock	H	I	G
Year	1886	1885	1888	1885	1888	1888	1881	
Fig. No. Reference	2	2	12	3	13	4	6	4
Height	4 $\frac{1}{2}$ "	4 $\frac{7}{8}$ "	4 $\frac{7}{8}$ "	4 $\frac{7}{8}$ "	4 $\frac{7}{8}$ "	4 $\frac{3}{4}$ "	4 $\frac{3}{4}$ "	4 $\frac{3}{4}$ "
Width of Flange	4 $\frac{1}{2}$ "	4 $\frac{3}{4}$ "	4 $\frac{3}{4}$ "	4 $\frac{3}{4}$ "	4 $\frac{3}{4}$ "	5 $\frac{1}{4}$ "	4 $\frac{3}{4}$ "	5 $\frac{1}{4}$ "
Width of Head	2 $\frac{3}{8}$ "	2 $\frac{1}{2}$ "	2 $\frac{1}{2}$ "	2 $\frac{1}{2}$ "	2 $\frac{1}{2}$ "	2 $\frac{3}{8}$ "	2 $\frac{3}{4}$ "	2 $\frac{3}{8}$ "
Thickness of Web	9/16"	37/64"	9/16"	1"	1"	5/8"	19/32"	5/8"
Type of Web	Cvd.	Cvd.	Cvd.	Cvd. Str.	Cvd. Str.	Cvd.	Cvd.	Cvd.
No. of Holes	2	2	2	2	2	2	2	2
Size of Holes	1 $\frac{1}{8}$ " x 1"	1 $\frac{1}{4}$ " x 1 $\frac{1}{8}$ "	1 $\frac{1}{4}$ " x 1 $\frac{1}{8}$ "	1 $\frac{1}{4}$ " x 1 $\frac{1}{8}$ "	1 $\frac{1}{4}$ " x 1 $\frac{1}{8}$ "	1 $\frac{1}{4}$ " x 1 $\frac{1}{8}$ "	1 $\frac{1}{4}$ " x 1 $\frac{1}{8}$ "	1 $\frac{1}{8}$ " x 1"
First Hole Spacing	2 $\frac{1}{4}$ "	2 $\frac{1}{4}$ "	2 $\frac{1}{4}$ "	2 $\frac{1}{4}$ "	2 $\frac{1}{4}$ "	2 $\frac{1}{4}$ "	2 $\frac{1}{4}$ "	2 $\frac{1}{4}$ "
Other Holes	4"	4"	4"	4"	4"	4"	4"	4"
Height of Holes	2"	2 $\frac{1}{8}$ "	2 $\frac{1}{8}$ "	2 $\frac{1}{8}$ "	2 $\frac{1}{8}$ "	2 $\frac{1}{8}$ "	2 $\frac{1}{8}$ "	2 $\frac{1}{8}$ "

RAIL	STANDARD LENGTHS	SPECIAL LENGTHS
66 F.	1886	22'2", 16'6", 13'6"
72 J.	1886	22'6", 20'0", 17'0", 14'0"
75 H.	1885	29'0", 22'10", 22'8", 20'0", 17'0", 14'0"
75 H.	1888	29'0", 22'10", 22'8", 20'0", 17'0"
86 Stock	1885	29'0", 22'8", 20'0", 17'0"
86 "	1888	29'0", 22'8", 20'0", 17'0"
75 I.	1881	17'0", 14'0"
75 G.		

RAILS

Weight of Rail	75	80	80	95	80	80	80	80	80	90
Type	L	K	0	Stock	A.S.	A.S.	A.S.	A.S.	A.S.	A.S.
Year	1897	*	1897	1897	1915	1921	1925	1925, 35		
Fig. No. Reference	14	15	7	16	7	7	7	7	7	7
Height	5"	5 1/4"	5 1/4"	5 1/4"	5 1/4"	5 1/4"	5 1/4"	5 1/4"	5 1/4"	5.9/16"
Width of Flange	2.7/16"	2 1/2"	5"	5"	5"	5"	5"	5"	5"	5"
Width of Head	11/16"	3/4"	2 3/4"	2 3/4"	2 3/4"	2 3/4"	2 3/4"	2 3/4"	2 3/4"	2 3/4"
Thickness of Web	Cvd.	Str.	Str.	Str.	Str.	Str.	Str.	Str.	Str.	Str.
Type of Web	2	2	3	3	3	3	3	3	3	3
No. of Holes	1 1/8" x 1"	1 1/4" x 1 1/8"	1 1/4" d	1 1/4" d	1 1/4" d	1 1/4" d	1 1/4" d	1 1/4" d	1 1/4" d	1 1/4" d
Size of Holes	2.3/16"	2.3/16"	2.9/32"	2.9/32"	2.9/32"	2.9/32"	2.9/32"	2.9/32"	2.9/32"	2.9/32"
First Hole Spacing	4 1/2"	4 1/2"	5"	5"	5"	5"	5"	5"	5"	5"
Other Holes	2 1/2"	2 5/8"	2.5/16"	2.5/16"	2.5/16"	2.5/16"	2.5/16"	2.5/16"	2.5/16"	2.5/16"
Height of Holes	* Two head radii used. 1879, 5 1/4" Rad. 1882, 12" Rad.									
RAIL	STANDARD LENGTHS			SPECIAL LENGTHS						
75 L.	23'0"	22'8", 20'0", 17'0", 15'6", 15'0", 14'0"								
80 K.	23'0"	44'8", 42'9", 37'3", 31'5", 29'3", 20'3", 22'6"								
80 'O'	45'0", 31'9"	15'0"								
95 Stock	31'9"	44'8", 37'3", 31'9", 22'6"								
80 A.S.	45'0"	44'8", 44'7", 36'0", 31'9", 31'6", 27'0", 22'6"								
80 A.S.	45'0"	44'7", 22'6"								
80 A.S.	45'0"	44'7", 44', 36', 35', 31'9", 31'6", 22'6", 30'0"								
90 A.S.	45'0"									

RAILS

Weight of Rail	94	100	115	100	100	100	100	100	107
Type	A.S.	P	Stock	A.S.	A.S.	B.S.	M	A.S.	A.S.
Year	1937	1897	1897	1915	1925	1924	1889	1937	1937
Fig.No. Reference	17	7	16	7	7	18	19	17	17
Height	5.9/16"	6"	6"	6"	6"	6"	6"	6.3/16"	6.3/16"
Width of Flange	5"	5 $\frac{3}{4}$ "	5 $\frac{3}{4}$ "	5 $\frac{3}{4}$ "	5 $\frac{3}{4}$ "	5 $\frac{3}{4}$ "	5"	5 $\frac{3}{4}$ "	5 $\frac{3}{4}$ "
Width of Head	2 $\frac{3}{4}$ "	3"	3"	3"	3"	2 $\frac{3}{4}$ "	2 $\frac{5}{8}$ "	2 $\frac{3}{4}$ "	2 $\frac{3}{4}$ "
Thickness of Web	9/16"	37/64"	1"	37/64"	37/64"	9/16"	9/16"	37/64"	37/64"
Type of Web	Cvd.	Str.	Str.	Str.	Str.	Cvd.	Cvd.	Cvd.	Cvd.
No of Holes	3	3	3	3	3	3	2	3	3
Size of Holes	1 $\frac{1}{4}$ "d	1 $\frac{1}{4}$ "d	1 $\frac{1}{4}$ "d	1 $\frac{1}{4}$ "d	1 $\frac{1}{4}$ "d	1 $\frac{1}{4}$ "d	1 $\frac{1}{4}$ "x1 $\frac{1}{8}$ "	1 $\frac{1}{4}$ "d	1 $\frac{1}{4}$ "d
First Hole Spacing	2.7/16"	2.9/32"	2.9/32"	2.3/8"	2.7/16"	2.1/8"	2.1/2"	2.1/2"	2.7/16"
Other Holes	5"	5"	5"	5"	5"	4 $\frac{1}{2}$ "	4 $\frac{1}{2}$ "	5"	5"
Height of Holes	2.7/16"	2.43/64"	2.43/64"	2.5/8"	2.5/8"	2.1/2"	2.1/2"	2.43/64"	2.43/64"
RAIL	STANDARD LENGTHS			SPECIAL LENGTHS					
94 A.S.	1937	45'0"	40'0", 36'0"	1915	40'0", 36'0"	31'6"			
100 P.	1897	31'9"	42'9", 37'3"	1925	42'9", 37'3"	31'5", 29'3"			
115 Stock	1897	31'9"	15'0"	1924	15'0"	20'3"			
100 A.S.	1915	45'0", 40'0"	44'8", 39'8"	1915	44'8", 39'8"	37'3", 31'9", 31'6"			
100 A.S.	1925	45'0"	27'0", 22'6"	1925	27'0", 22'6"	20'0"			
100 B.S.	1924	45'0", 40'0"	44'7", 31'9"	1924	44'7", 31'9"	36'0", 22'6"			
100 M.	1889	23'0"	22'10", 20'0"	1889	22'10", 20'0"	17'0"			
107 A.S.	1937	45'0"	40'0", 36'0"	1937	40'0", 36'0"	31'6"			

RAILS

Weight of Rail Type	110 A.S.	90. B.S. Tram	92 Tram	96 B.S. Tram	102 B.S. Tram
Year	1925.35	1903	1912	1927	1933
Fig. No. Reference	7	20	20	20	20
Height	6.7/32"	6½"	6½"	6½"	6½"
Width of Flange	5¾"	6½"	6½"	6¾"	6½"
Width of Head	3"	3½"	3¾"	3¾"	3.63/64"
Thickness of Web	39/64"	13/32"	7/16"	7/16"	15/32"
Type of Web	Str.	Str.	Str.	Str.	Str.
No of Holes	3	3	3	3	3
Size of Holes	1¼" d	1.3/16" d	1.3/16" d	1.3/16" d	1.3/16" d
First Hole Spacing	2.7/16"	2"	2¾"	2"	2"
Other Holes	5"	4"	5¼"	4"	4"
Height of Holes	2.45/64"	2¾"	2.11/16"	2¾"	2¾"
RAIL	STANDARD LENGTHS	SPECIAL LENGTHS			
110 AS	45'0", 22'6"	44'7", 36'0", 31'9", 31'6"			
90 B.S. Tram					
92 Tram	60'0", 40'0"	35'0", 30'0"			
96 Tram	45'0"				
102 Tram	40'0"				

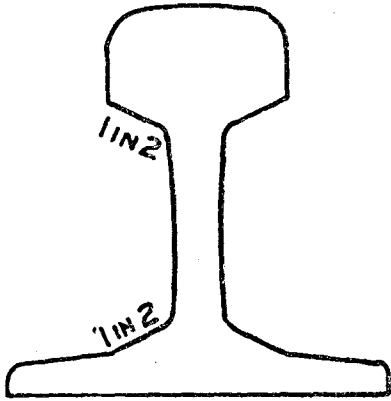

FIG. 1.

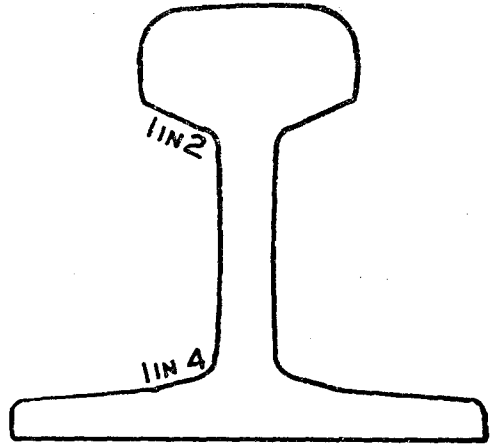

FIG. 2.

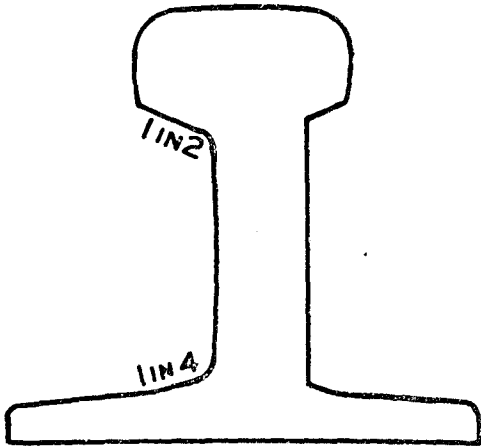

FIG. 3.

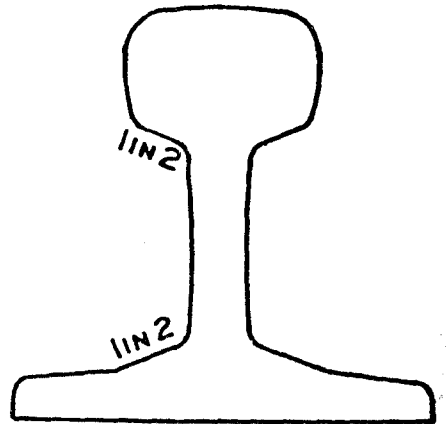
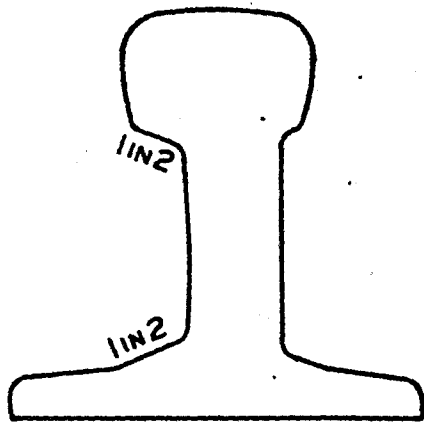
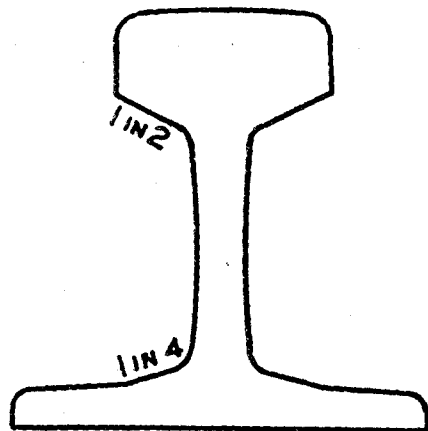
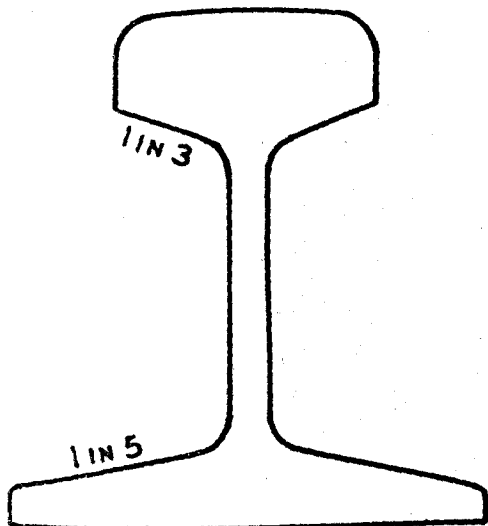
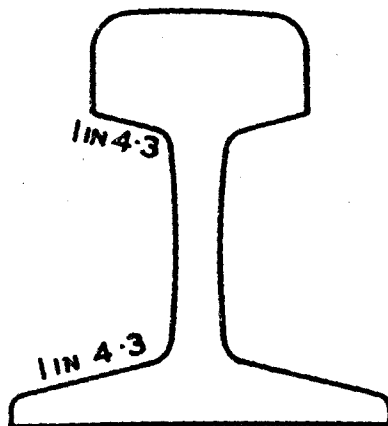

FIG. 4.

FIG. 5.FIG. 6.FIG. 7.FIG. 8.

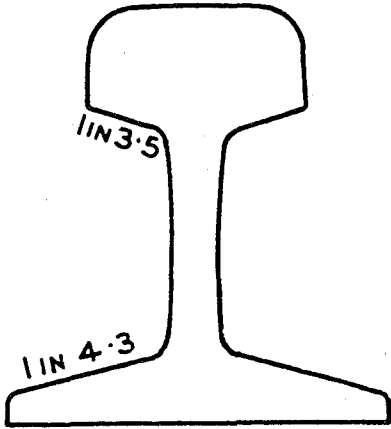

FIG. 9.

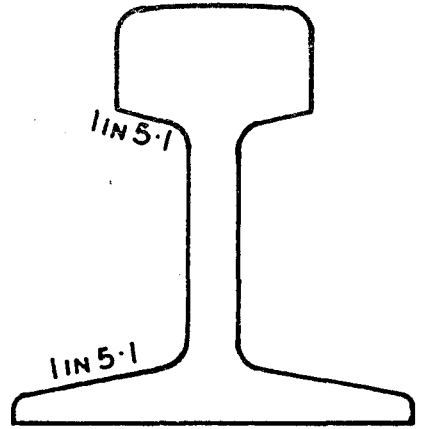

FIG. 10.

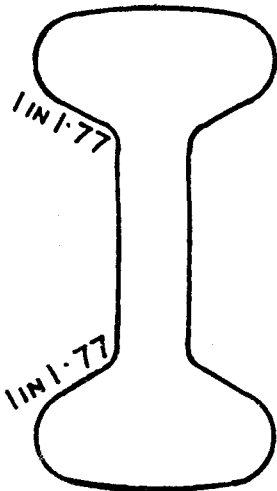

FIG. 11.

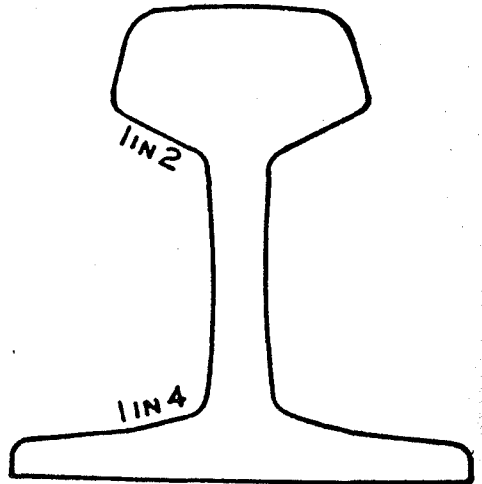

FIG. 12.

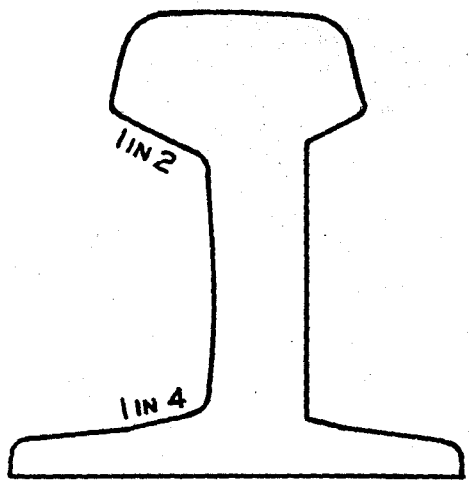

FIG.13.

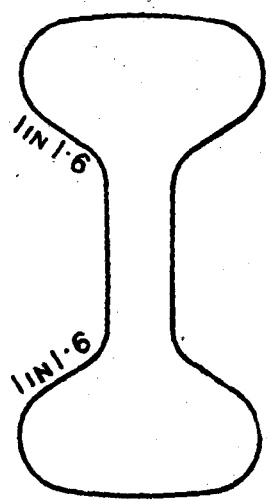

FIG.14.

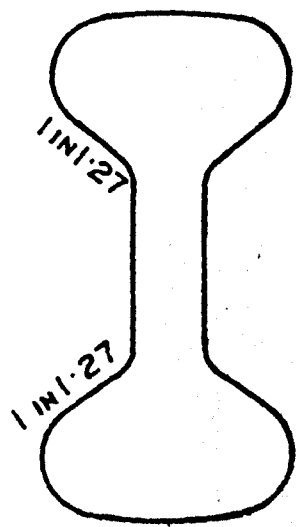

FIG.15.

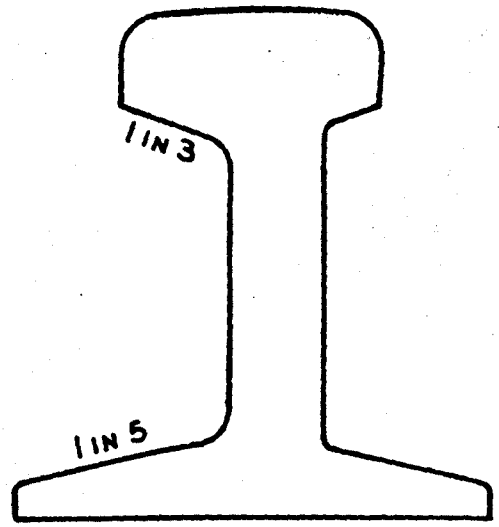

FIG.16

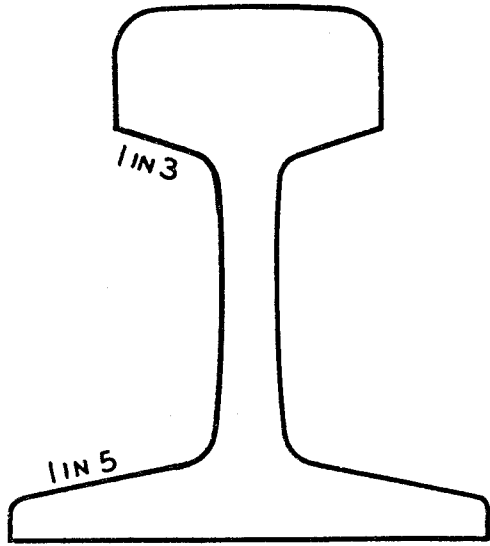

FIG. 17

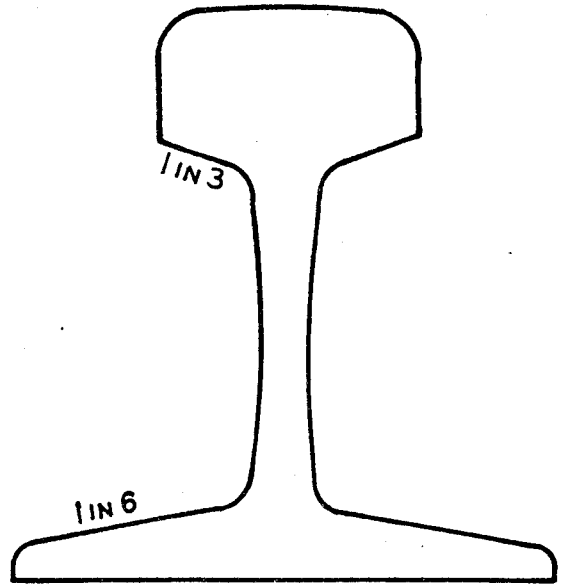

FIG. 18.

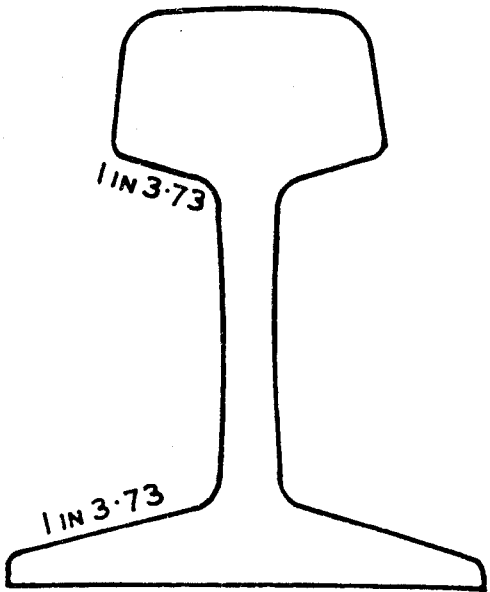

FIG. 19

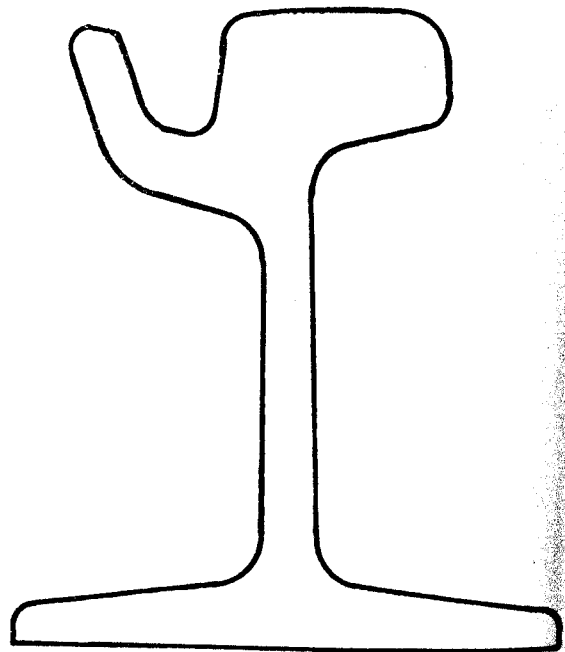

FIG. 20.

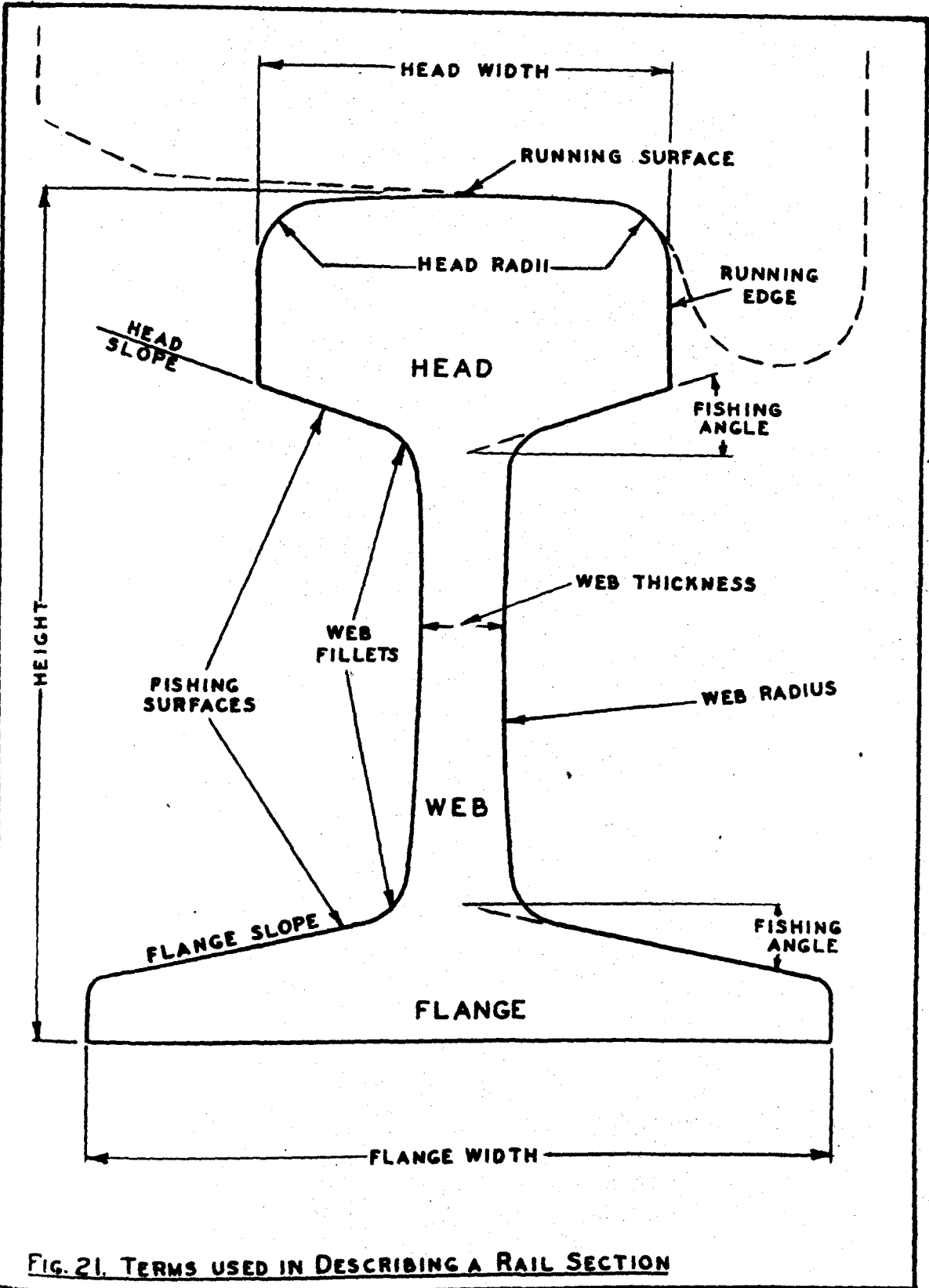

FIG. 21. TERMS USED IN DESCRIBING A RAIL SECTION

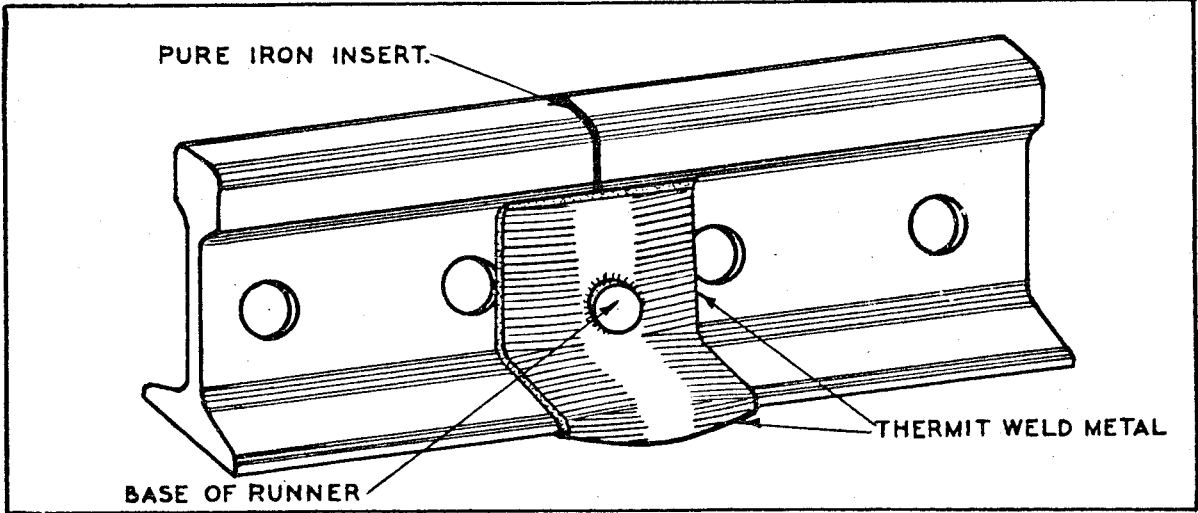

FIG. 22. THE COMBINED THERMIT WELD

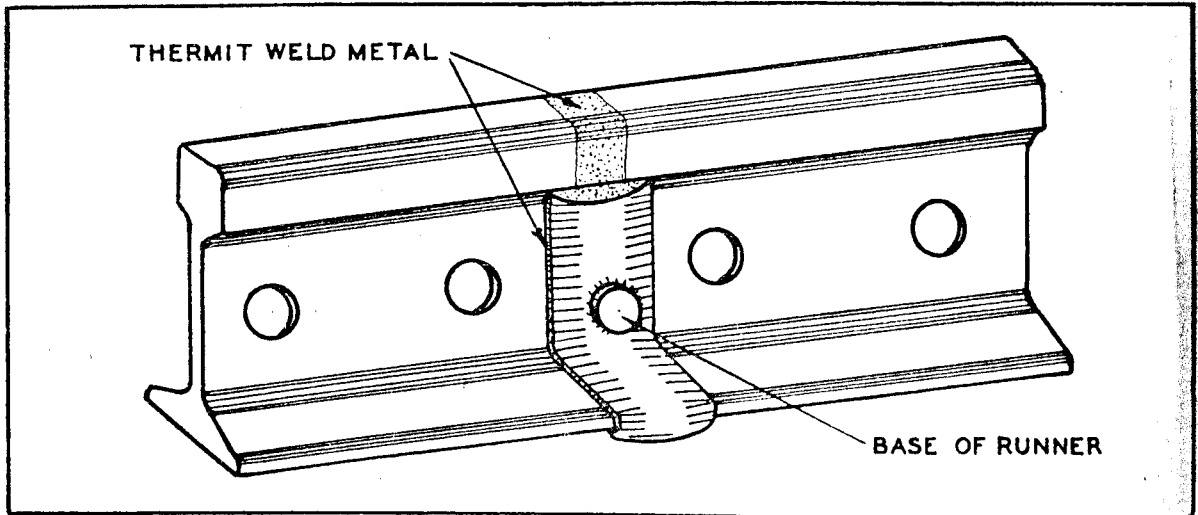

FIG. 23. THE FUSION THERMIT WELD

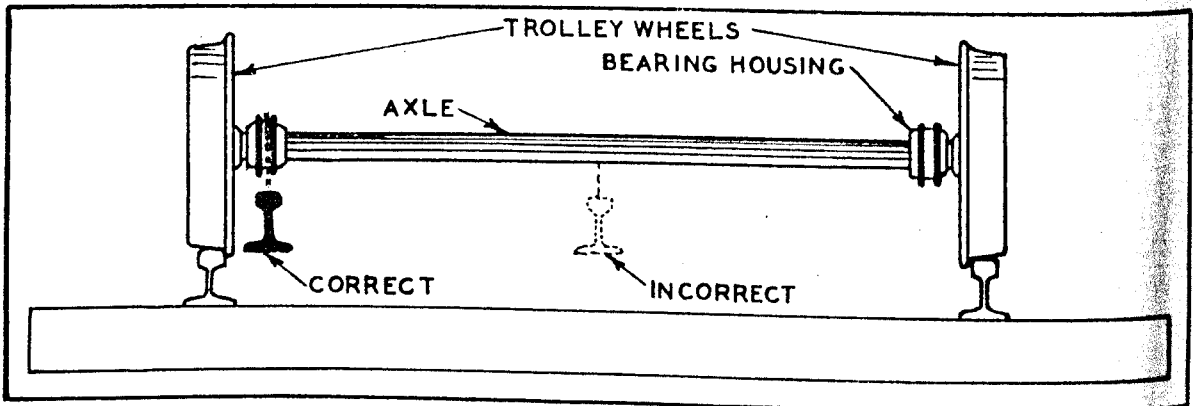

FIG. 24. METHOD OF TROLLEYING RAIL

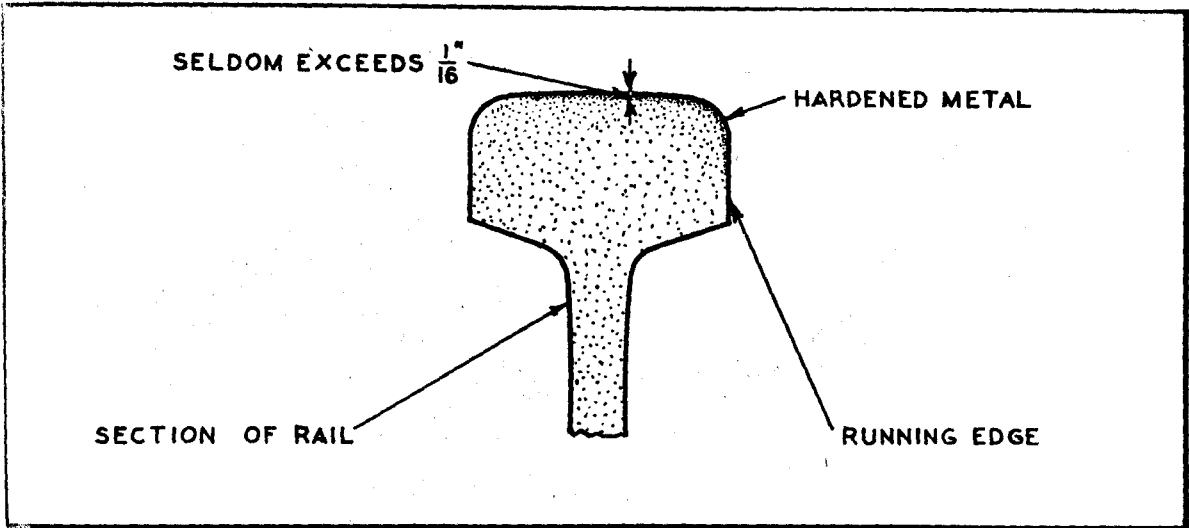

FIG. 25. SKIN OF HARDENED METAL

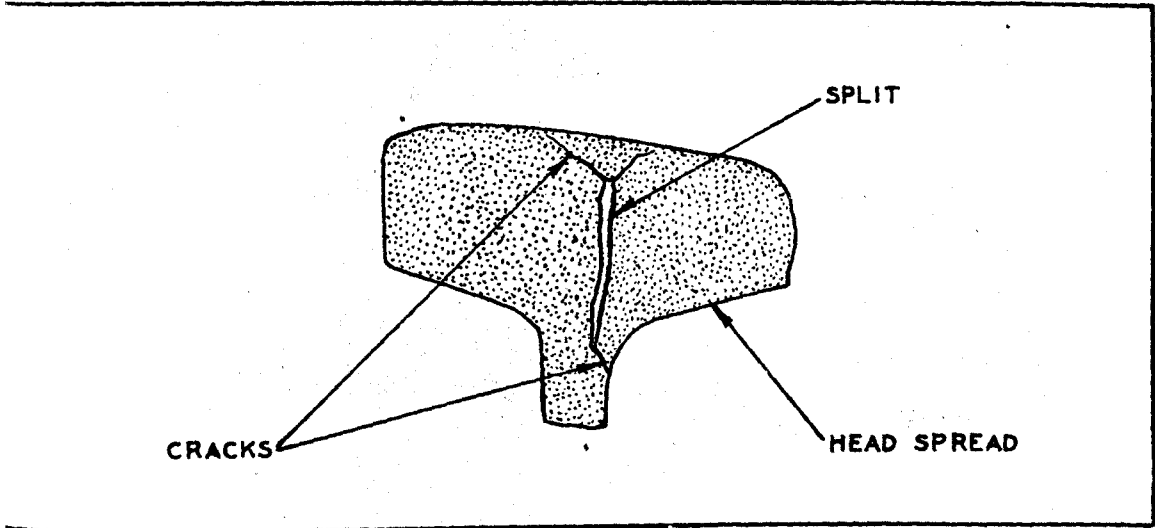

FIG. 26. SPLIT RAIL

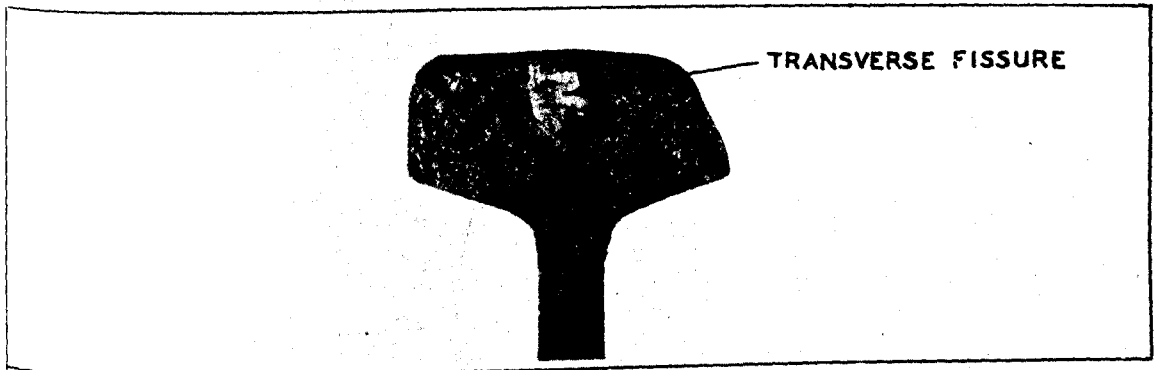

FIG. 27. APPEARANCE OF A TRANSVERSE FISSURE

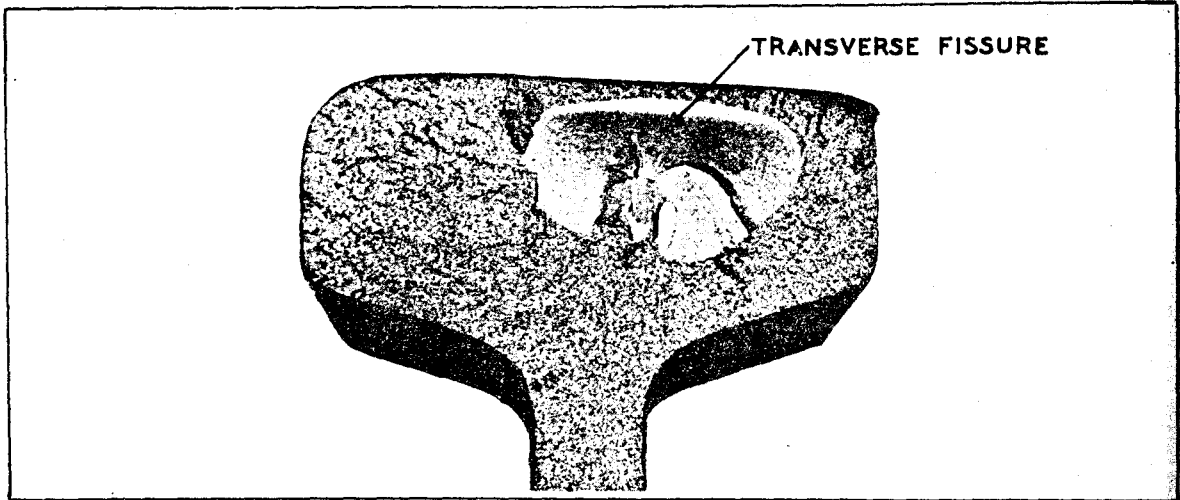

FIG.28. PROGRESSIVE NATURE OF A TRANSVERSE FISSURE

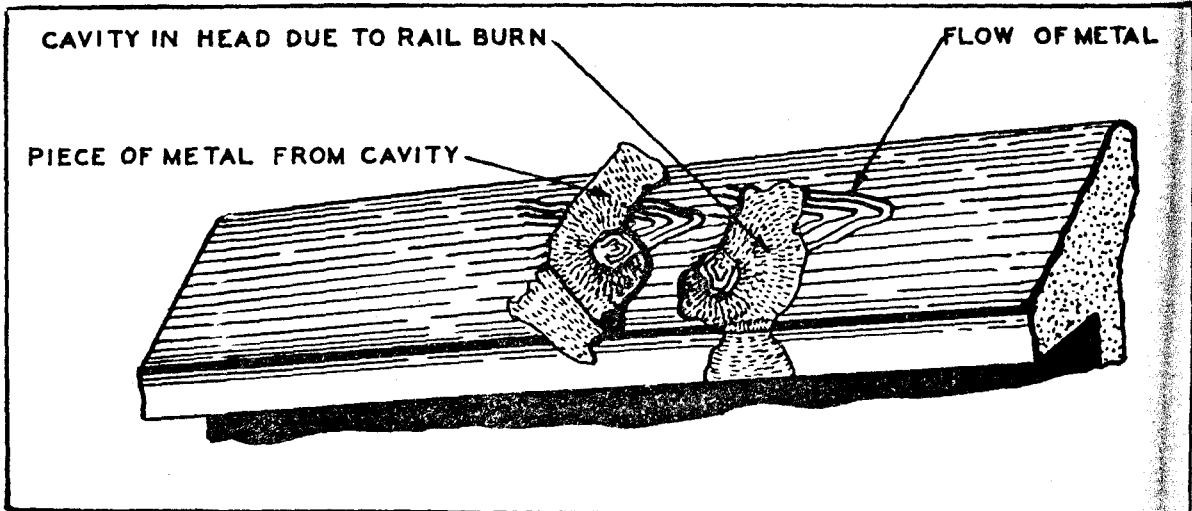

FIG.29. TYPICAL RAIL BURNS

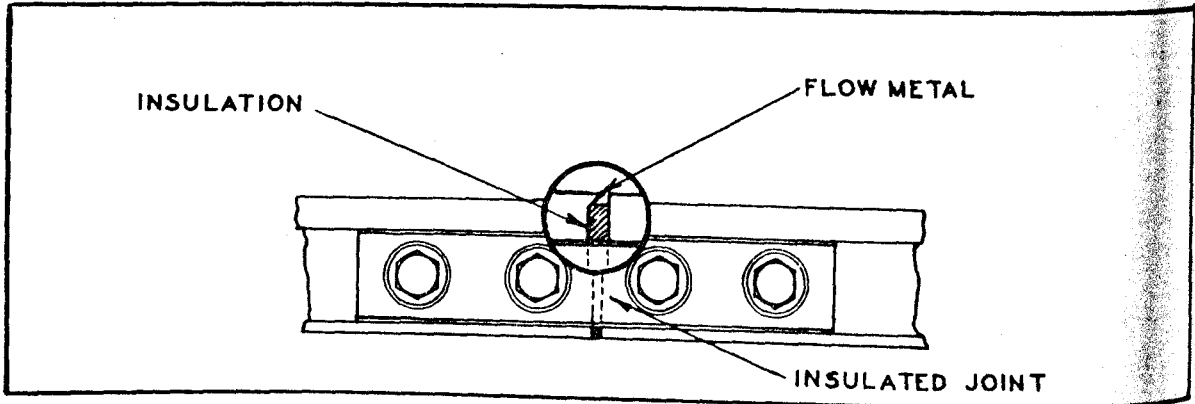

FIG.30. HEAD FLOW AT A INSULATED JOINT

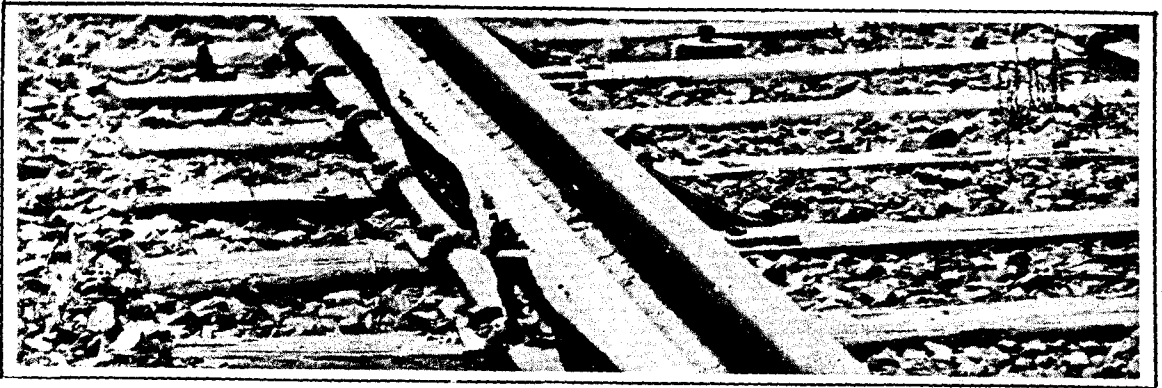

FIG. 31. HEAD FLOW - INNER RAIL OF CURVE

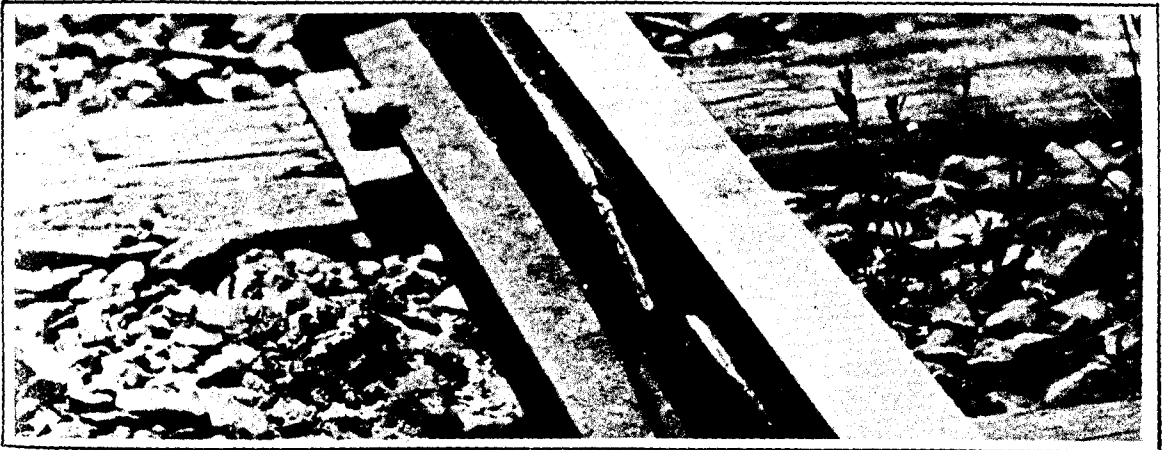

FIG. 32. HEAD FLOW - OUTER RAIL OF CURVE

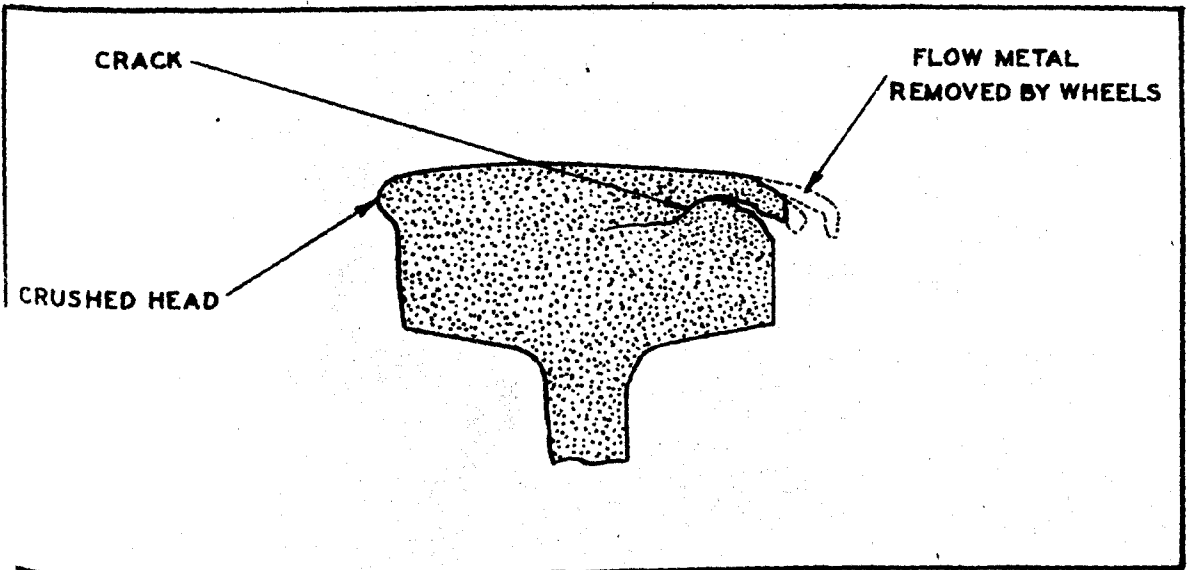

FIG. 33. CRUSHED HEAD

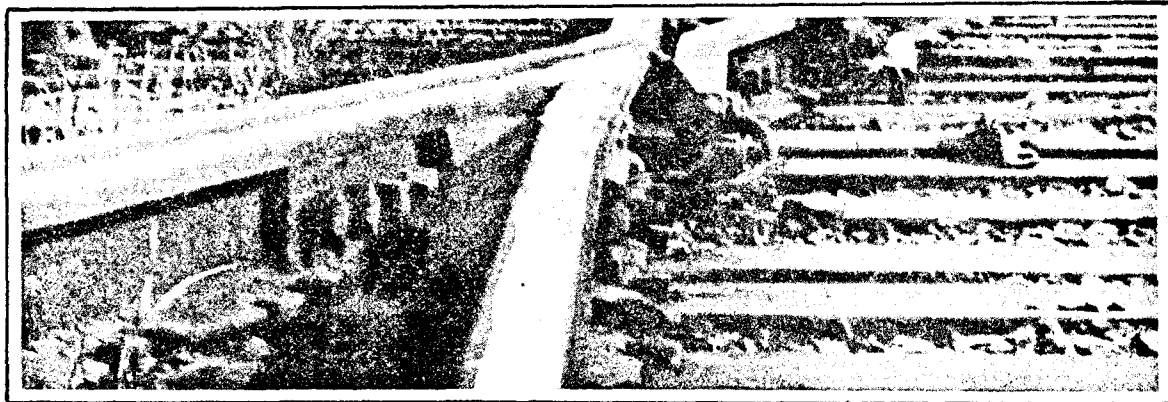

FIG. 34. CRUSHING OF RAIL HEAD.

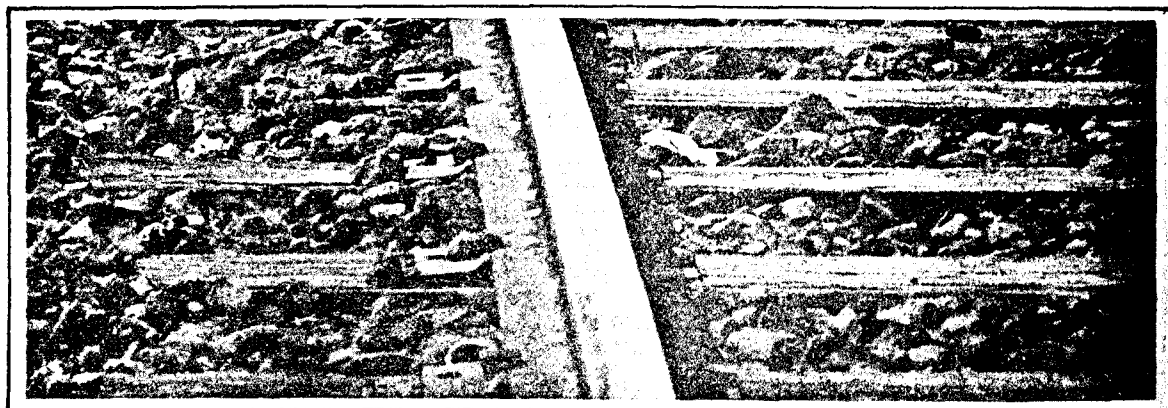

FIG. 35. TYPICAL CORRUGATIONS

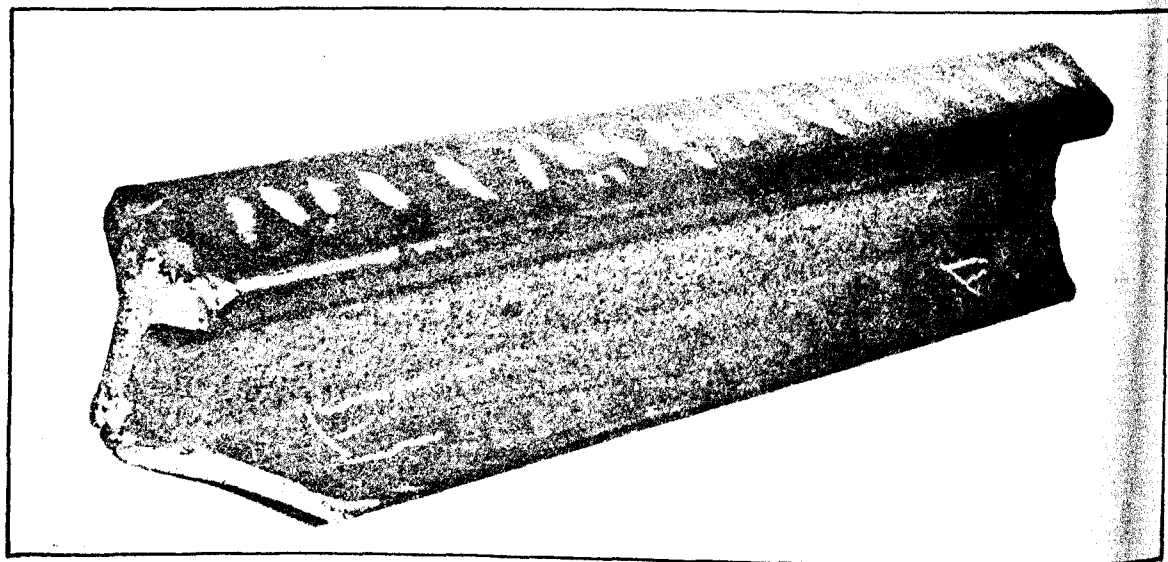

FIG. 36. TYPICAL ROARING RAIL

TRACK FASTENINGS. 10.

DOGSPIKES

The most common track fastening in point of numbers is the dogspike, its purpose being to hold the rails to the sleepers.

Though a simple fastening, it is subjected to three main forces under traffic : -

- (1) Vertical pull due to wave motion of the rail.
- (2) Outward thrust due to pressure of wheel flanges against the rail.
- (3) An overturning tendency of rails on curves.

Vertical pull is opposed by the friction grip of the dogspike in the timber sleeper.

Outward thrust is opposed by the support afforded the dogspike by the timber fibres behind the neck of the spike.

Overturning is resisted by the grip of the inside dogspike opposing withdrawal, and the rigidity of the outside dogspike in opposing bending and forcing back into the timber.

In addition to these forces the dogspike is subjected to abrasion by the repetitive movements of the rail flange against the throat of the spike resulting in throat cutting.

The grip of the dogspike depends upon its form and the class, the condition of the sleeper into which it is driven, hole size and shape of the point.

To enable the dogspike to fulfil its purpose it must be of suitable form to resist deformation in service, and to permit of driving and removal by the use of simple tools.

The shape of the head has been modified from the earlier 'T' head to a rounded or dome-shaped head less susceptible to fracture if mishit in driving. Manufacturing considerations have also dictated the more uniform spread of the metal in the head of the present standard dogspike.

Many types of rail-to-sleepers fastenings have been tried, but the standard in use in Victoria for timber sleepers is the square dogspike, shown in Fig. 1. Particulars of dogspikes are as follows : -

Type	Section	Length	Purpose
A	$\frac{5}{8}$ " square	4 $\frac{1}{2}$ "	Light rail tracks 60 N, D, C, and A.S. 50 A and B
	$\frac{3}{4}$ " "	5"	Medium and heavy tracks, adzed sleepers. 66E and F, 75H and I, 80 O and A.S. 100 P and A.S.
B	$\frac{3}{4}$ " round	5" 6"	" " " 90 and 110 lb. Medium and heavy tracks, plated. 90 and 110 lb.
C	$\frac{3}{4}$ " square	5" 6"	Adzed sleepers. All weights. Plated tracks. 80 to 110 lb.

Notes : - Types 'A' and 'B' are not now manufactured but are reconditioned when released. Type 'C' is standard for all new work and for maintenance when reconditioned dogspikes are not available.

The purpose of pointing the dogspike is two-fold : -

1. To facilitate entry into the hole.
2. To retard the tendency to rotate during driving.

Blunt and badly pointed dogspikes tend to tear the timber fibre, twist the spike in driving, and impair the hold in the sleeper.

In manufacture a fin is extruded between the die faces forming the dogspike head; if this fin is small, rounded and uniform it is not objectionable, but if large and ragged it must be removed. A large fin interferes with the withdrawal of the dogspike and sharp fins can cause injury in handling. The present practice in Victoria is to remove the fins from all dogspikes after manufacture.

Dogspikes released from track are sorted at Spotswood and those suitable for re-use are straightened, re-pointed and re-issued for maintenance purposes. Throat cut dogspikes, if considered serviceable, are used 'reversed' in the location holes of double shouldered sleeper plates.

ELASTIC SPIKES

The tendency for dogspikes to lift under the action of track wave has led to the development of a goose necked spring steel spike of which two types are on trial in Victoria.

In driving elastic spikes a short handled 7 lb. hammer is used, and the spike is driven down to a definite position indicated by a gauge. See 11.19.

RAIL PINS

Rail pins are used at the ends of short length light rails to anchor the rails against creep, and to secure the chairs of double headed rails.

The types of rail pins used are shown in Figs. 2A & 2B, and particulars are as follows : -

Dia.	Length	Purpose	
* $\frac{7}{8}$ "	$6\frac{1}{4}$ "	Rail Chair pins	80 K Double headed rails.
$\frac{3}{8}$ "	$4\frac{1}{2}$ "	Anchor pins	75G, 75H, 75I, 66E & 66F rails.
$\frac{5}{8}$ "	4"	" "	50 A, 60C and 60 D rails.
$\frac{1}{2}$ "	4"	" "	50 B, rails.

* The present standard $\frac{7}{8}$ " dia. pin is the Mark 'P' pin.

MECHANICAL RAIL JOINTS

A pair of fishplates properly secured at abutting rail ends with fishbolts constitutes a mechanical rail joint.

The functions of the mechanical rail joint are : -

1. To join together the ends of the rails in order to bring into alignment their running surfaces and running edges.
2. To properly support the rail ends vertically and laterally without unduly retarding the expansion and contraction of the rails.
3. Aided by the fishbolts, to restrain the longitudinal movement of the rails and prevent undue widening of the expansion space.

The ideal mechanical rail joint would be of exactly the same strength and stiffness as the continuous rail, and thereby carry the wave motion of the rail uniformly along the track.

In the space available in the fishing angle of the rails it is not possible to provide an ideal joint, although endless attempts have been made in this regard.

The types of fishplates in use are shown in Figs. 3-39, and Table 10.12-10.15. For spacing and shapes of holes referred to in the tables, see Fig. 40.

The earlier fishplates used in light rails were of the flat or strap type and met the requirements of traffic at the time of their introduction. As heavier loads and higher speeds came into operation heavier rails and stronger rail joints were developed. At first the fishplates were made heavier, then the length and number of fishbolts were increased. Later the angle and the channel outside fishplates were developed.

With electrification the necessity for bonding the rail joint made the use of outside channel fishplates impracticable.

The vertical lift at the joint, owing to rail wave, became intensified as axle loads increased and wheel centres decreased due to the smaller driving wheels used with modern locomotives. See 3.03.

While angle fishplates are suitable to support the major downward flexure of the rail joint they are susceptible to fracture cracks at the top and ultimate failure from the upward, though lesser, flexure of the joint.

When the joint is too weak to control upward flexure the rail ends assume inclinations as shown in Fig. 41, and with high speed traffic, notwithstanding the action of the vehicle springs, the wheels tend to bound over the joint and land heavily on the receiving rail.

To meet present-day conditions a fishplate is required which will offer a reasonable resistance to upward flexure as well as the necessary resistance to downward flexure. The present Australian Standard bar type fishplates are designed to meet the foregoing conditions. See Figs. 36 & 37.

JUNCTION JOINTS

At the point of junction between rails of different sections special fishplates are required to make the joint.

Junction fishplates are issued in pairs with the bolts in position, and may be either interchangeable or in 'hands' according to the sections of rails concerned and the bolt arrangements.

Typical junction joints are shown in Fig. 42, and the standard junction joints are shown in Table 10.16.

Junctions between light and heavy rail should be avoided except for light traffic; if engines are to use the tracks a length of intermediate weight rail must be installed to effect a gradual reduction in the stiffness of the track.

Cases arise when it is desired to temporarily junction old material with the newer standards and for these locations a forged junction joint is made when required, but no stocks are kept for this purpose.

To determine the hand of junction joints the practice since 1926 is as follows : -

1. View the joint from the centre of the track as shown in Fig. 43.
2. Look from the 'lighter' to the 'heavier' rail section, or from the 'earlier' to the 'later' class when both rails are of the same weight.
3. Describe the hand according to the side of the track for which the joint is required.

Prior to 1926 the hand was determined in the opposite way by looking from the 'heavier' to the 'lighter' rail section, or from the 'later' to the 'earlier' class when both rails were of the same weight.

This change has led to confusion as trackmen have read the marking of existing junctions when ordering replacements, and also serviceable material manufactured prior to 1926 shows the opposite hands.

For many years departmental instructions have required that rails of the same class be used throughout trackwork layouts to avoid junctions between rails of different heights over the crossing timbers.

The earlier junction fishplates were therefore designed only for track conditions and the width of the flange and arrangements of bolts are unsuitable for installation at the ends of many crossings.

Junction fishplates manufactured before 1940 are arranged to join new rails of the stated classes and where serviceable rail is jointed to new rail of different section a drop occurs at the surface of the joint.

Since 1940 allowances have been made for wear on the older class of rail, as shown in Table 10.16. The minus (-) sign adjacent to the weight of rail indicates the extent of the allowance made.

The junction is necessarily weaker than an ordinary joint and therefore an undesirable necessity; it should never be installed at a stock rail or crossing joint or in the track rail at guard rail flangeways.

Unlike ordinary mechanical joints, the junction joint does not lend itself to movement for expansion and contraction owing to the step at the change of rail section, and therefore the bolts should be screwed up tight.

In the 1940 type of junction, high tensile (Mark J) bolts are used with square heads restrained between locking ledges on the fishplates. See Fig. 42.

JUNCTION RAILS

A junction rail is composed of two or more weights and/or classes of rails welded to form a continuous rail as shown in Fig. 44.

In preparing a junction rail the deeper section is heated and pressed to the same height as the lighter section and the ends are flash butt welded.

Another type of junction rail is prepared by machining the running surface and running edge as shown in Fig. 45. This junction rail was used in relaying the Flinders Street to Spencer Street viaduct and was moved forward at each break to connect with the existing rail.

REPAIR FISHPLATES

To effect a temporary repair at a fractured Thermit joint special repair fishplates, shown in Fig. 46, are provided. By reason of the shape of the weld, the repair fishplate operates at a mechanical disadvantage and is necessarily weaker than a standard mechanical rail joint.

For this reason the adjacent sleepers must be brought in closely to support the joint and it should not be regarded as a permanent joint.

A broken Thermit joint constitutes a broken rail and must be reported on the proper form.

INSULATED JOINTS

With the advent of electric traction and electric signalling, it became necessary to isolate sections of the track by means of insulated joints.

The earlier insulated joints were of wood sometimes reinforced by steel work; many of these joints are still in service and a typical joint of this type is shown in Fig. 47.

Later types embodied fishplates of a section smaller than the rail with insulating material interposed in the fishing angle, as shown in Figs. 48 & 49.

The 1939 standard insulated joints have been designed to increase the strength and stiffness of the joints and reduce the damage to insulating materials. See Table 10.17.

To meet conditions where an insulated joint is required at a point of change in rail section, several junction insulated joints have been provided, as shown in Table 10.17.

It is not possible to provide for expansion and contraction of the rail at insulated joints, and the 1939 standards are supplied with high tensile steel bolts (Mark I) without spring washers.

When installing insulated joints of all types the joint bolts should be screwed up hard and be kept tight at all times.

The insulation arrangement provides for insulation as follows : -

1. Between the rail ends.
2. Between the rails and the fishplates.
3. Between the joint bolts and the fishplates.

If a bridle is used to hold the joint bolts for tightening, it must not be placed across the heads of the two inner bolts or the joint will be short-circuited.

The correct and incorrect methods of applying the parts of an insulated joint are shown in Fig. 50.

Assembly is facilitated if two bolts with free running nuts are used to fit up the joint prior to installing two of the permanent, nut tight, mark 'I' bolts and screwing up to hold the joint.

The temporary bolts should then be replaced with mark 'I' bolts and all bolts be tightened hard up to lock the joint.

FISHBOLTS

The efficiency of the mechanical rail joint depends largely on the ability of the fishbolts to hold the fishplates tightly to the fishing faces of the rail.

Under traffic the wedging action between the fishplates and the fishing angles of the rails sets up high tension stresses in the fishbolts. To withstand these stresses without permanently stretching, the fishbolts are now made from steel having a tensile stress of 35 tons per square inch compared with the earlier fishbolts of 28 tons per square inch.

High tensile steel of 50 tons per square inch is used for the mark 'I' and 'J' bolts and for crossing bolts, but this steel is unsuitable for ordinary rail joints where expansion is permitted to operate.

Some high tensile fishbolts are in use in welded tracks and are identified by the letter 'B' on the bolt heads.

The types of fishbolts for mechanical rail joints, junction joints and insulated joints in use in Victoria are shown in Fig. 51, and Tables 10.18-10.24.

Various types of nuts are in use designed chiefly with a view to preventing the nuts from backing off in service, but the present standard nuts are hexagonal plain nuts tapped to be spanner tight after $1\frac{1}{2}$ turns by hand.

As the various types of fishplates in use require fishbolts of different lengths, several lengths are provided to cover the range of fishplates in service. In some instances the fishbolts are slightly longer than necessary, but it is considered more economical to provide this extra length than to maintain stocks of intermediate size fishbolts.

The lengths of fishbolts which should be used with the various fishplates are set out in Tables 10.20-10.21.

If rails pull apart to the extent that the fishbolts are in contact with the web of the rail, bending stresses will be set up in the fishbolts, and under traffic severe impact is imparted to the bolts. Under these conditions fishbolts fracture as shown in Fig. 52. Similar conditions obtain when the bolt holes are incorrect in size and position.

SPRING WASHERS

Various types of spring washers are in use and for the most common types met with see 14.131.

The Australian Standard spring washers have been in general use for some years, but as these washers are rather weak for present-day service, the type 1944 arched spring washer has been recently introduced. The type 1944 washer for 1" diameter fishbolts has a reactive pressure of approximately 8 tons compared with approximately $\frac{3}{4}$ ton with the Australian Standard spring washer.

The correct manner of installing the type 1944 washer is shown in Fig. 53, and with an average nut fitting the tightening should be that which an average man can apply with the standard track spanner when pulling upwards with both feet placed outside the rail.

SLEEPER PLATES

Although Australian hardwood sleepers have a higher resistance to surface damage at the rail seat than the softer timbers used overseas, nevertheless considerable abrasion occurs under the rail, and to distribute this action over a larger area of timber, sleeper plates are now generally installed when re-laying or re-sleeping main tracks.

The single shouldered sleeper plate, shown in Fig. 54, was first rolled in 1925 and many thousands are in use.

In 1939 the double shouldered sleeper plate, shown in Fig. 55, was introduced and is the present standard.

The shoulders are provided to reduce throat cutting of the dogspikes and reduce the lateral movement of the rails which movement formerly tended to widen the gauge. Being tied together by the sleeper plate, both the inside and the outside dogspikes oppose any lateral movement of the rail.

Rail inclination is better maintained, owing to the large area of the plate resting on the sleeper, and is more uniform than with adzed sleepers, provided the surface of the sleeper is flat. Frictional resistance to creep is reduced by contact of metal with metal and rail anchors are therefore necessary.

Slewing of the sleepers is opposed by the shoulders and this permits of cross spiking on one rail without so doing on the other rail as is necessary with adzed sleepers.

Double shouldered sleeper plates were designed to afford protection to both the inside and outside dogspikes from throat cutting. In addition two separate holes were provided for plate location dogspikes, thus relieving the rail dogspikes of all lateral stress and confirming their purpose to holding the rail down to the sleeper plate.

This feature should be clearly understood as every-day experience points to early spike killing of sleepers when the rail dogspike is subjected to repetition lateral and vertical forces. The location dogspikes should be driven to contact the opposite edges of the location holes to prevent lateral movement of the sleeper plate; if this precaution is omitted the location dogspikes could as well be left out.

BRIDGE PLATES

Bridge Plates are of the same cross section as single shouldered sleeper plates, and were provided to afford additional support against downward flexure at rail joints. See Fig. 56.

With a well maintained track and slow heavy traffic the bridge plate has definite advantages in keeping the joint in surface under vertical downward loading.

When the track is springy and speeds are high the bounding effect of the wheel over the joint tends to increase the flattening of the receiving rail owing to the anvil action of the bridge plate. Bridge plates are therefore going out of use for main tracks carrying fast traffic.

SPECIAL TRACK PLATES

As track rails are laid at a rail inclination of 1 in 20 and the rails in trackwork layouts are vertical, it is necessary to provide a means of gradually changing the rail inclination where these rails meet.

On adzed sleepers this is effected by gradually changing the slope of the adzing, but in plated track special track plates, mark A, B, and C, are provided and referred to as graduated cant plates. These plates are machined from standard sleeper plates and stamped according to their inclination, as shown in Fig. 57.

When insulated joints occur in plated track, special track plates are provided as shown in Fig. 58. These plates are cut from serviceable bridge plates and the outside notches are not used. Particulars of these plates are as follows.

Detail Number	U s e
1034	80, 90 and 94 lb. R.H.
1035	" " " L.H.
1036	100, 107 and 110 lb. R.H.
1037	" " " L.H.

ANCHOR STRAPS

When long welded rail was first introduced, anchor straps, $2\frac{1}{2}$ " x $5/16$ " x $3/8$ " and 15' to 16' long, were pinned to the sleepers at the centres of welded rail lengths, and short lengths of angle fishplate with notches for anchor dogs were attached to both rails at the centres for the purpose of controlling the creep.

Experience has shown that anchor straps are generally unnecessary and frequently ineffective, particularly if the two rails tend to creep in opposite directions, and in new work they are not applied, many however are still in welded track.

RAIL ANCHORS

Many types of rail anchors exist, the most suitable being those readily applied and easily adjusted to meet changing conditions in the track. Of the types used in Victoria some are no longer purchased, but are still met with in the tracks.

Among the earlier rail anchors used were the Winby, Vaughan, Adderly, and M and B, as shown in Fig. 59.

The present standard rail anchor in use is the 'Fair' one piece rail anchor which is readily applied, adjusted, or removed by a blow from a spiking hammer. See Fig. 60.

Fair rail anchors in use are of three types, straight bar, bow, and deep bow; the straight bar is the old type used with adzed sleepers of good square section, the bow was introduced to get a bearing lower on the sleeper where round backs were encountered, and the deep bow (now standard) is provided for use on plated tracks.

All of these rail anchors are of the friction grip pattern and obtain their grip on the rail flange by mutual distortion between the rail anchor and the rail flange.

Rail anchors of the friction grip distortion type are not used on iron and low carbon steel rails, as the resistance or spring in rail flanges of this class is insufficient to develop the necessary grip of the rail anchor.

TYPE & YEAR OF FISHPLATE		YEAR OF MATING RAIL	LENGTH OF PLATE	HOLE SPACING		SHAPE OF HOLES	NO OF HOLES	DIA. OF BOLT	FIG NO REF
				A	B				
50 A.			1'5"	4"	4 $\frac{5}{8}$ "	Nib	4	3 $\frac{3}{4}$ "	3
50 B.	1873	1873	"	"	"	"	"	"	4
57 Stock	"	"	"	"	"	"	"	"	"
60 C.	1879	1879	"	"	"	"	"	7 $\frac{7}{8}$ "	3
70 Stock	"	"	"	"	"	"	"	"	"
60 D.	1881	1881, 89, 93	"	"	"	"	"	"	6
"	1889	"	"	"	"	"	"	"	7
"	1893	"	"	"	"	"	"	"	9
60 N.	1901	1901	2'3"	4 $\frac{1}{2}$ "	4 $\frac{1}{2}$ "	Oval	6	"	27
60 A.S.	1919	1919	"	"	"	"	"	"	23
"	1921	1921	2'6"	5"	5"	"	"	5 $\frac{3}{4}$ "	"
"	1925	1925	"	"	"	"	"	7 $\frac{7}{8}$ "	24
60 N.S.W.	1896	1896	2'7"	"	4 $\frac{3}{4}$ "	"	"	3 $\frac{3}{4}$ "	25
60 Sec. 602	1919	1919	2'3"	4 $\frac{1}{2}$ "	4 $\frac{1}{2}$ "	Oval & Round	6	7 $\frac{7}{8}$ "	26
61 S.A.	1879	1879	1'6"	"	"	Square & Round	4	"	22
66 E. 1879 Light		1879	1'5"	4"	4 $\frac{5}{8}$ "	Round	"	"	8
" " Heavy		1879	"	"	"	Nib	"	"	7
78 Stock "		1879	"	"	"	"	"	"	"

Note : - For spacing and shapes of holes see Fig. 40.

TYPE & YEAR OF FISHPLATE	YEAR OF MATING RAIL	LENGTH OF PLATE	HOLE SPACING		SHAPE OF HOLES	NO OF HOLES	DIA. OF BOLT	FIG. NO. REF.
			A	B				
			FISHPLATES					
66 F.	1886	1'5"	4"	4 $\frac{5}{8}$ "	Nib	4	$\frac{7}{8}$ "	7
66 E. & F.	1929	1'11"	"	"	Oval & Round	"	"	15
72 J.		1'6"	4 $\frac{1}{2}$ "	4 $\frac{1}{2}$ "	Round	"	"	10
75 H.	1885	1'5"	4"	4 $\frac{3}{8}$ "	Nib	"	1"	13
" "	1888	"	"	"	"	"	"	14
86 Stock	1885	"	"	"	"	"	"	7
75 H. & I.	1929	2'1"	"	"	Oval & Round	6	"	15
75 I.	1881	1'5"	"	"	Nib	4	"	6
75 G.		"	"	"	Round	"	$\frac{7}{8}$ "	11
75 L.	1879	1'6"	4 $\frac{1}{2}$ "	4 $\frac{1}{2}$ "	Oval	"	"	5
80 K.	"	"	"	"	Round	"	1"	12
80 'O'	1897	2'6"	5"	5"	Oval & Round	6	"	27
95 Stock	"	"	"	"	"	"	"	19
80 A.S. -N.S.W.	1919	"	"	"	"	"	"	28
80 A.S.	1915	"	"	"	"	"	"	29
" "	1921	"	"	"	"	"	"	30
80/90 A.S.1925,28,35		"	"	"	Oval & Round	"	$\frac{7}{8}$ "	34

Note : - For spacing and shapes of holes see Fig.40.

FISHPLATES

TYPE & YEAR OF FISHPLATE	YEAR OF MATING RAIL	LENGTH OF PLATE	HOLE		SHAPE OF HOLES	NO OF HOLES	DIA. OF BOLT	FIG. NO. REE
			A	B				
94 A.S.	1937	2'1"	5"	5"	Oval & Round	4	1"	34
" "	"	1'8"	"	"	"	"	"	36
100 P.	1897	2'6"	"	"	"	6	"	27
115 Stock	"	"	"	"	"	"	"	19
100 A.S.	1915, 25	"	"	"	"	"	"	29
" "	" "	"	"	"	"	"	"	30
" "	" "	2'3"	"	"	"	4	"	31
" B.S.	1924	"	4½"	4½"	Round	6	"	32
" M.	1889	1'7"	"	5½"	Nib	4	"	33
107 A.S.	1937	1'8"	5"	5"	Oval & Round	"	"	37
100/110 A.S.	1915, 25, 35	2'1"	"	"	"	"	"	35
60 A.S.	Flat	1'8"	"	"	"	"	7/8"	18
" "	"	2'6"	"	"	Oval	6	"	"
" "	X Layout	2'1"	"	"	"	5	"	16
80 '0'	Flat	2'6"	"	"	Oval & Round	6	1"	18
" "	X Layout	2'1"	"	"	"	5	"	"
" "	Y	"	"	"	"	"	1½"	17
" A.S.	Flat	2'6"	"	"	"	6	1"	18
" "	X Layout	2'1"	"	"	"	5	"	"
" "	Y	"	"	"	"	"	1½"	17

Note: - For spacing and shapes of holes see Fig. 40.

TYPE & YEAR OF FISHPLATE		YEAR OF MATING RAIL	LENGTH OF PLATE	HOLE SPACING		SHAPE OF HOLES	NO OF HOLES	DIA. OF BOLT	FIG. NO. REF.
				A	B				
90 A.S.	Flat	1925,35	1'8"	5"	5"	Oval & Round	4	1"	20
" "	Y Layout	" "	"	"	"	Round	"	1 $\frac{1}{8}$ "	"
94 "	" "	1937	"	"	"	"	"	"	36
100 P.	Flat	1897	2'6"	"	"	Oval & Round	6	1"	18
" "	X Layout	"	2'1"	"	"	"	5	"	"
" "	Y "	"	"	"	"	"	"	1 $\frac{1}{8}$ "	17
100 A.S.	Flat	1915,25	2'6"	"	"	"	6	1"	18
" "	X Layout	" "	2'1"	"	"	"	5	"	"
" "	Y "	" "	"	"	"	"	"	1 $\frac{1}{8}$ "	17
107 A.S.	" "	1937	1'8"	"	"	Round	4	"	37
110 "	Flat	1925,35	"	"	"	Oval & Round	"	1"	20
" "	Y Layout	" "	"	"	"	Round	"	1 $\frac{1}{8}$ "	"
" "	Y.L.O. 1932	" "	1'6"	"	"	"	"	"	21
90	B.S. Tram Flat	1903	1'8"	4"	4"	Oval & Round	4	1"	38
" "	" 1903	"	2'0"	"	"	Square&Round	6	"	39
92	Tram	1912	2'7"	5 $\frac{1}{2}$ "	5 $\frac{1}{4}$ "	Oval & Round	"	"	"
96	B.S. Tram	1927	2'0"	4"	4"	Square&Round	"	"	"
102	" 1933	1933	"	"	"	"	"	"	"

Note : - For spacing and shapes of holes see Fig.40.

JUNCTION FISHPLATES		
FROM	TO	ASSEMBLY
<u>Previous to TYPE 1940</u>		
60 lb D.	60 lb A.S.	Right or Left Hand Pairs
"	75 lb H.	" " "
"	80 lb 'O'	" " "
"	80 lb A.S.	" " "
60 lb A.S. 5" centres	66 lb E.	" " "
" "	75 lb H.	" " "
" "	80 lb 'O'	" " "
" "	80 lb A.S.	" " "
75 lb H.	80 lb 'O'	" " "
"	80 lb A.S.	" " "
"	90 or 94 lb A.S.	" " "
80 lb 'O'	100 lb P.	" " "
"	100 lb A.S.	" " "
80 lb A.S.	"	" " "
100 lb A.S.	110 lb A.S.	" " "
<u>TYPE 1940</u>		
80 lb 'O' - $\frac{1}{8}$ "	90 or 94 lb A.S.	Common Pair
" " "	107 lb A.S.	" "
80 lb A.S. - $\frac{1}{16}$ "	90 or 94 lb A.S.	Right or Left Hand Pairs*
" " "	107 lb A.S.	Common Pair
90 or 94 lb A.S.	100 lb A.S. - $\frac{1}{16}$ "	Right or Left Hand Pairs
" "	107 lb A.S.	Common Pair
" "	110 lb A.S.	Right or Left Hand Pairs
100 lb A.S. - $\frac{1}{16}$ "	107 lb A.S.	" " "
107 lb A.S.	110 lb A.S.	" " "

*Joint bolts can be inserted only from the gauge side of the 'V' ends of crossings; to enable this to be done with 80 lb. A.S. to 90 or 94 lb. A.S. junction fishplates, pairs of the opposite hand must be used.

INSULATED JOINTS

TYPE 1939 INSULATED JOINTS

WEIGHTS OF RAILS

80 - 90 - 94 lb. A.S.
 100 - 107 - 110 lb. A.S.

TYPE 1939 JUNCTION INSULATED JOINTS

FROM	TO	ASSEMBLY
80 lb. A.S. -1/16"	90 or 94 lb. A.S.	Common Pair
100 lb.A.S. -1/16"	107 lb. A.S.	Right or Left-hand Pairs
100 lb.A.S. -1/16"	110 lb. A.S.	Common Pair
107 lb.A.S.	110 lb. A.S.	Right or Left-hand Pairs

NOTE : - (-1/16") shown above denotes that allowance has been made for 1/16" top head wear in the older rails.

The mark 'I' insulated joint bolt is used for all the above joints, and must be inserted from the gauge side where possible.

ORIGINAL FISHBOLTS						
LENGTH	DIA-METER	SHAPE			WASHER	USE: (TYPE OF FISHPLATE)
		HEAD	NECK	NUT		
a. 4 $\frac{1}{2}$ "	$\frac{7}{8}$ "	Cup	Nib	Square	-	60 lb. C. & D.
b. 4 $\frac{1}{8}$ "	"	"	"	"	-	66 lb. E. 1879 (Heavy)
4 $\frac{1}{8}$ "	"	"	"	Hex.	$\frac{1}{4}$ "	66 lb. F. 1886 70 & 78 lb. Stock
4 $\frac{1}{4}$ "	"	"	Oval	Hex.	$\frac{1}{4}$ "	60 lb. A.S. 1919, 25 80 lb. A.S. 1921
4 $\frac{1}{8}$ "	"	"	"	"	"	60 lb. N. 66 lb. E. & F. 1929 60 lb. A.S. X.L.O. Heel 60 lb. A.S. Flat
4"	"	"	Square	Square	"	61 lb. S.A.
3 $\frac{3}{4}$ "	"	"	Oval	Hex.	"	60 lb. Sec. 602
3 $\frac{3}{4}$ "	"	Square	Round	Square	"	75 lb. G. 75 lb. L. 72 lb. J.
3 $\frac{5}{8}$ "	"	"	"	"	"	66 lb. E. 1879 (Light)
4"	$\frac{3}{4}$ "	Cup	Oval	Hex.	"	60 lb. A.S. 1921
3 $\frac{5}{8}$ "	"	"	"	"	"	60 lb. N.S.W.
a. 3 $\frac{3}{4}$ "	"	"	Nib	Square	-	50 lb. A. & B. 57 & 58 lb. Stock

a. Supplied with 2 square nuts.
b. Supplied with an Ibbotson nut.

ORIGINAL FISHBOLTS

LENGTH	DIA- METER	SHAPE			WASHER	USE:(TYPE OF FISHPLATE)
		HEAD	NECK	NUT		
6 $\frac{3}{4}$ "	1"	Hex.	Round	Hex.	$\frac{1}{8}$ " Flat	100-110 lb. Weld Repair Plates
6"	"	"	"	"	"	80 - 90 lb. " " "
5 $\frac{3}{8}$ "	"	Cup	Oval	"	$\frac{3}{8}$ "	80-90 lb. A.S. 1925, 28, 35 100 lb. A.S. 1923 100-110 lb. A.S. 1925, 28 94 lb. A.S. 1937, 39 107 lb. A.S. 1937
a. 5 $\frac{1}{2}$ " b. 4 $\frac{3}{4}$ "	" "	" "	" "	" "	- $\frac{3}{8}$ "	80 lb. 'O' 80 lb. A.S. 1915 100 lb. P. 100 lb. A.S. 1915, 21 80 lb. 'O' & A.S. Flat 90 & 110 lb. A.S. Flat 100 lb. P. & A.S. Flat 95 & 115 lb. Stock 75 lb. H. & I. 1929
4 $\frac{3}{4}$ "	"	Square	Round	"	"	100 lb. B.S.
c. 4 $\frac{5}{8}$ " d. 4 $\frac{1}{2}$ " 4 $\frac{3}{8}$ "	" " "	Cup " "	Nib " "	Square - Hex.	- $\frac{3}{8}$ " "	75 lb. I. 75 lb. H. 1885, 88 86 lb. Stock 100 lb. M.
e. 4 $\frac{5}{8}$ " 4 $\frac{1}{4}$ "	" "	Square "	Round "	Square Hex.	- $\frac{3}{8}$ "	80 lb. K.
4 $\frac{1}{8}$ "	"	Cup	Square	"	-	90, 96 & 102 lb. B.S. Tram
3 $\frac{3}{4}$ "	"	"	Oval	"	$\frac{3}{8}$ "	92 lb. Tram

- a. Supplied with a Surpllice & Faram design B nut.
- b. Supplied with plain, Ibbotson designs A & B, Ureka, Lange's, Helicoid, or Surpllice & Faram design A, hexagon nuts.
- c. Supplied with 2 square nuts or an Ibbotson nut.
- d. Supplied with plain hexagon, Ibbotson square or a Ferguson square nut.
- e. Supplied with 2 square nuts.

PRESENT STANDARD FISHBOLTS						
LENGTH	DIA-METER	SHAPE			WASHER	USE: (TYPE OF FISHPLATE)
		HEAD	NECK	NUT		
4 $\frac{1}{4}$ "	$\frac{7}{8}$ "	Cup	Oval	Hex.	$\frac{1}{4}$ "	60 lb. A.S. 1919,25 60 lb. N. 66 lb. E. & F. 1929 80 lb. A.S. 1921 60 lb. A.S. X.L.O. Heel 60 lb. A.S. Flat
4 $\frac{1}{8}$ "	"	"	Nib	"	"	60 lb. C. 60 lb. D. 1881, 89,93 66 lb. E. 1879(Heavy) 66 lb. F. 1886 70 & 78 lb. Stock
* 4"	"	"	Square	Square	"	61 lb. S.A.
* 3 $\frac{3}{4}$ "	"	Square	Round	"	"	75 lb. G. 75 lb. L. 72 lb. J.
* 3 $\frac{3}{4}$ "	"	Cup	Oval	Hex.	"	60 lb. Sec. 602
* 3 $\frac{5}{8}$ "	"	Square	Round	Square	"	66 lb. E. 1879(Light)
4"	$\frac{3}{4}$ "	Cup	Oval	Hex.	"	60 lb. A.S. 1921
* 3 $\frac{3}{4}$ "	"	"	Nib	Square	"	50 lb. A. & B. 57 & 58 lb. Stock
* 3 $\frac{5}{8}$ "	"	"	Oval	Hex.	"	60 lb. N.S.W.

* Available only from released material.

PRESENT STANDARD FISHBOLTS

LENGTH	DIA-METER	SHAPE			WASHER	USE:(TYPE OF FISHPLATE)
		HEAD	NECK	NUT		
6 $\frac{3}{4}$ "	1"	Hex.	Round	Hex.	$\frac{1}{8}$ " Flat	100-110 lb. Weld Repair Plates
6"	"	"	"	"	"	80 -90 lb. " " "
5 $\frac{3}{8}$ "	"	Cup	Oval	"	$\frac{1}{4}$ "(1944)	80/90 lb. A.S. 1925, 28, 35 94 lb. A.S. 1937
5"	"	"	"	"	"	100 lb. A.S. 1923 100/110 lb. A.S. 1925, 28 107 lb. A.S. 1937 94 lb. A.S. 1939
4 $\frac{1}{2}$ "	"	"	"	"	"	80 lb. 'O' 80 lb. A.S. 1915 100 lb. P. 100 lb. A.S. 1915, 21 80 lb. 'O' & A.S. Flat 90 & 110 lb. A.S. Flat 100 lb. P. & A.S. Flat 75 lb. H. & I. 1929 95 & 115 lb. Stock
* 4 $\frac{3}{4}$ "	"	Square	Round	"	"	100 lb. B.S.
4 $\frac{1}{2}$ "	"	Cup	Nib	"	"	75 lb. I. 75 lb. H. 1885, 88 86 lb. Stock 100 lb. M.
4 $\frac{1}{4}$ "	"	Square	Round	"	"	80 lb. K.
* 4 $\frac{1}{8}$ "	"	Cup	Square	"	-	90, 96 & 102 lb. Tram
3 $\frac{3}{4}$ "	"	"	Oval	"	$\frac{1}{4}$ "(1944)	92 lb. Tram

* Available only from released material.

ORIGINAL JUNCTION FISHBOLTS						
LENGTH	DIA-METER	SHAPE			WASHER	(Weights of Junctions)
		HEAD	NECK	NUT		
5 $\frac{3}{8}$ "	1"	Cup	Oval	Hex.	$\frac{3}{8}$ "	75 lb.H.-80 lb. A.S. 75 lb.H.-90 lb. A.S. *80 lb.'0'-90 lb. A.S. 80 lb.'0'-100 lb. A.S. *80 lb.A.S.- 90 lb.A.S. *90 lb.A.S.-100 lb.A.S. *90 lb.A.S.-110 lb.A.S. 100 lb.A.S.-110 lb.A.S.
5 $\frac{3}{8}$ "	"	"	"	"	"	60 lb. D. - 75 lb. H.
5 $\frac{3}{4}$ "	$\frac{7}{8}$ "	"	"	"	$\frac{1}{4}$ "	
5 $\frac{3}{8}$ "	1"	"	"	"	$\frac{3}{8}$ "	75 lb. H. - 80 lb. '0'
4 $\frac{3}{4}$ "	"	"	"	"	"	
5 $\frac{1}{8}$ " 'J'	"	Square	Round	"	"	80 lb.'0'-90 or 94 lb.A.S. 1940 " " - 107 lb. " " " A.S.- " " " 90 or 94 lb.-100 lb. " " " " 107 " " " " 110 " " 100 lb.A.S.-107 lb.A.S.
5 $\frac{1}{8}$ "	"	Cup	Oval	"	"	80 A.S.-90 or 94 lb.A.S. 1940 107-110 lb. " "
4 $\frac{3}{4}$ "	"	"	"	"	"	80 lb.'0'-100 lb. P. 80 lb. A.S.-100 lb.A.S.
4 $\frac{3}{4}$ "	"	"	"	"	"	60 lb. D.- 80 lb. '0'
5 $\frac{3}{4}$ "	$\frac{7}{8}$ "	"	"	"	$\frac{1}{4}$ "	60 lb. D.- 80 lb. A.S. 60 lb. A.S.-80 lb. '0'
5 $\frac{3}{4}$ "	$\frac{7}{8}$ "	"	"	"	"	60 lb. A.S.-80 lb. A.S.
5 $\frac{3}{4}$ "	$\frac{7}{8}$ "	"	"	"	"	60 lb. A.S.-66 lb. E. 60 lb. D. -60 lb. A.S.
4 $\frac{1}{4}$ "	"	"	"	"	"	60 lb. A.S.-70 lb. H.

* These Junctions have been superseded by Type 1940.

PRESENT STANDARD JUNCTION FISHBOLTS

LENGTH	DIA-METER	SHAPE			WASHER	(Weights of Junctions)
		HEAD	NECK	NUT		
5 $\frac{3}{8}$ "	1"	Cup	Oval	Hex.	$\frac{1}{4}$ " (1944)	75 lb. H. - 80 lb. A.S. 75 lb. H. - 90 lb. A.S. *80 lb. 'O' - 90 lb. A.S. 80 lb. 'O' - 100 lb. A.S. *80 lb. A.S. - 90 lb. A.S. *90 lb. A.S. - 100 lb. A.S. *90 lb. A.S. - 110 lb. A.S. 100 lb. A.S. - 110 lb. A.S.
5 $\frac{3}{8}$ "	"	"	"	"	"	60 lb. D. - 75 lb. H.
5 $\frac{3}{4}$ "	$\frac{7}{8}$ "	"	"	"	$\frac{1}{4}$ "	
5 $\frac{3}{8}$ "	1"	"	"	"	$\frac{1}{4}$ " (1944)	75 lb. H. - 80 lb. 'O'
4 $\frac{1}{2}$ "	"	"	"	"	"	
5 $\frac{1}{8}$ " 'J'	"	Square	Round	"	"	80 lb. 'O' - 90 or 94 lb. A.S. 1940 " " - 107 lb. " " " A.S. - " " " 90 or 94 lb. - 100 lb. " " " " 107 " " " " 110 " " 100 lb. A.S. - 107 lb. A.S.
5"	"	Cup	Oval	"	"	80 A.S. - 90 or 94 lb. A.S. 1940 107 " - 110 lb. " "
4 $\frac{1}{2}$ "	"	"	"	"	"	80 lb. 'O' - 100 lb. P. 80 lb. A.S. - 100 " A.S.
4 $\frac{1}{2}$ "	"	"	"	"	"	60 D. - 80 lb. 'O'
5 $\frac{3}{4}$ "	$\frac{7}{8}$ "	"	"	"	$\frac{1}{4}$ "	" - " A.S. " A.S. - " 'O' " " - " A.S.
5 $\frac{3}{4}$ "	$\frac{7}{8}$ "	"	"	"	"	60 lb. A.S. - 66 lb. E. " D. - 60 A.S.
4 $\frac{1}{4}$ "	"	"	"	"	"	60 lb. A.S. - 75 lb. H.

* These Junctions have been superseded by Type 1940.

INSULATED JOINT BOLTS						
LENGTH	DIA-METER	SHAPE			WASHER	USE (Weights of Insul.Joints)
		HEAD	NECK	NUT		
8"	1"	Hex.	Round	Hex.	a	110 lb. A.S. Steel Weber
7"	"	"	"	"	a	90 lb. A.S. " "
7½"	"	"	"	"	a	80 lb. A.S. " " 100 lb. A.S. " "
8½"	"	"	"	"	a	75 lb. H. Wood "
8¼"	¾"	"	"	"	a	60 lb. D. " " 66 lb. E.&F. " "
7½"	"	"	"	"	a	60 lb. A.S. " "
6½"	1"	"	"	"	b	100 lb. A.S. 4 Piece Channel 110 lb. A.S. " " " 100-110 lb. A.S. Junction
5¾"	"	"	"	"	b	80-90 lb. A.S. Junction
5½" 'I'	"	"	"	"	a	80, 90, 94 lb. A.S. 1939 100, 107, 110 lb. A.S. 1939 80-90 or 94 lb. Junction " 100-107 lb. " " 100-110 lb. " " 107-110 lb. " "

a. Supplied with 2 No. Flat M.S. Washers.

b. Supplied with 2 No. Flat M.S. Washers, 1 No. ⅜" Spring Washer.

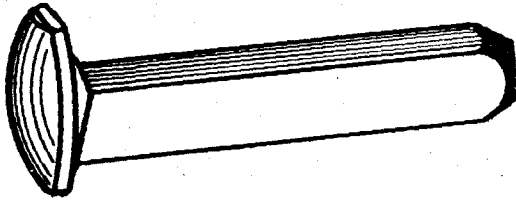

FIG. 1. STANDARD DOGSPIKE.

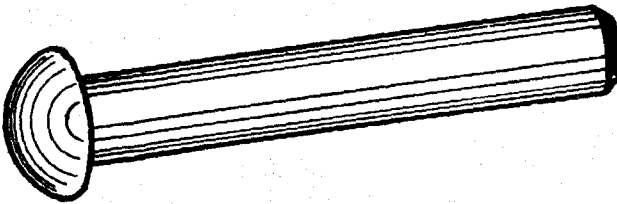

FIG. 2A. RAIL PIN.

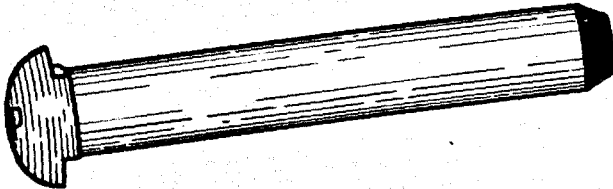

FIG. 2B. MARK 'P' RAIL PIN.



FIG. 3.



FIG. 4.

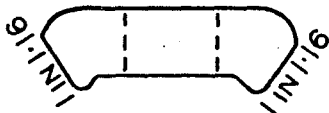

FIG. 5.



FIG. 6.

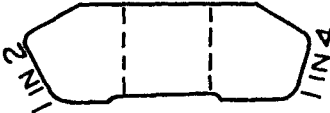

FIG. 7.

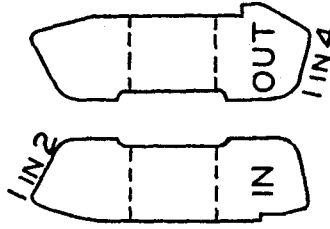

FIG. 8.

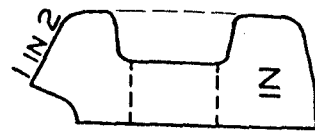

FIG. 9.

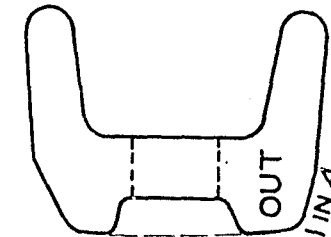

FIG. 10.

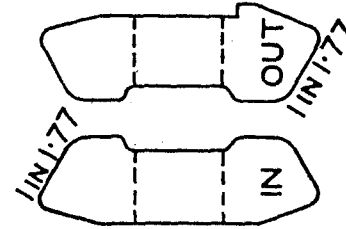

FIG. 11.

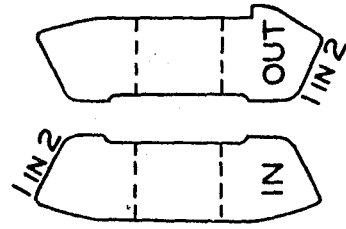

FIG. 12.

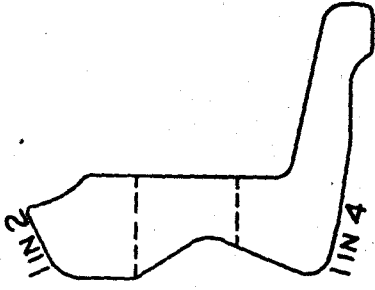

FIG. 15.

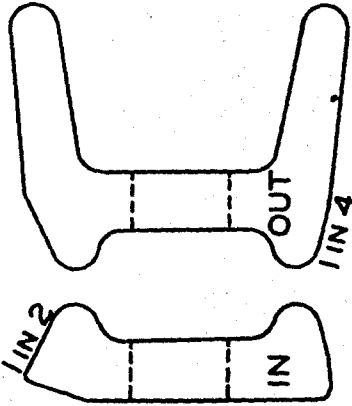

FIG. 14.

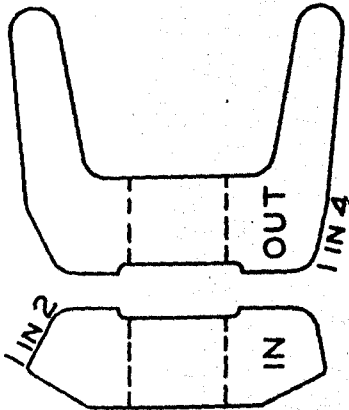

FIG. 13.

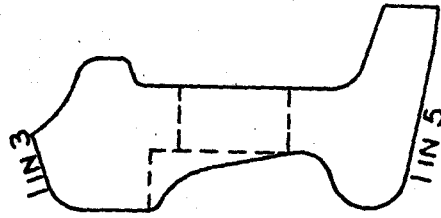

FIG. 21.

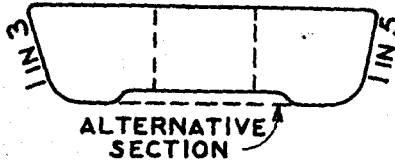

FIG. 20.

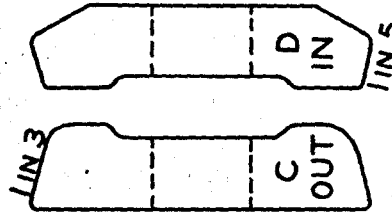

FIG. 19.



FIG. 18.

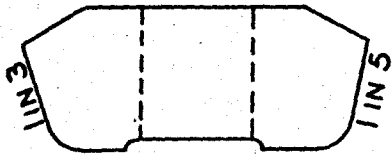

FIG. 17.



FIG. 16.

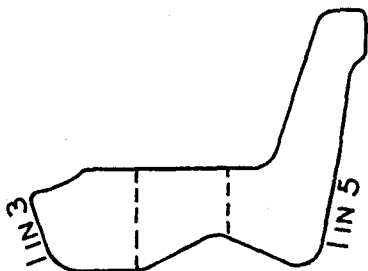

FIG. 24.

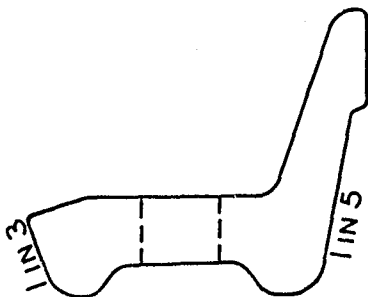

FIG. 23.

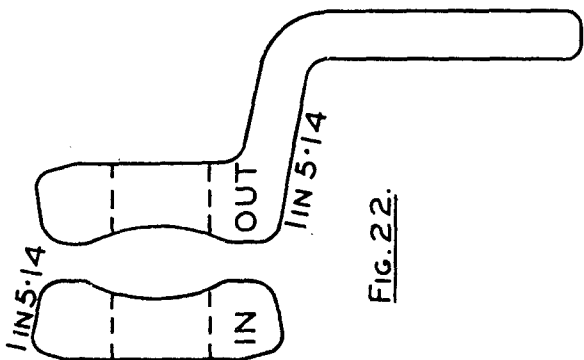

FIG. 22.

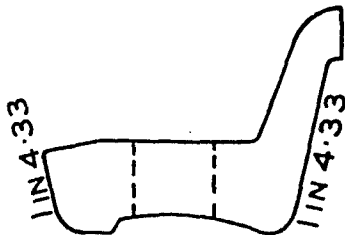

FIG. 25.

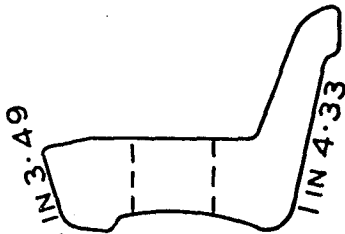

FIG. 26.

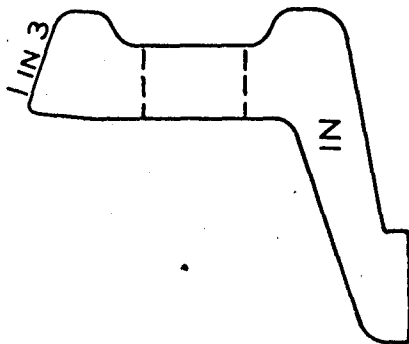
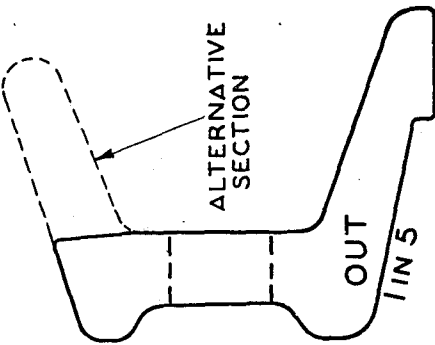

FIG. 27.



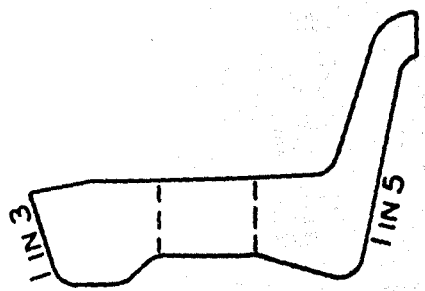

Fig. 28.

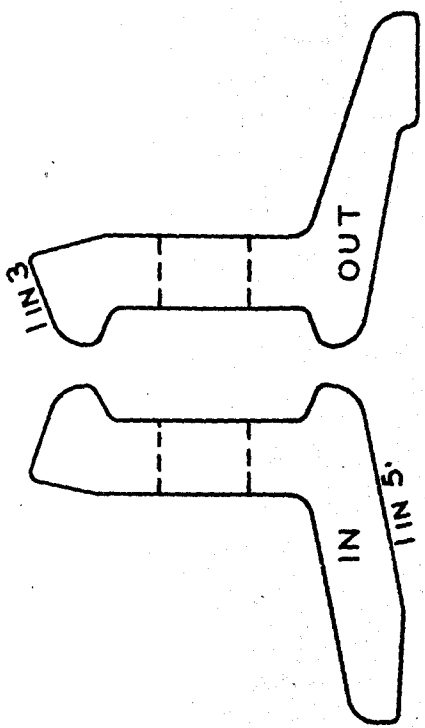

Fig. 29.

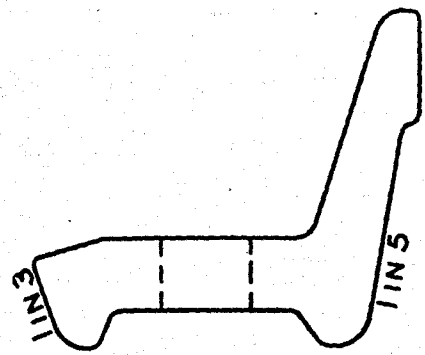

Fig. 30.

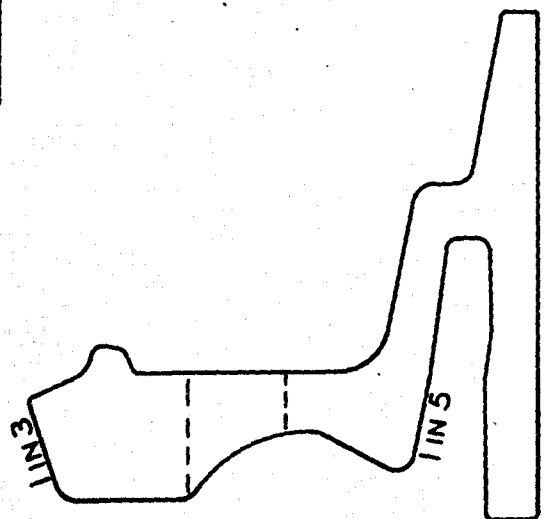

Fig. 31.

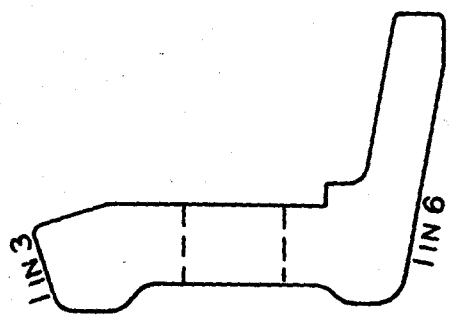

Fig. 32.

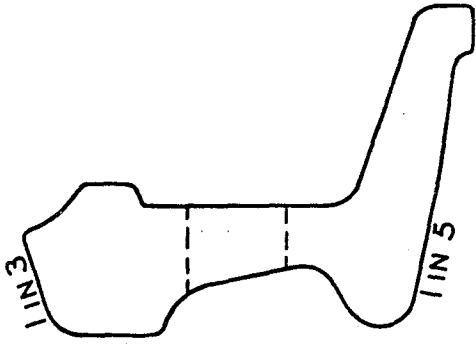

Fig. 35.

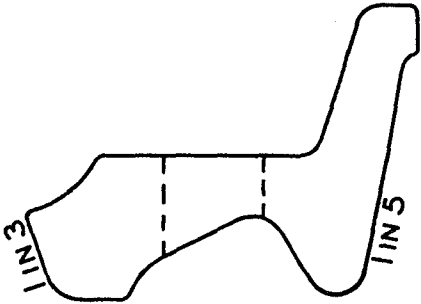

Fig. 34.

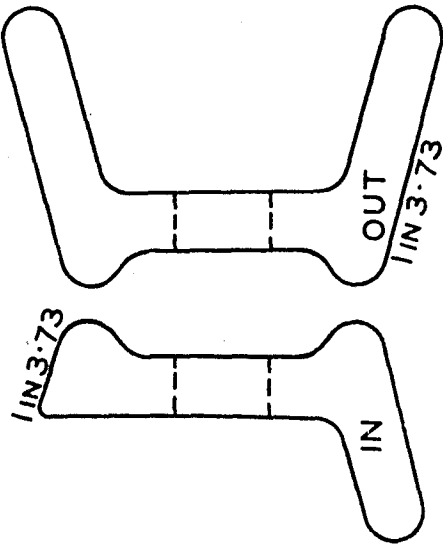

Fig. 33.

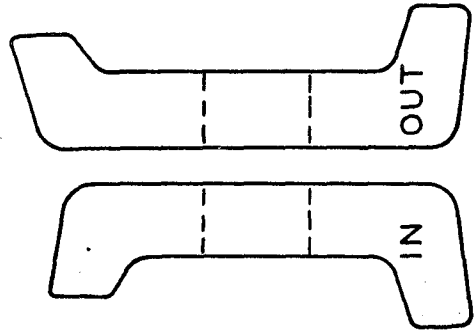

Fig. 39.

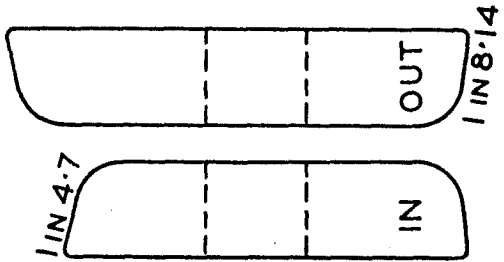

Fig. 38.

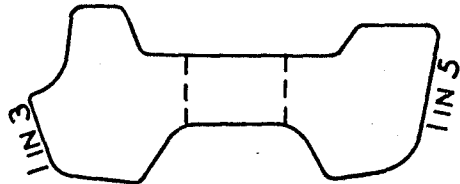

Fig. 37.

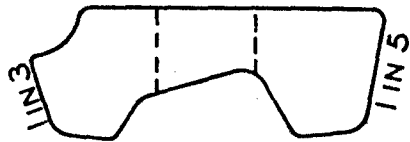

Fig. 36.

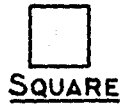
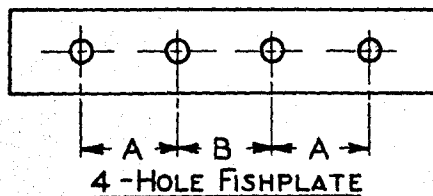
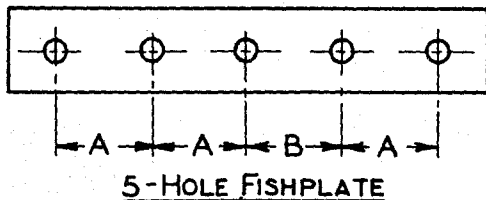
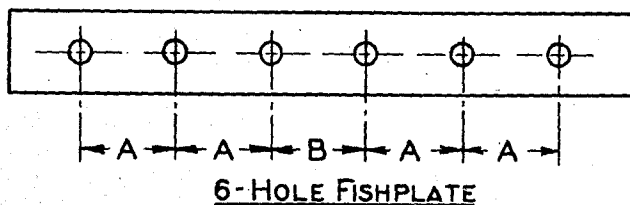

FIG. 40. SPACING AND SHAPES OF HOLES IN FISHPLATES. SEE TABLE 1.

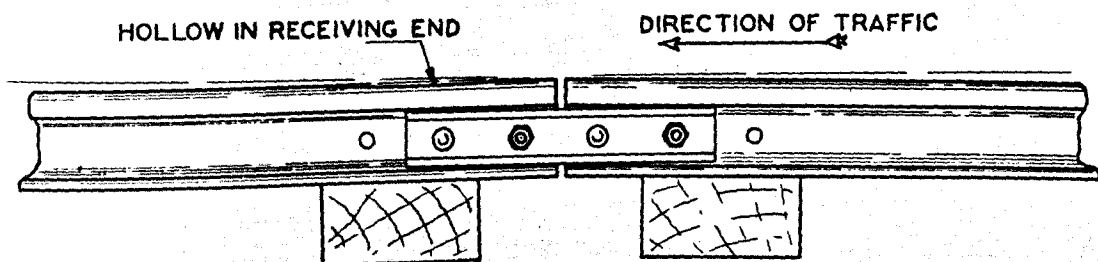

FIG. 41. UPWARD FLEXURE OF WEAK RAIL-JOINT.

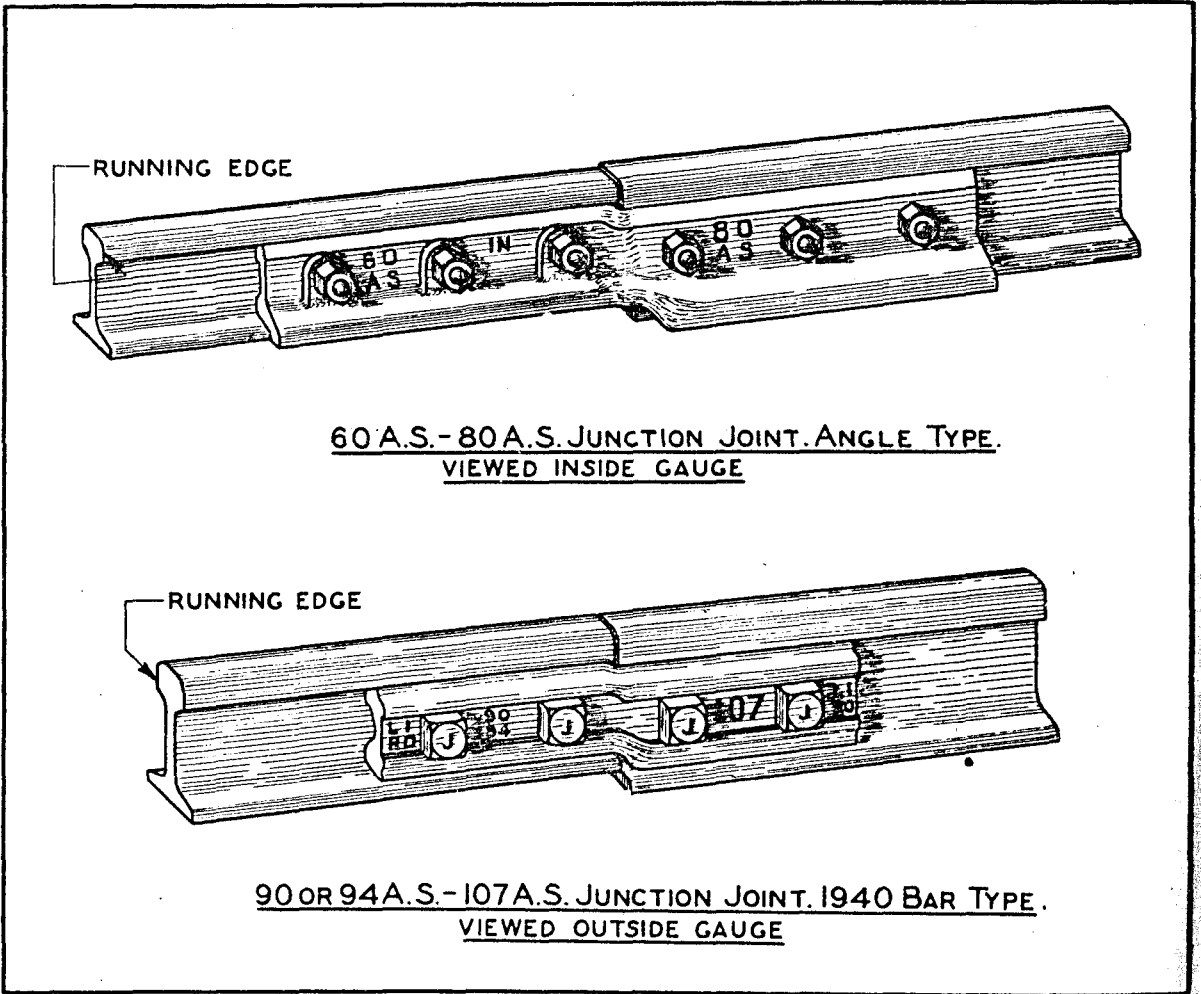

FIG. 42. TYPICAL JUNCTION JOINTS.

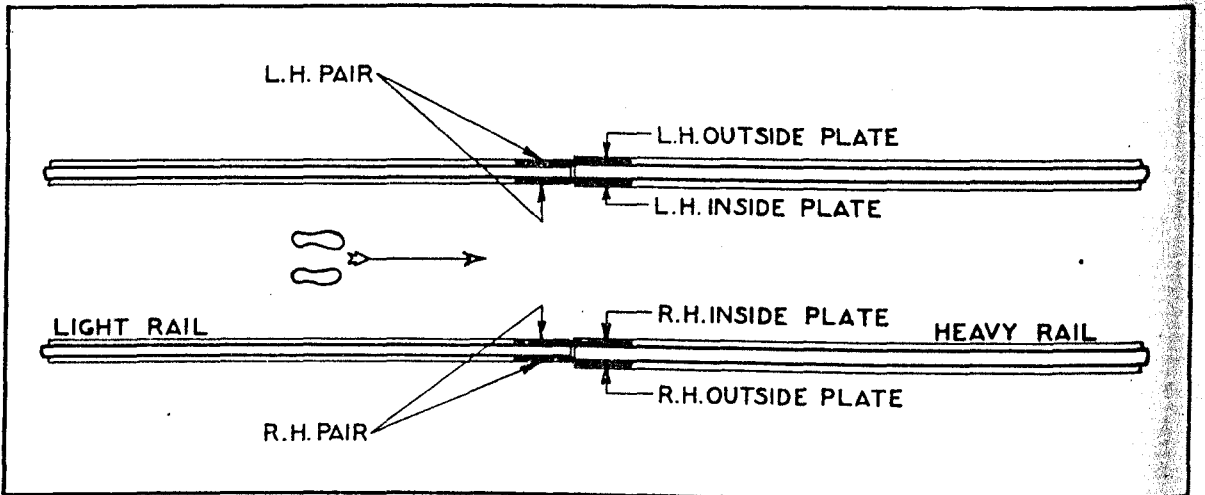

FIG. 43. METHOD OF DETERMINING HAND OF JUNCTION JOINTS.

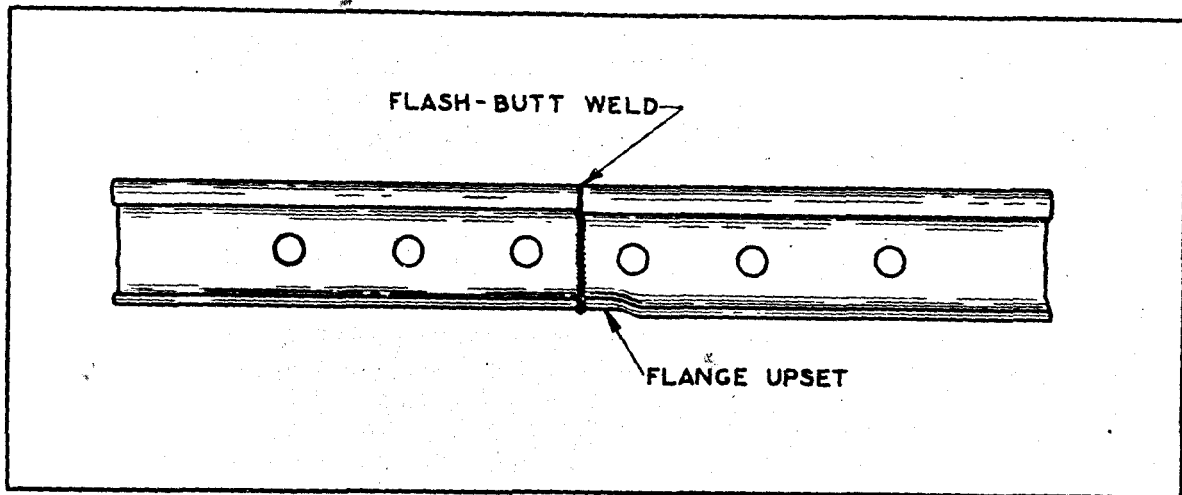

FIG. 44. WELDED JUNCTION RAIL.

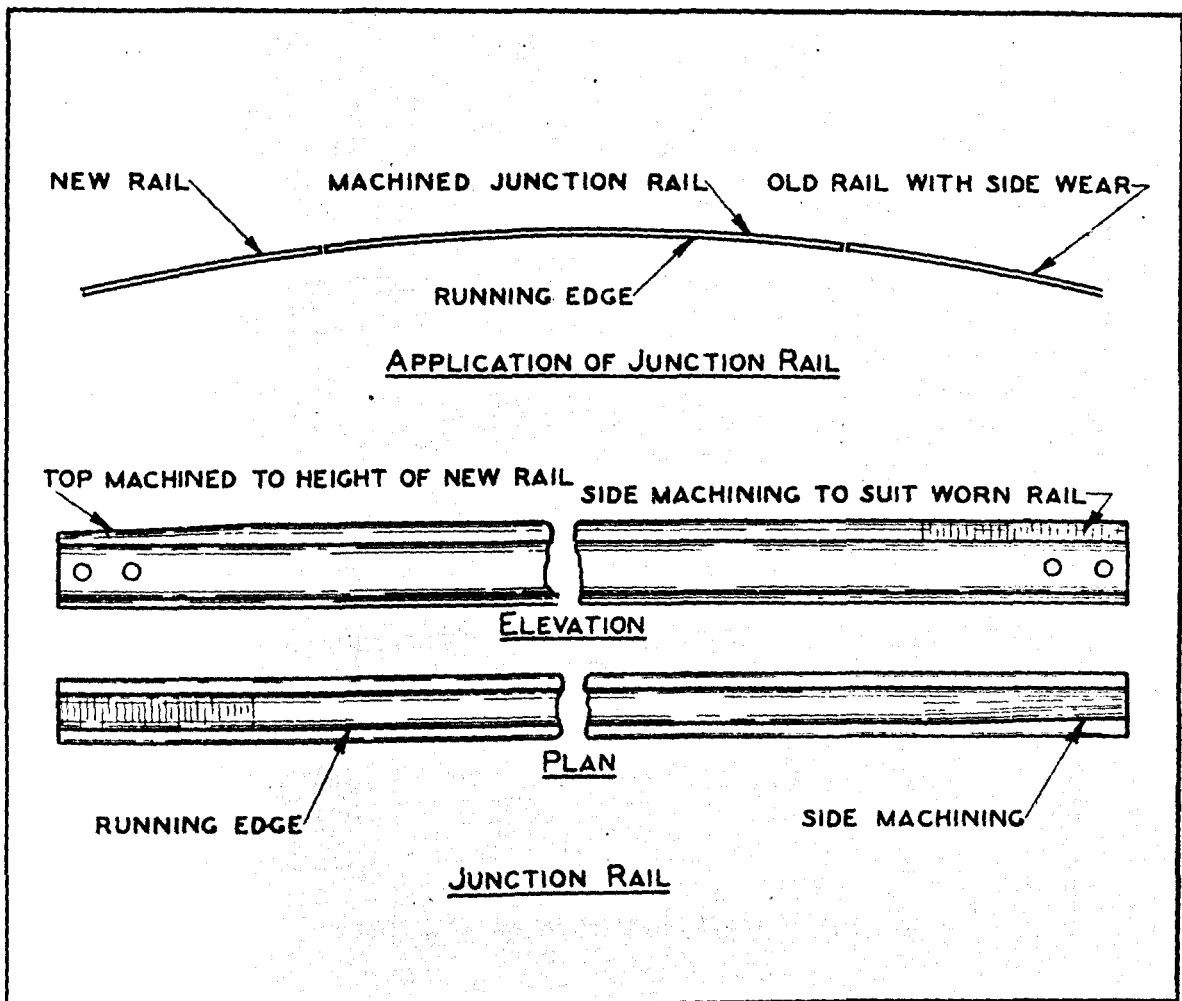

FIG. 45. MACHINED JUNCTION RAIL.

NOTE:- USE EXISTING BOLT HOLES WHERE POSSIBLE OR DRILL (AS AT 'A').
AT LEAST 2 BOLTS MUST BE USED, BUT PREFERABLY MORE.

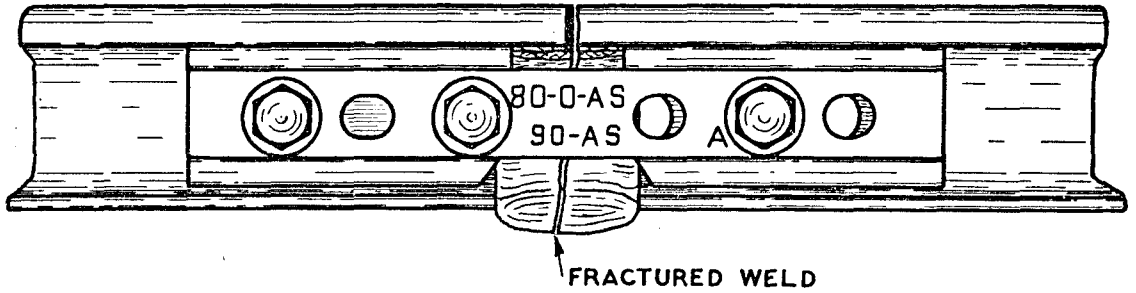

FIG. 46. REPAIR FISHPLATES — ON FRACTURED WELD.

NOTE:- INSULATIONS ARE SHOWN IN BLACK.

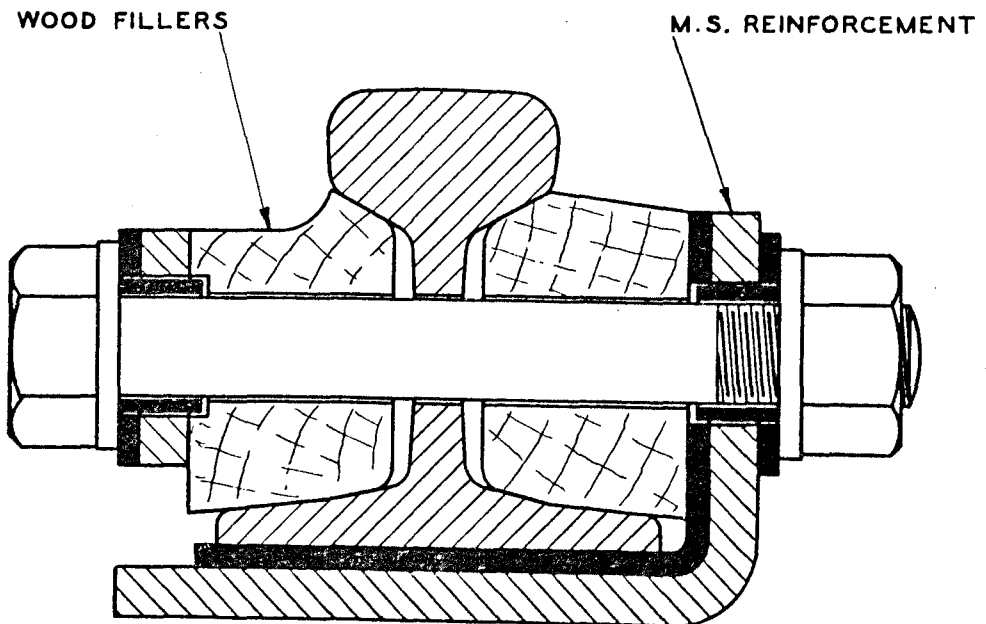

FIG. 47. TYPICAL WOOD-WEBER INSULATED JOINT.

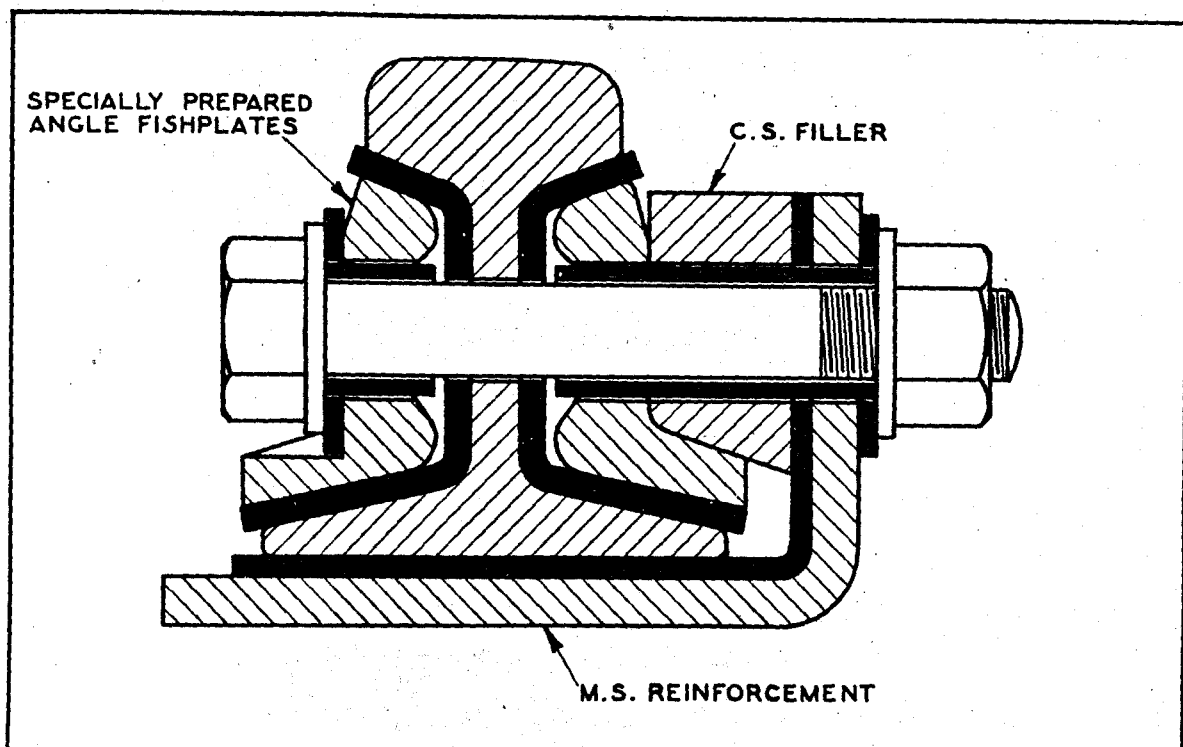

FIG.48. TYPICAL STEEL-WEBER INSULATED JOINT.

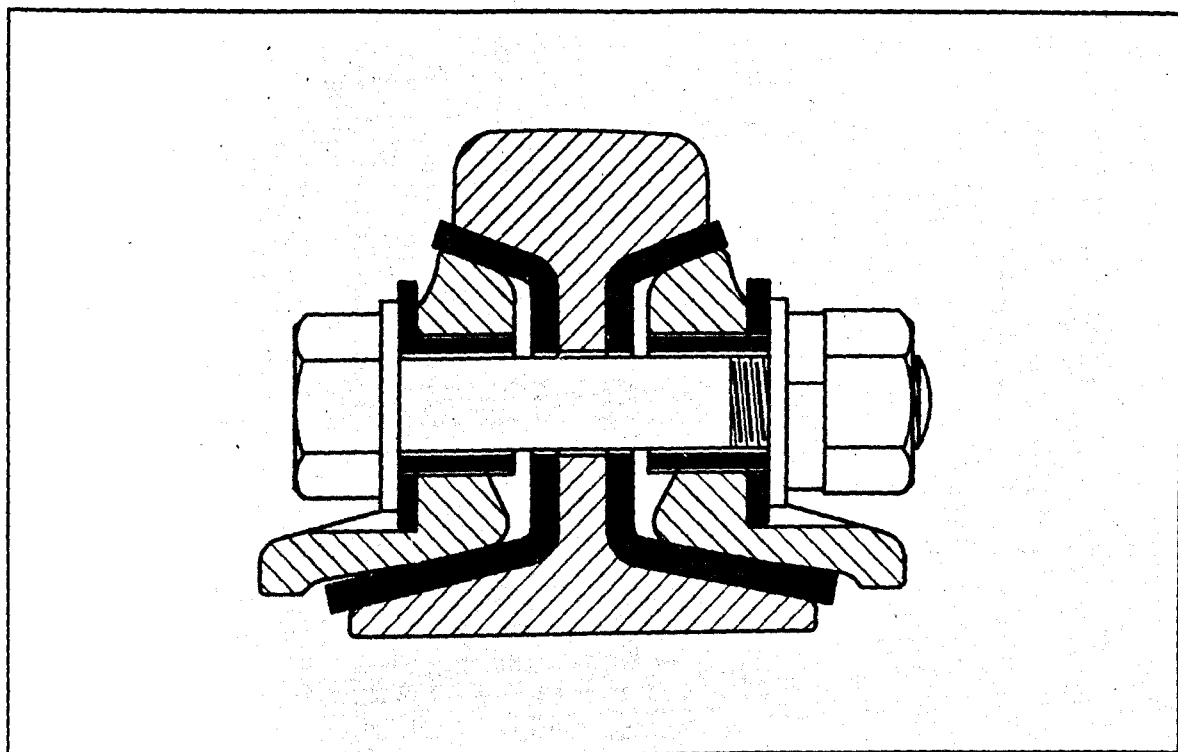

FIG.49. TYPICAL 4-PIECE CHANNEL TYPE INSULATED JOINT.

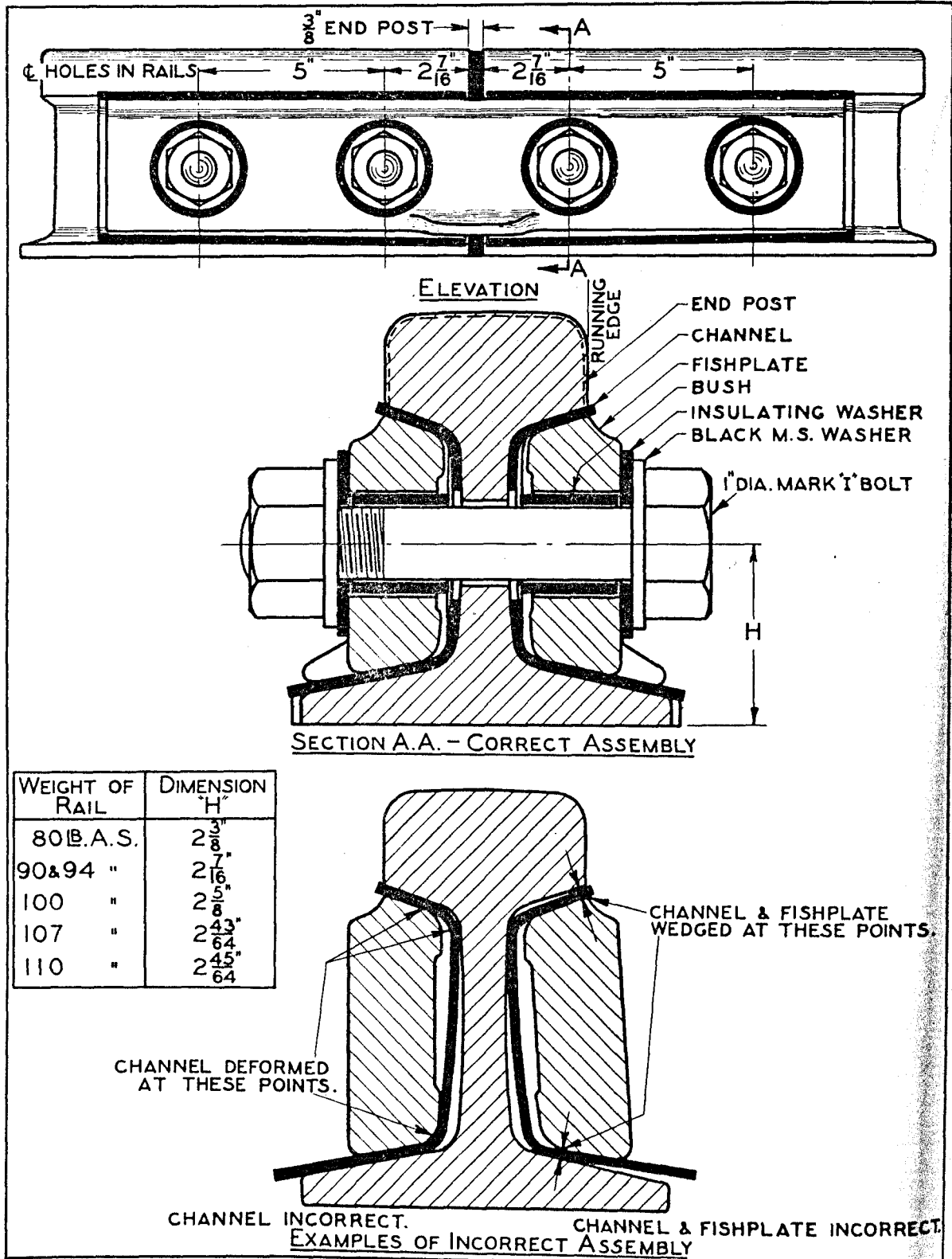

FIG. 50. TYPICAL TYPE 1939 INSULATED JOINT. METHOD OF ASSEMBLY.

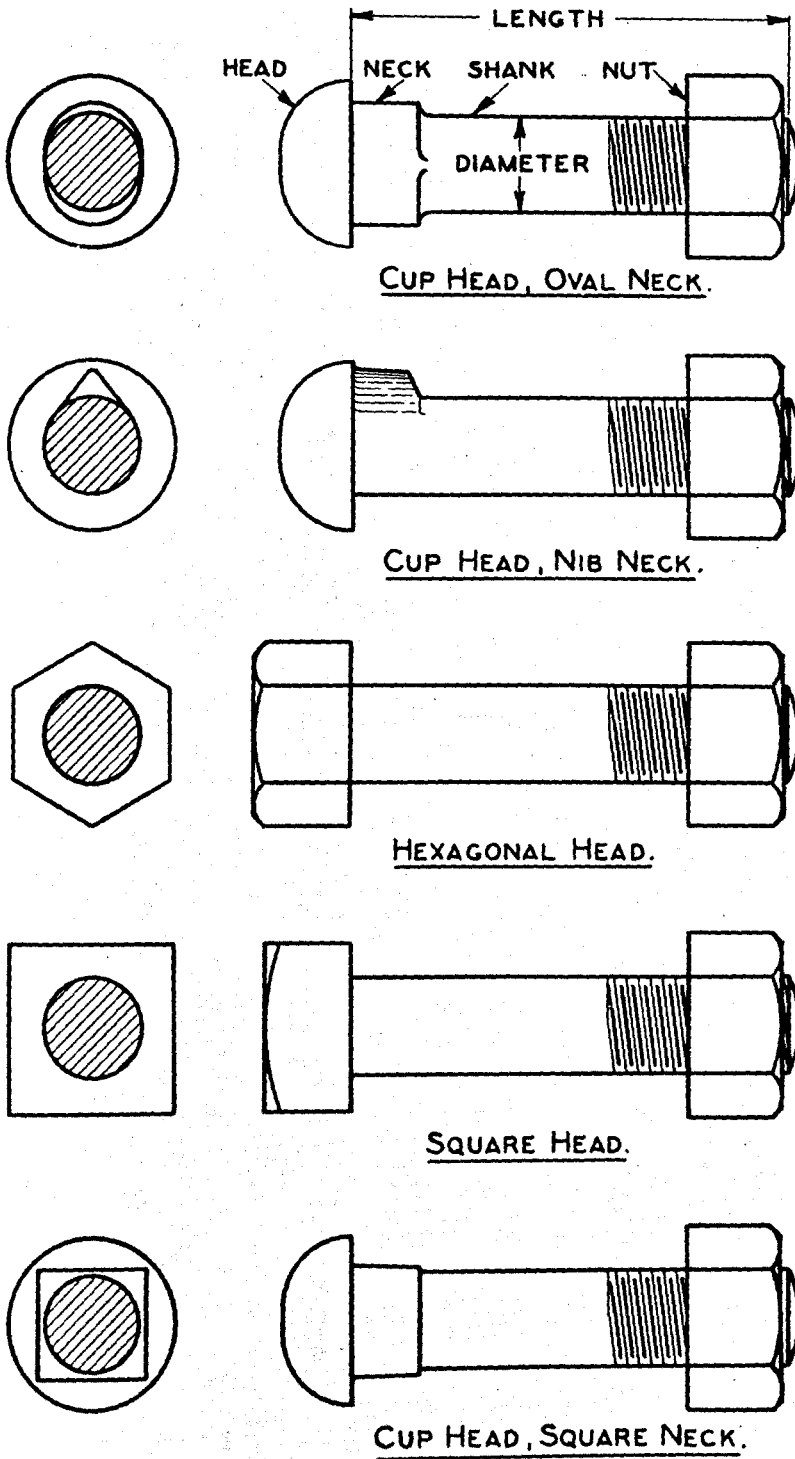

FIG. 51. TYPES OF FISHBOLTS.

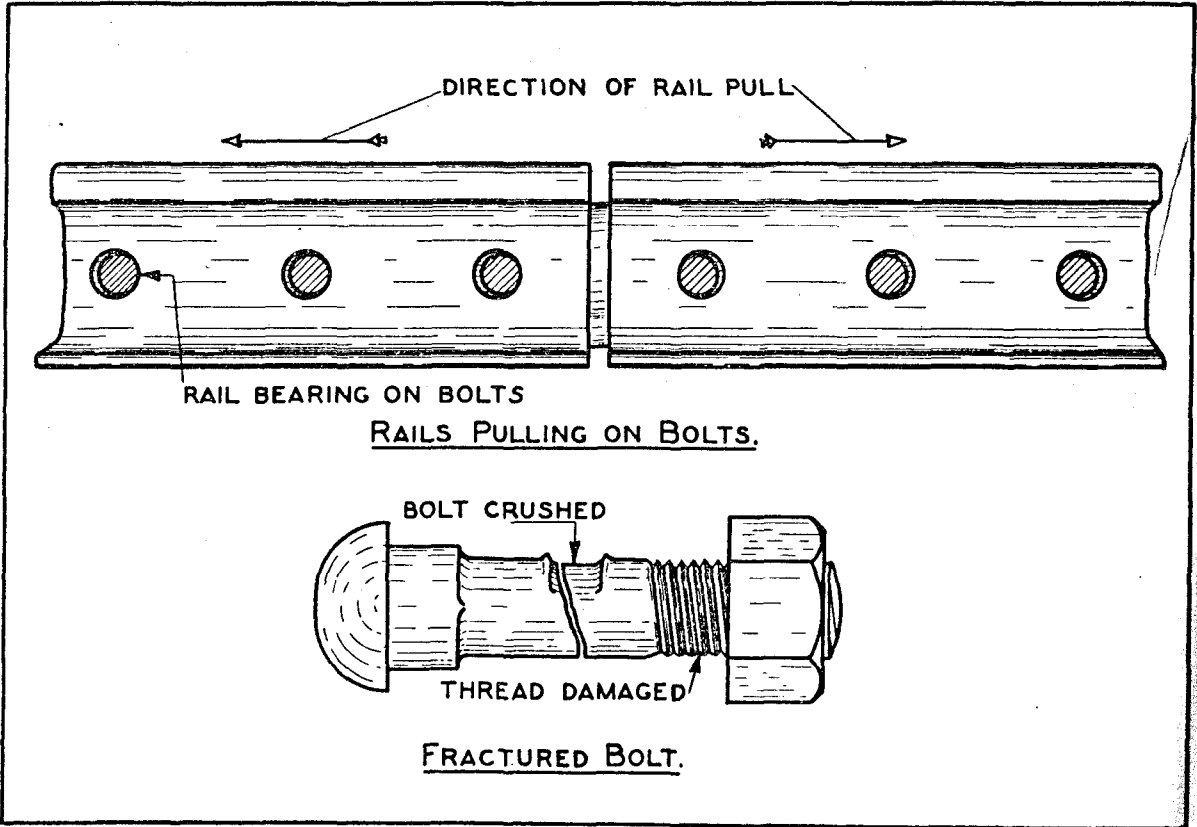

FIG. 52. FISHBOLTS FRACTURED BY PULLING RAILS.

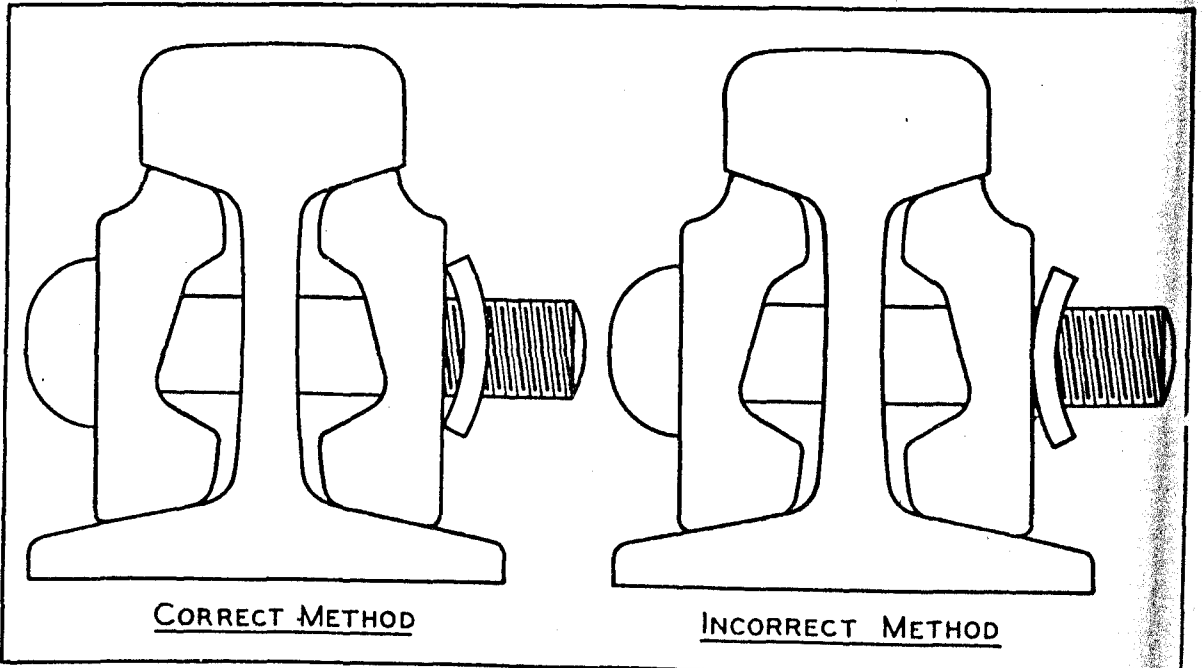

FIG. 53. APPLICATION OF TYPE 1944 SPRING WASHERS.

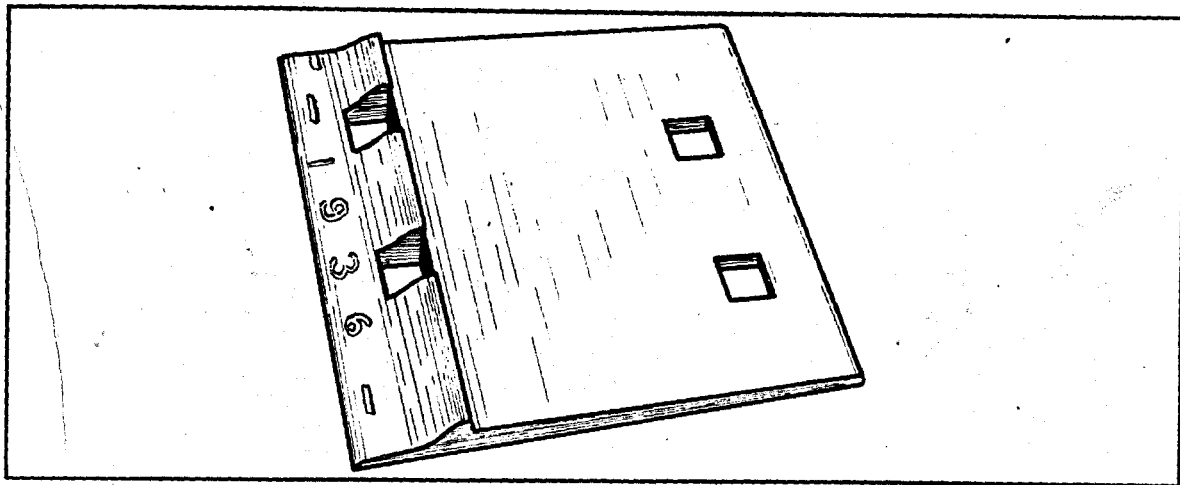

FIG. 54. SINGLE SHOULDERED SLEEPER PLATE.

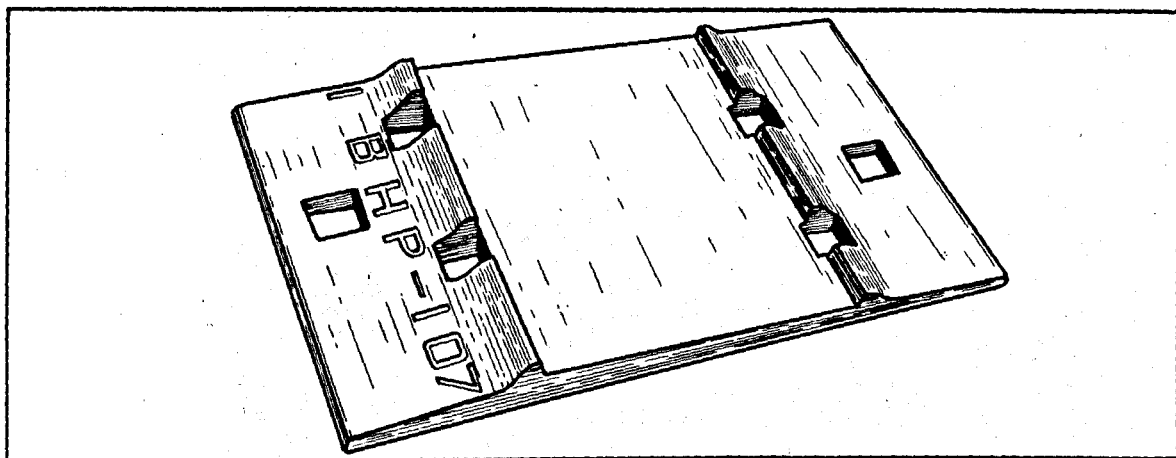

FIG. 55. DOUBLE SHOULDERED SLEEPER PLATE.

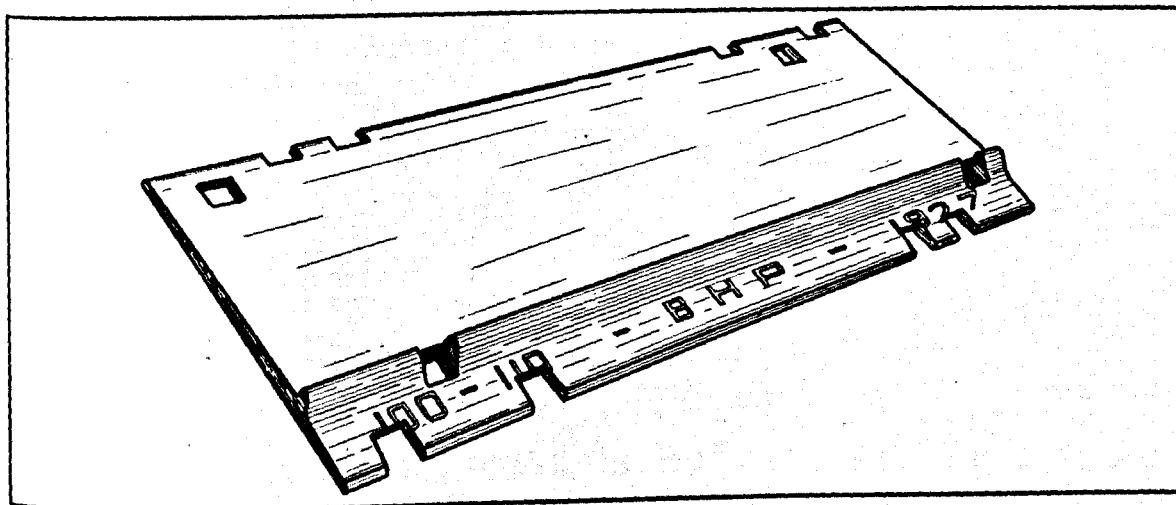

FIG. 56. BRIDGE PLATE.

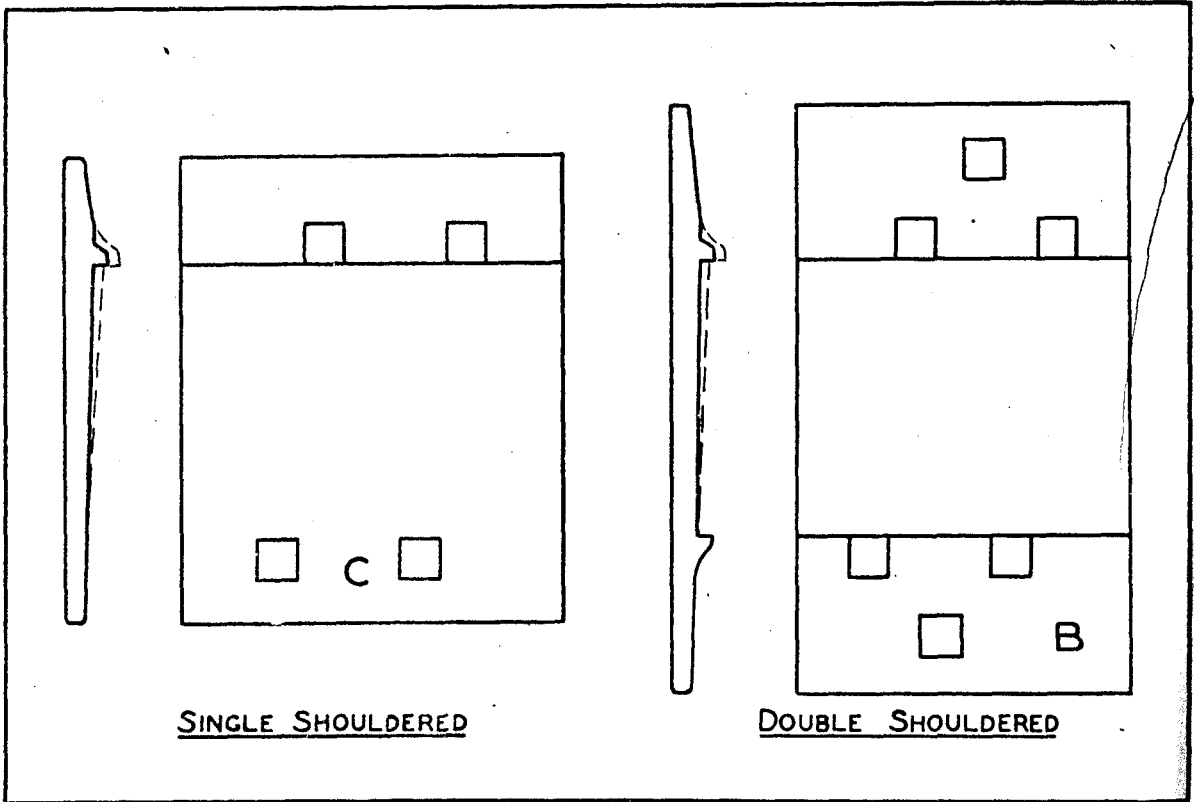

FIG.57. TYPICAL GRADUATED CANT PLATES.

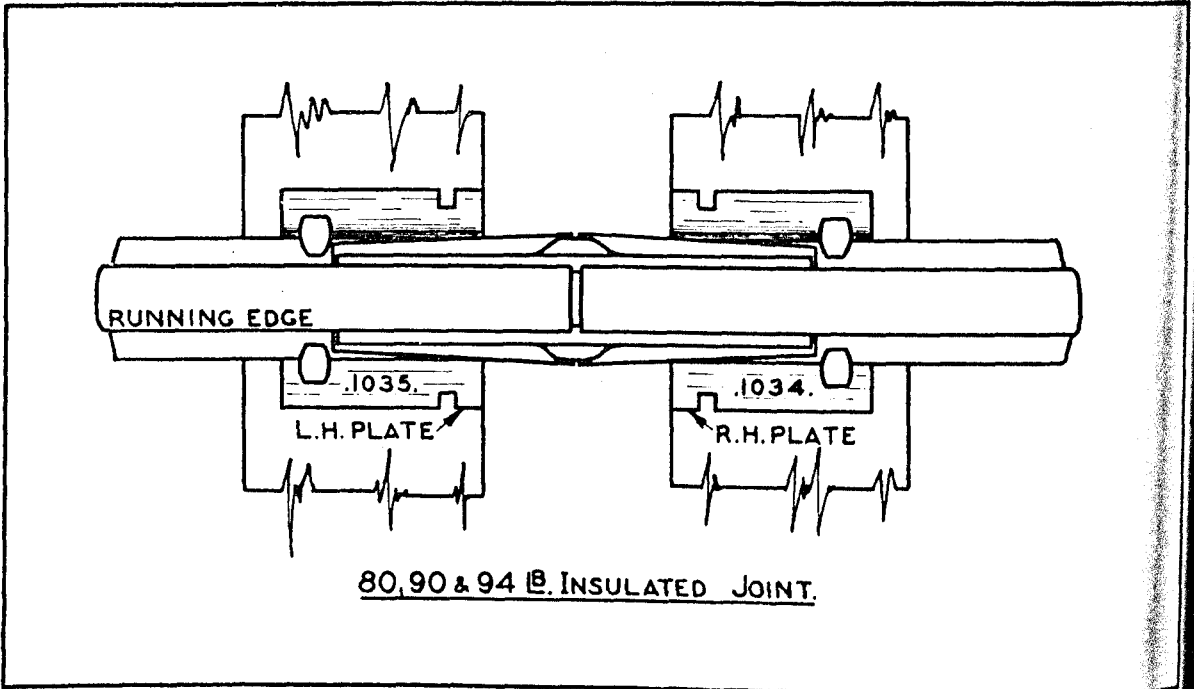

FIG.58. SLEEPER PLATES, 1 IN 20, FOR TYPE 1939 INSULATED JOINTS.

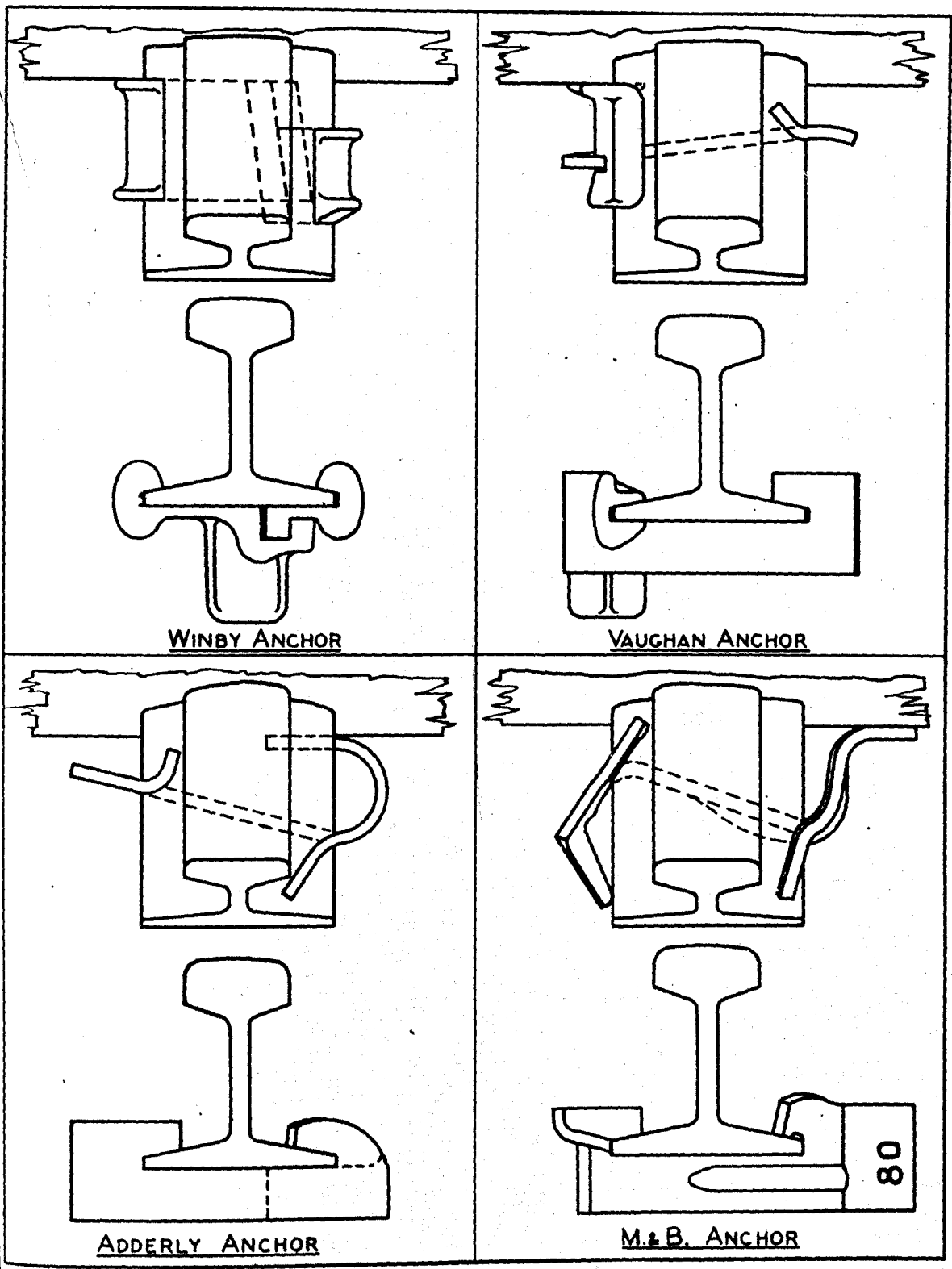

FIG. 59. RAIL ANCHORS, EARLIER TYPES.

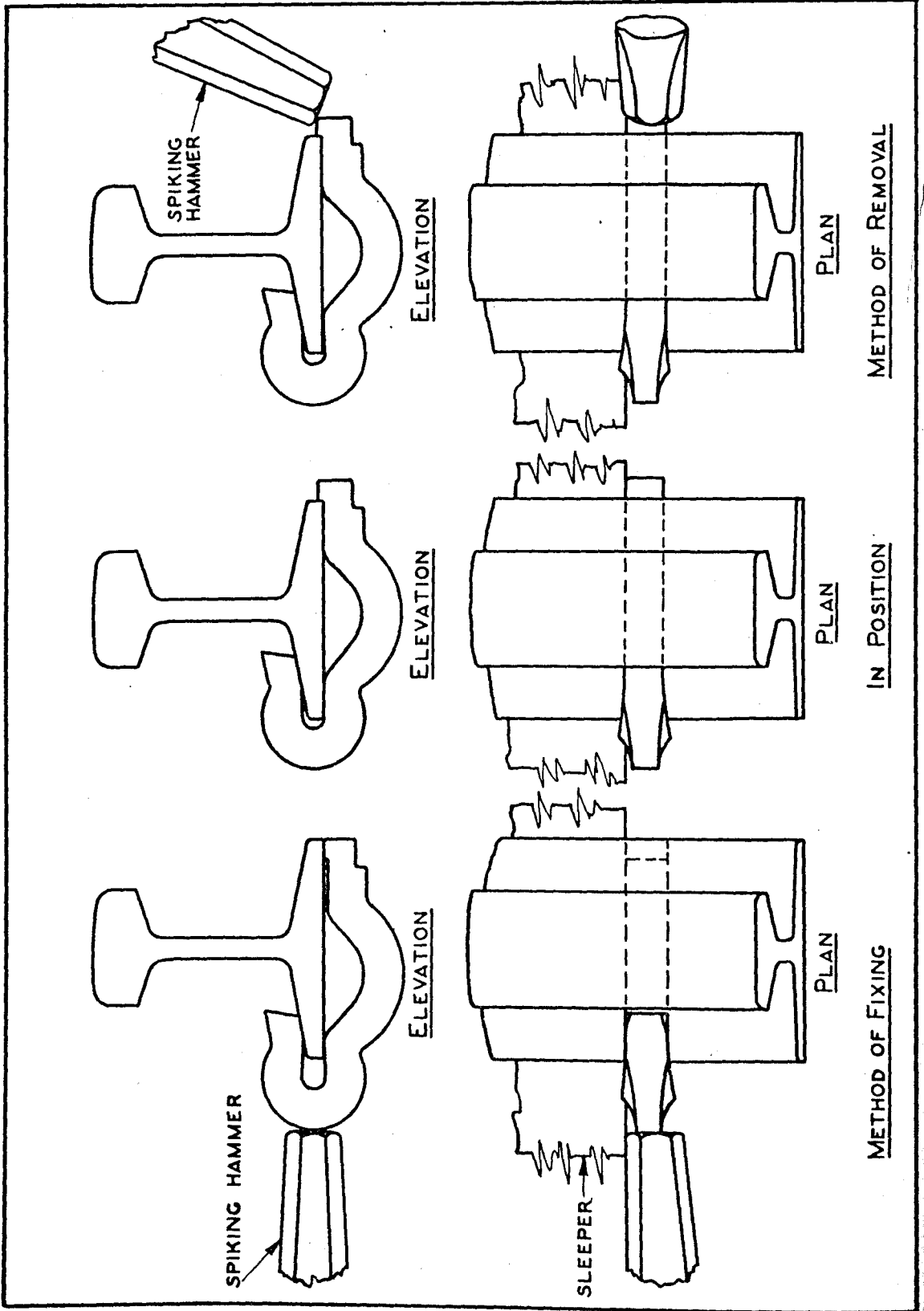

FIG. 60. FAIR RAIL ANCHOR. METHOD OF APPLICATION.

TRACK MAINTENANCE. II.

DEFINITION

Track maintenance refers to the work necessary to maintain the riding qualities of the track itself; this work comprises the routine corrections in surface, alignment and gauge.

The essential reason for all track repairs is to maintain a smooth surface for the passage of trains with comfort and safety. To achieve this objective the rails, joints, sleepers and fastenings must be kept in good repair. Thus the condition of the track in respect to its arrangement and the materials therein are interdependent; neither can exist alone in good condition for any length of time.

In other words, good surface, alignment and gauge cannot for long be maintained with bad rails, bad joints, etc., and conversely, good rails, good joints, etc., will be rapidly spoilt if surface, alignment and gauge are bad.

SURFACING TRACK

Surfacing is the operation of adjusting the levels of the track for vertical evenness on straight track, regular cant on curves and gradual variation of cant at the approach to and departure from horizontal curves. The adjustment of levels is made by lifting the track to surface and packing the space under the sleepers with ballast or screenings according to the method of packing employed.

Spot surfacing consists of lifting and packing isolated low spots. Out of face surfacing consists of working forward continuously on the full width of track from one point to another.

High and low are relative terms in respect to the general grade of the track, and as two rails are involved in the comparison it is usual to refer all levels to one of the rails described as the grade rail.

GRADE RAIL

On straight track the DOWN rail is regarded as the grade rail, but on curved tracks the INNER rail of the curve is the grade rail.

The levels of the opposite rail are adjusted with respect to the grade rail on straight track by the use of the straight edge and spirit level. On curved tracks the level of the outer rail is adjusted with respect to the inner rail by means of the cant board and spirit level, as shown in Fig.1.

The change of grade at about 25 or 50 feet in vertical curves is indicated by grade stakes when the curves are first set out, and at overway bridges and structures grade is indicated by rail level standards, as shown in 4.17, Fig. 26.

Over a period of years pegs become displaced or lost and all important track levels should be fixed by permanent monuments. In the absence of grade pegs the track must be surfaced by eye and in first class track maintenance the use of sighting boards and blocks is standard practice on most railway systems. See Fig. 2.

Adjustable sighting heads and targets have an advantage over the earlier fixed sighting boards and blocks in that the extent of the depression of the unloaded track can be read in dimensions or in terms of canisters of packing when measured packing is in use. See 11.05.

At the intersection of grades the target should not overlap the point of grade change. On a falling grade this would result in a reduction of ballast at the point of grade change. See Fig. 3. On a rising grade the opposite effect would occur, as shown in Fig. 4.

When vertical curves are met with every care must be taken to avoid running the grades beyond the ends of the curve, as the rate of change of grade would thereby be seriously affected and the whole purpose of the vertical curve would be defeated. See 3.22.

The general method of surfacing the rail by eye alone has many disadvantages, being influenced by the condition of the rail, the intensity and direction of the light, shadows on the rail, and alignment of the rail.

Surface of track under no load gives no true indication of the cavities between the undersides of the sleepers and the ballast. The only possible way of ascertaining what cavities exist is to observe the depression of the rail under traffic, and on first class track this can best be done by self-recording instruments. See 11.05.

LIFTING TRACK

Lifting is now generally done with the aid of track jacks, and if surfacing is out of face the lifting should be done against the direction of traffic on double track and against the direction of the fastest traffic on single track.

The jacks should be put in from outside the gauge as they are easier to insert and can be removed quickly, if necessary, from this position. Care should be taken to properly bed the jack before commencing the lift or the jack may slip, and if the lift is not vertical the track may be thrown out of line.

When lifting is done in station pits the jacks on the platform side may require to be inserted within the gauge and suitable protection of the track must be arranged before putting the jacks into position.

The difference in surface between sections of track during lifting operations necessitates the introduction of temporary ramps or runouts.

RUNOUTS

Impact of the trains on the track is much less severe running on to an ascending grade than when running off a descending grade; if lifting is 'against' traffic the runout is always 'ascended'. On single tracks the lift should be made 'against' the direction of the fastest traffic. On steep grades the lift should be made 'up' the grade.

Runouts should be graded according to the speed of traffic on the track, a safe rule being to grade at the rate of 1 inch in a number of feet equal to the speed of the fastest train in miles per hour.

Example : - Speed of fastest train = 30 m. p. h.
 Grade of ramp = 1 inch in 30 feet.

For the average speeds on country lines 3 inches in 20 yards (1 inch in 20 feet) is usually adopted, but this is too steep for main tracks unless speed restrictions are imposed.

On high speed tracks, where the work required in preparing the necessary length of runout for a 3 inch lift would be considerable, it is generally advisable to impose a speed restriction and construct a suitable runout for the reduced speed. See 3.06.

At the ends of runouts care must be taken with the packing, particularly at the junction with the undisturbed track, as the sleepers for some distance are slightly sprung from their beds. Packing under these circumstances must be done with the beater, and the old beds should be cracked by driving the point of the beater well in under the sleepers before packing is commenced.

SPOT SURFACING

The lift in spot surfacing should not be too great otherwise damage will be done to the rails and fishplates. Spikes may be started from the sleepers and adjacent sleepers be sprung from their beds with the possibility of ballast fretting in and interfering with re-bedding of the rail on the sleepers and of the sleepers on their ballast beds.

Cross lifting in spot surfacing can also result in end bound sleepers under the opposite rail, as the sleeper is sprung from its bed and rests only on the out end. End bound sleepers tend to 'dish' the track and close the gauge and may break at the rail seat if left for long in this condition.

As the space under an end bound sleeper is very small, packing is usually only effective at the edges of the sleeper; it is therefore preferable to break up the sleeper bed with the sharp point of the beater before commencing to pack.

It is a mistake, when lifting a low joint, to lift above the proper level with a view to settlement. A joint packed too high will settle more under traffic than if it were packed to its true level and while so doing will make bad running on the track.

The remedy for a joint which settles after being lifted is to give it another lift and better packing, or to search for and rectify the cause of the persistent settlement.

OUT-OF-FACE SURFACING

For surfacing out of face, several sets of track jacks may be in use and, if the lifts are taken evenly, the danger of kinking the rails at the joints is less than when working with a single pair of track jacks.

With three sets of track jacks in use the leading set should lift the joints and intermediate points according to the length of rail. If the lift required be 3 inches, the leading set should lift about $2\frac{1}{2}$ " and shovel pack sufficiently to hold the track.

The second set should rough surface the track to cross level and grade leaving uniform packing for the third set, as it not infrequently happens that ballast may be found somewhat scant to complete the packing. Final surfacing and packing is done by the third set.

With two sets of jacks in use the leading set should take rather more than half the lift and rough surface the track to cross level and grade.

Final surfacing and packing is done by the following set.

Before the extent of the lift is decided on, it should be clear that sufficient ballast is in track or on hand to properly pack the lift and provide the necessary boxing to hold the track in line. If insufficient ballast is available to fully box the track to the ballast profile, the centre should be left hollow and the available ballast be concentrated at the shoulders.

CENTRE BOUND TRACK

When strong gravel ballast is in use a condition may arise where the surface and alignment are good but the track tends to rock under traffic. This condition is known as centre bound track and a light out of face or running lift is required to raise the track off the old bed and restore elasticity.

If additional ballast is not available the centre ballast should be gulletted out and used in the packing areas and towards the out ends of the sleepers to help hold the track in line. Gulletting is not advisable in station yards or on bridges and is not permitted in welded track.

VOIDMETERS

Voidmeters are used on British and Continental Railways to indicate the depression of first class track under traffic and the Department has recently obtained some of these instruments shown in Fig. 5.

The surface is sighted by a target and sighting heads as shown in Fig. 6, and the sleepers are sounded for looseness and marked with raddle. Voidmeters are placed at intervals along the track, one at the centre of each group of loose sleepers. On curves all the voidmeters are applied on the inner rail.

The voids are registered on the voidmeter scale in terms of the number of canisters of screenings required to fill the packing space under the sleeper, and the reading is marked on the sleeper.

Screenings required for adjusting sleepers are estimated as follows : -

1. The static depression of the track is measured by the use of the sighting heads and target on the rail, as shown in Fig. 7.

2. The depression of the sleepers under traffic is recorded on a series of voidmeters, as shown in Fig. 8.
3. The correct amount of screenings is determined by adding together the readings of the sighting heads and the voidmeters to ascertain the number of canisters of screenings required to adjust the surface of the track.
4. The track is lifted and the screenings are inserted under the sleepers and spread evenly over the bed by means of the long trowels provided or by means of side set spades as shown in Fig. 9.

To estimate the screenings required under intermediate sleepers the number of canisters is decreased proportionately to the distance from the point of maximum track depression.

The system is regarded by British Railway Engineers as being very suitable for first class tracks with broken stone ballast, or slag, but unsuitable when the ballast consists of earth, sand, ashes, or a mixture of round gravel and sand, or where pressed steel sleepers are in use, or where soft spots exist owing to bad drainage.

MEASURED PACKING

Measured packing is the method in use whereby the necessary screenings are placed under depressed sleepers to re-surface the track.

The required quantity of screenings is first ascertained by the use of the sighting boards, or targets and voidmeters, and marked in raddle on the out ends of the sleepers.

To give access to the sleeper beds the out ends are cleared of ballast or one side of the packing area opened out according to the amount of packing required, but the sleeper bed is not disturbed.

The track is lifted and the screenings, measured out by canisters, are inserted with the trowel and strewn evenly over the bearing area of the sleeper bed. All screenings must be perfectly dry or they will bind together and not spread evenly. After removal of the jacks the ballast is boxed up and trimmed to ballast profile.

SHOVEL PACKING

Prior to the development of voidmeters a system of packing the voids beneath loose sleepers without disturbing the sleeper beds had long been in use on the British and Continental Railways, but the effectiveness of the work depended upon the trackmen's ability to estimate the quantity of screenings to be inserted by a special flat shovel.

This system is known as shovel packing and is reasonably effective provided the condition of the road bed is solid and properly drained at all seasons of the year. Shovel packing as here described should not be confused with ordinary shovel packing performed with a loose ballast bed when the ballast is forced under the sleepers with the lip of the shovel.

BEATER PACKING

The most usual form of packing by hand tools is beater packing, and for this operation the boxing ballast must be cleared from both sides of the sleepers to enable the packing to be driven under the sleepers.

If the sleepers have been treated extra care must be taken to prevent damage at the edges, in any case, rounding of the lower corners of the sleepers owing to careless beater packing tends to cause the sleepers to roll under traffic.

In beater packing, two men should work together facing each other, one on either side of the rail, reversing their positions as the packing proceeds and thereby evenly packing the sleeper. For safety no one should be permitted to pack in the adjacent sleeper spaces, and therefore the pairs must be spaced out at least 3 spaces apart.

Good packing can be recognised by a dull, but not hollow, sound when the beater is used as a ram on the surface of the sleeper, but a man of experience can tell if the packing is sound by walking the sleepers on the out ends.

MECHANICAL PACKING

Power operated mechanical packing appliances of several types are in use, being operated by compressed air or internal combustion units. See 15.07.

Mechanical packing was developed in U.S.A., and the American term 'tie tamping' is the equivalent of sleeper packing. In operation the tie tampers are used in pairs, the men packing both sides of the sleepers simultaneously.

With mechanical packing, damage to sleepers is reduced, but the ballast is broken up to a greater extent than by beater packing. There is also a greater tendency with shallow ballast beds to drive the ballast into the formation thus forming water pockets. If used for packing gravel ballast a wider tamping blade is required than that used for metal ballast.

Ballast need not be cleared aside for mechanical packing, but if compacted it should be loosened up at the edges of the sleepers by means of picks.

Mechanical packing tends to lift the track beyond the jack lift and in course of time the limits of structural clearances may be infringed. It is possible to over-pack with mechanical equipment, and if this is done it becomes a difficult matter to again lower the track.

Provided the drainage is properly arranged a considerable improvement in the stability of trackwork can be achieved by mechanical packing of the timbers under trackwork layouts, particularly under and adjacent to the points and crossings.

JOINT PACKING

Joint sleepers should be packed from both sides, and with close spacing this necessitates driving the ballast under the sleepers at an angle to enable the beater to clear the joint sleeper. If the packing is concentrated on one side of each joint sleeper, the joint will tend to dip as shown in Fig. 10.

ALIGNMENT

After the track has been surfaced and before boxing up and trimming to ballast profile is commenced, the alignment of the track must be carefully adjusted. This work can only be done satisfactorily when the surface of the track is true and correct, and this condition is more likely to obtain immediately after surfacing and before the passage of trains.

To satisfactorily align the track the conditions of light must be suitable, such as that obtaining about noon-day in a lightly clouded sky when there is an absence of glare and the temperature is moderate.

It is more difficult to line up track when the temperature is rising as the rails are expanding and tend to buckle the track. With short rails the expansion spaces at the joints should compensate for the expansion, provided the joints are free to allow the necessary longitudinal movement.

Track laid with long welded rails is not, of course, opened out for surfacing and lining during hot weather because of the danger of buckling.

The true centre line position of straight track may be located from the clearances at bridges, station platforms, level crossings, and culverts.

When the alignment is being corrected the track should be sighted at some distance from the point requiring re-alignment, and preferably from a high point, such as an overway bridge, as the nature and extent of the re-alignment will be more noticeable under these conditions.

If a break in the perfect alignment of straight track is unavoidable it should be arranged, both for appearance and safety, at the summit between two grades. It is bad practice to break the continuity of alignment in a depression at the foot of intersecting grades.

The alignment of curved track is taken from the centre pegs to the running edge of the outer rail; this distance measured from the nail in the centre peg to a point $\frac{3}{8}$ " below the running surface on the running edge of the rail is 2'7 $\frac{1}{2}$ " on 5'3" gauge and 1'3" on the 2'6" gauge.

In the absence of all or any of the centre line pegs the regularity of curvature should be checked by the methods described in 3.25.

ALIGNING RAIL

On straight track the DOWN rail is regarded as the line rail and the UP rail as the gauge rail.

On curved track the OUTER rail is the line rail and the INNER rail is the gauge rail.

Widening of gauge for sharp curvature should be done on the inner rail from the tangent point of the curve and be gradually run out on the straight track to gauge in a length of 25 feet.

LINING OPERATIONS

Lining is done with straight bars pointed at one end to enable them to be driven into and through the ballast to obtain the necessary leverage. See 15.05.

It is easier to slew the track if a slight lift is applied at the same time as the pulling, and the angle at which the bars are held should therefore be about 30 degrees, or 1 in 2.

When lining, the trackman should not straddle the lining bar, as this position may cause rupture, and in no case should two men attempt to pull on one bar.

The lining bars should never be left lying about as men are apt to trip over them and injure themselves; when not in use the bars should be driven vertically into the ground clear of the track.

Lining bars should be inspected for cracks especially if they have been subject to accidental blows by materials being inadvertently dropped on them.

In heavy ballast the slewing is made easier if the weight of the track is taken by Golightly track jacks, but the Trewella jacks should not be used for this purpose.

A disadvantage with the use of lining bars is the damage done to the formation, as the hole is enlarged with movement of the bar during aligning, and water is thereby permitted to collect in the formation.

Track aligners are now in use and although slower in action they are very powerful, and as they rest on the ballast in operation, no damage is done by them to the formation. See 15.06.

Lining is much more difficult with track in bad condition if the spikes are loose and the timbers badly rail cut, as a large amount of the effort applied will only cause the rail to lift from the sleepers and fall back into position after the pull has been made.

LINING STRAIGHT TRACK

The centre of any major irregularity in the alignment should first be accurately determined, as this point should first be thrown in adjusting the alignment. Minor adjustments should follow, and for this work sighting should be done closer to the lining gang as oral directions to the men are necessary.

Lining bars must be kept clear of the rail to give an unobstructed view of the rail while the alignment is being sighted.

The final correction of alignment should be done with a few good men moving forward over a short distance and pulling lightly to gradually correct local irregularities.

LINING CURVED TRACK

Under the action of traffic, displacements occur from regular curvature and portions of the curves assume the form of parabolic arcs comprising lengths of relatively flat curvature alternating with short sections of sharp curvature.

Lining of curved track therefore consists of pulling out the flat sections and throwing in the sharp section to restore the condition of regular curvature. The flat portions of the curve should be pulled out first to free the expansion spaces at the joints, and the sharper portions should then be thrown inwards.

To avoid kinks the track must be pulled over gradually, particularly if trains are likely to pass over the track during lining, as a bad kink might cause derailment.

The running edge of the outer rail should always be used as the basis for correcting curvature and not the unworn side of the rail.

Pulling should be confined to the short length of curve requiring alignment, and the curvature should be checked from centre pegs or by means of the string and middle offsets if pegs are missing.

Care should be taken when correcting a curve that the string is not carried beyond the tangent point of the curve, as the offsets of transition curves vary considerably from those of the regular curve. The same condition applies at common tangent points (C.T.P.) of compound curves.

STRING LINING

To locate the position of a missing centre line peg as at 'D' in Fig. 11 : -

1. Measure the middle offsets at intermediate pegs for several intervals on each side of the missing peg and take the average of these measurements. See 3.25.
2. String from peg 'C' to 'E' and set off the average offset at the centre point to establish the position of the missing peg at 'D'.
3. The position so found should be marked by a temporary peg; permanent pegs should not be driven other than by surveyors.
4. Check this position by the offsets at 'C' and 'E'.

To correct the alignment at a local kink in a curve intended to be of regular radius :-

1. Determine approximately the centre of the kink, either by eye or by comparison of adjacent middle offsets taken on overlapping chords.
2. Compare the average of three adjacent middle offsets with the measured offset at the centre of the kink, the difference equals the throw required at the kink.

If the average of the three adjacent middle offsets exceeds the measured offset at the kink, the curve is 'flat' and must be thrown 'out' by the difference.

Conversely, if the average of the three adjacent middle offsets is less than the measured offset at the kink, the curve is 'sharp' and must be thrown 'in' by the difference.

The throw is required only at the kink.

Example, Fig. 12.

Middle offsets at	'B'	=	$1\frac{3}{4}$ "	
" "	'C'	=	$2\frac{1}{2}$ "	(centre of kink).
" "	'D'	=	$1\frac{3}{4}$ "	
	sum	=	6"	Average = $\frac{6}{3}$ " = 2"

Difference = Offset at centre - Average Offset
 = $2\frac{1}{2}$ " - 2" = $\frac{1}{2}$ " 'inward' throw at 'C'
 No throw is required at 'B' or 'D'.

3. Check the new position at 'C' by new offsets at 'B' and 'D', these should be the same after the throw 'in'.

GAUGING TRACK

Whether correction of gauge is necessary or not is more readily seen after the surface and line have been corrected. If adzed sleepers are in use, as on second class tracks, the inclination of the gauge rail seat should be trued up with the adze.

Rail cut sleepers should be dressed off to flange level to facilitate accurate cross boring and enable the spikes to be driven down to contact with the rail flange.

All the old spike holes should be plugged with wooden plugs provided for this purpose, as the ingress of water at open spike holes tends to promote decay of the sleepers.

Adzing may be more readily performed while the track is only lightly filled with ballast sufficient to hold the alignment.

As rail cutting of the sleepers is usually greater under the inner rail, and spiking is duplicated on the outside of the rail flange of the outer rail on sharp curves, it will be appreciated that gauging should rightly be done on the inner rail. Thus the practice of lining the outer rail and gauging the inner rail on curves is in accordance with theory and economy.

Gauging of the outer rail would result in four spike holes along the outside of the rail flange thereby greatly weakening the sleeper and leaving the inner rail on its rail cut seat.

Main tracks are now mostly provided with sleeper plates to reduce the wear on the sleepers and afford lateral support to the rail thus reducing the tendency to spreading of gauge.

SURFACING DETAILS

Before the work of lifting is undertaken the track should be free from weeds of substantial size as their presence will foul the ballast and obstruct the view for lining.

All spikes should be driven down to contact with the rail flange so that the sleepers will come up uniformly with the rail when lifted.

If the ballast is water logged it should be opened out to drain and allow the road bed to thoroughly dry out before lifting is commenced.

The amount of the lift will frequently depend on the ballast in track and the evenness of its distribution. Where no ballasting has been done for a considerable period, some parts will be found more bare than others and if these predominate, they will govern the amount that can be given at the first lift.

Final surfacing will then follow the distribution of topping ballast; but if ballast is not available in quantity for this purpose it may be necessary to resort to patching.

PATCHING

Patching is the distribution of ballast, at intervals and in varying quantities, for the purpose of restoring the ballast profile of the track.

In the distribution of patching ballast care must be taken that no more than sufficient to even up the ballast profile is discharged, as the work entailed in lifting and transporting the excess ballast should be avoided.

STRENGTHENING TRACK

Strengthening track involves increasing the depth of ballast below the sleepers, or increasing the number of sleepers per rail length, but usually both operations are involved. In some cases widening of formation is also necessary, and not infrequently attention to drainage is required.

LIFTING LIMITATIONS

The maximum lift usually given at one time is 3 inches; higher lifts usually involve an amount of work proportional to the lift, a lift of 2 inches causing double the work of a lift of 1 inch.

Higher lifts, subject to the capacity of the track jacks, may be necessary on occasions, but subsequent subsidence will be greater according to the height of the lift, and a light surfacing lift will usually be necessary after settlement under traffic and before final aligning and gauging.

On curves the lift should not ordinarily exceed $\frac{1}{2}$ inch at a time, owing to the risk of derailment and the possibility of end bound sleepers if the outer rail is being raised.

With mechanical packing, a lift of 10 inches has been made on overseas railways and the line opened for fast traffic in a very short space of time.

The settlement of the ballast with mechanical packing may be taken at one quarter of that following beater packing, but usually the first lifts are better packed by the shovel and beater.

In the electrified area lifting is generally confined to light surfacing to take out surface nips. A high standard of packing is necessary under these conditions and metal ballast is therefore in use; the time available between trains is limited and the packing must be done quickly and soundly, otherwise the surface will not hold for any length of time.

Out of face surfacing under conditions of heavy traffic is beyond the capacity of the section gang, and it is usual to allot this work to a special gang of sufficient strength to handle the work between trains. In some cases occupation of the track is necessary, and if this cannot be given the surfacing may require to be carried out at night while the track is free from traffic.

On country branch lines the infrequency and slow speed of traffic may not warrant the maintenance of a first class surface and attention will mostly be paid to surfacing out the nips leaving the longer slacks undisturbed.

From a short term economy viewpoint the neglect of long slacks may be justified under the heading of deferred maintenance, but additional expenditure in haulage costs will accrue as the surface continues to deteriorate.

BOXING UP

Boxing up the track with ballast and trimming to the track profile is of necessity deferred until the packing and finallining of the track is completed. But as the function of the boxing and shoulder ballast is to hold the track in line, control the creep and contribute to the stability of the track, this operation should not be unduly deferred. Boxing up of welded track must always be done after lifting and lining.

In the electric traction area and on electric signalled sections of the track, the boxing ballast must not contact the rails because of the leakage to earth of the electric current which would occur, and for this reason a clear space of $1\frac{1}{2}$ inches must be maintained between the rails and the ballast.

SLEEPER DAMAGE

As the qualities of sleepers vary considerably, so also does the useful life vary in service, and this is further influenced by the degree of maintenance of the track.

Conditions are most severe under the rail joints and on curves; if the joints are not well maintained the joint sleepers are subjected to vertical battering which destroys the fibre of the timber under the rail, and in addition the sleepers are subjected to a rocking motion tending to cause them to burrow into the ballast.

On light track laid with short rail the anchorage against creep is concentrated at the joint sleepers by the rail pins thereby tending to move the joint sleepers slightly off their ballast beds.

Longitudinal movement of joint sleepers, in relation to the direction of the track, tends to crowd the leading intermediate sleeper in the direction of creep and to increase the space between the joint sleeper and the following intermediate sleeper. The increase in sleeper spacing concentrates the loading over the following intermediate sleeper thereby damaging the rail seat and heavily stressing the rail.

With angle fishplates the pressure on the dogspikes is longitudinal and lateral in respect to the direction of the track, and the timber fibre is crushed by the spike pressure thus loosening the spike.

On curves the lateral pressure of the train tends to force the spikes over and destroy the grip on the sleepers at the outer rail, while the greater weight of slow goods trains is concentrated on the inner rail tending to crush the timber under the rail seat and reverse the rail inclination.

Although creep usually takes place in the direction of heaviest traffic and down grades and therefore is generally in the up direction or towards Melbourne, cases do however arise where the rails creep away from Melbourne and sometimes in opposite directions.

When the creep is in opposite directions the tendency is to skew the sleepers across the gauge and thereby reduce the gauge; this tendency is resisted by the method of spiking shown in Fig. 13, and the ledges on sleeper plates used in main tracks.

The usual cause of a sleeper breaking under the rail seat is excessive packing of the sleeper out-end, thus concentrating the loading on the unsupported portion of the sleeper. This condition will arise when the outer rail is lifted to correct the cant on curves and the packing is neglected within the gauge.

A broken sleeper is usually indicated by the out-end rising out of the ballast profile, but the indications that fracture has occurred may be noted by a dark discoloration of the sleeper at the rail seat. Sleepers suspected of fracture may be tested with a bar by lifting the out-end.

Another cause of sleeper breakage is the weakening of the sleeper by repeated cross boring and re-adzing. Sleepers should be inspected for soundness whenever the ballast is opened out for surfacing and doubtful sleepers should then be marked for subsequent attention.

Irregular adzing of sleepers at the rail seat results in uneven support of the rails, thereby setting up torsional stresses in the rails and sleepers. Torsional stresses in rails cause the rails to wriggle under traffic, and increase the rate of wear between the rails, sleepers and fastenings.

SLEEPER RENEWALS

The necessity for sleeper renewals calls for sound judgment on the part of trackmen, and considerations of speed, grades, curves and the general condition of track should govern what re-sleeping is undertaken.

Sleeper renewals involve disturbance of the road-bed and re-distribution of the loading among adjacent sleepers and for this reason renewals should be deferred as long as possible consistent with safety.

The urgency for renewals is greatest where several adjacent sleepers are in bad condition, but here again it may be inadvisable to renew all the defective sleepers. If sleepers are sound but spike killed it may be sufficient to renew each third sleeper for gauging reasons.

On sharp curves and on curves carrying high speed traffic, particular attention must be given to adequate sleeper renewals. Sleepers released from high speed curves or at the foot of steep grades may be suitable for use at the top of a grade or in a siding.

Joint sleepers, being subjected to severe service conditions, will generally require earlier renewals, but the released joint sleeper may be serviceable to interchange with a sound intermediate sleeper.

If a track is being surfaced out of face it is desirable that the sleeper renewals be made simultaneously, as the track will then settle evenly.

Depending on the conditions of ballast and the differences in sleepers, the renewal of isolated sleepers calls for some skill on the part of trackmen.

In certain gravel ballasts it is possible to start the spikes in adjacent sleepers and lift the rail slightly to enable the old sleeper to be withdrawn endwise. The new sleeper will usually require a skimming off the ballast bed to allow it to go into position, and with care this may be done thereby avoiding disturbance of the road bed.

When the ballast is free it is usually better to trench out on one side and remove the sleeper sideways into the trench and likewise install the new sleeper.

With metal ballast the difficulty of removing the sleeper is greater owing to particles of metal having bedded into the sleeper, and skimming off the sleeper seat is likewise more difficult; it is therefore preferable to break up the surface of the ballast bed and beater pack the new sleeper.

The difficulty in renewing sleepers in station pits, cuttings, level crossings and similar locations warrants the special selection of first class sleepers for these situations.

In narrow cuttings renewals may be facilitated by slewing adjacent sleepers to allow the defective sleeper to be removed without disturbing the formation.

Spiking to a suspended sleeper can result in the force of the hammer blow coming on the rail flange with the possibility of damage to the rail.

A device in use on overseas railways enables the sleeper to be held to the rail during packing, as shown in Fig. 14, and some of these devices have been obtained for trial.

If the sleeper is uneven or in wind, the saw cut for adzing may be deeper on one side than on the other, in which case the surface should be adzed off to an even depth otherwise the dogspikes cannot be driven down to the rail flange.

When the track is being strengthened by the addition of sleepers, the re-spacing results in sleepers being spotted off or partly off the old sleeper beds; the beds should therefore be thoroughly broken up to allow of even settlement. Neglect in this respect can result in very uneven surface and considerable difficulty in the subsequent maintenance of the track.

Practical experience alone can teach the trackman the many practical considerations which enter into the manner and order of sleeper renewals, and it behoves trackmen to be on the lookout for better methods of doing this work.

SPIKING

The fastening commonly in use to secure flat bottom rails to the sleepers is the driven dogspike.

Double headed and bull head rails are supported by cast iron or pressed steel chairs and secured by pins and timber or spring steel keys.

Fang bolts and screw spikes are also used with both types of rails on overseas railway tracks, but few of these fastenings are now in use in Victoria.

Elastic spikes of a goose neck pattern made from spring steel are on trial. See 10.03.

The standard dogspike is driven at 90° to the rail base as shown in Fig. 15. Driving is done with the spiking hammer by hand or by the pneumatic hammers when a large number of spikes are to be driven and pneumatic equipment can be used to advantage.

In driving the dogspike by hammer the trackman should stand outside the gauge facing along the track. The dogspike should be inserted in the hole square with the rail so that when driven to position a full bearing on the shank will be made with the edge of the rail flange.

It is a mistake to correct the position of the dogspike when partly driven, by bending or attempting to draw the spike to the rail flange as the nose of the spike then contacts the rail flange and the head may be broken off. A bent or drawn spike has no support from the sleeper at the back of the spike, and its holding power is greatly reduced in consequence.

The standard dogspike should be driven down to contact with the rail flange, but the last few blows of the hammer should be light blows to avoid damage to the rail flange.

Badly pointed dogspikes tend to rotate and lead away from the driving alignment and their use is uneconomical. Such spikes are occasionally met with, owing to rejects being inadvertently loaded; they should be returned for re-pointing rather than be used to the detriment of the work.

Elastic spikes are driven with a short shaft 7lb. hammer and a gauge to ensure the correct tension in the spike, the boring is done with a $\frac{5}{8}$ " auger at right angles to the base of the rail flange, but the position depends on whether adzing or sleeper plates are in use.

The driving positions for the two types of elastic spikes on trial are shown in Figs. 16 & 17.

Another type of elastic spike in use in England is shown in Fig. 18; this spike is not at present available in Australia.

JOINT MAINTENANCE

Given that the sleepers, the packing and drainage are in good condition and the joints therefore properly supported, then the chief maintenance of the joints will involve periodical attention to the tightening of the fishbolts.

As the joint derives its strength from the tension of the fishbolts, it is of prime importance that the correct tension shall be maintained. The nut fitting is designed to be spanner tight after the first $1\frac{1}{2}$ turns of the thread have been engaged, and the desirable bolt tension is attained when the spring washers have been closed flat under the nut.

No good purpose is served by tightening the fishbolts beyond the strength of the washer, and the use of pipe extensions on the standard spanners is not permitted.

While every reasonable care is taken in the production and inspection of fishbolts, ill-fitting nuts will be found, and if time permits a better job may often be done by interchanging the nuts. This procedure, if followed too far, would be wasteful of valuable time, but where a joint is troublesome a few minutes spent on selection of the bolts may result in considerable time saving in repeated attention to the joint.

The support afforded to the rail ends depends upon the accurate fitting of the fishplate in the fishing angles of the rails; it is therefore of importance that the fitting faces shall be clean and the fishplates be assembled in full face fitting.

To ensure correct fitting the fishplates should be driven in at the bottom during the tightening of the fishbolts. Tightening should first be done on the two bolts in the centre of the fishplate and the end bolts be tightened last. All bolts should be tightened to the same tension because if one bolt is too tight other bolts will be loose.

Irregular bolt tension in different joints tends to promote creep; the relative tightness of the bolts may be tested by sounding the bolts with a light hammer or by applying the fingers to the nut end while lightly striking the head of the fishbolt.

After it has been tightened the joint will be slightly raised, but will settle again under traffic.

If the nuts are backed off $\frac{1}{4}$ turn before tightening and the spanner be applied to pull upwards, accidents will be rare, should the bolt twist off at the nut. In pulling upwards the trackman should have both feet on the same side of the rail, as the danger of rupture is thereby reduced.

The angle of the nut when tightened is of no importance, tightness is the requirement and not neatness in this job.

If the fishplates are much worn, tightening of the fishbolts may draw the rail end downwards and spoil the joint; also if the wear is such that the fishplates are in contact with the webs of the rails, no advantage is to be gained by repeated tightening of the fishbolts.

Wear in the fishing angle of the rails can only be compensated for by the use of special cambered fishplates, shims are only a temporary improvement. Cambered fishplates should not be applied to new rail with the idea of preventing sagging at the joint, as this condition would in fact be aggravated thereby.

Again, over-packing the joint sleepers will seldom correct a hogged joint, and extra hard packing under the receiving end causes flattening of the rail head in this position.

Over-tightening may so lock or freeze the joint as to seriously interfere with the free expansion of the rails.

Freedom of expansion in joints is facilitated by lubricating the joints, for which purpose dry lubricants like graphite are more enduring than viscous lubricants like oil. Specially prepared, water mixed, graphite paste is provided for this purpose and is much in use on overseas railways.

To prevent the ingress of water and wind blown abrasives it is usual to seal the space at the ends of the fishplates with a plaster material, but this procedure is at present only at the trial stage in Victoria.

The replacement of broken fishbolts is a matter of importance, and should the fishbolts continue to break in any joint, the cause should be sought and the trouble be rectified rather than continue renewal of the fishbolts. Apart from occasional defects in material and manufacture, the usual cause of bolt breakage is due to incorrect boring of the rails either in the size or position of the fishbolt holes.

When the holes are so placed that contact exists between the rail web and the bolt shanks, considerable impact occurs on the bolts and breakage is to be expected, also, if this condition for long obtains, the rail will develop shatter cracks in the web and ultimately break.

As standard fishplates are in some instances interchangeable with older materials, it is of importance that the boring in the old rails be corrected before fitting the new standard fishplates.

An instance of this arises when 80 lb. A.S. rails of the two standards are fished together; the holes in the earlier 80 lb. A.S. rail are $1\frac{1}{8}$ " diameter for $\frac{7}{8}$ " diameter fishbolts while in the later 80 lb. A.S. rails the holes are $1\frac{1}{4}$ " diameter for 1" fishbolts.

When the 1" diameter fishbolts are used in such locations the expansion is reduced by $\frac{1}{8}$ ", and if insulated joints are installed under these conditions, insufficient room is available for the free insertion of the fishbolts and insulating ferrules.

The remedy for this condition is to re-bore the older class rail to the larger bolt hole size, an operation which requires some skill as the drill will tend to over-feed and bind in the hole.

A specially sharpened drill or a reamer should be used for opening out small holes, and if this is not available a round file should be used instead.

An extension of joint life may be obtained by interchanging the inner and outer fishplates where this is practicable, and with 6 hole fishplates, by moving the fishplate one bolt hole space, since only 4 bolts are now used. In moving the fishplates the direction of movement should generally be against the traffic, as better support will thus be afforded to the receiving rail.

RAIL MAINTENANCE

Maintenance of rail is mainly associated with removal or reduction of the effects contributing to the destruction of rails.

Rail wear and destruction is at a minimum when the conditions of surface, alignment and gauge are well maintained, and these in turn are dependent upon joint conditions, sleepers, packing and drainage.

Regularity of curvature and of cant, with the provision of track lubrication where justified, greatly increase the life of the outer rails on curves.

Uniform adzing of sleepers and adequate maintenance of track fastenings further contribute to long rail life.

The deposition of metal to build up worn portions of rail, usually at joints, is an aid to prolongation of rail life, but the process has limitations owing to the disadvantageous conditions under which it must be carried out. If practicable, better results may be had by spinning or changing a rail to improve joint conditions, rather than resort to building up by welding.

Owing to the different conditions of wear obtaining on rails in the inner and outer positions on curves, it is not generally practicable to transpose isolated rails from one side to the other, but groups of rails may be transposed in favorable circumstances, and in most cases to the straights.

Transposition of rails was much practiced in the past, but with the higher standard of track laid today it is probable that re-gauging will seldom be necessary during the main track life of the rails, and when the rails are worn to the permissible limit for main tracks, it will be more economical to re-lay and re-use the old rails in sidings.

When defects are associated with joint conditions, it is frequently possible to crop the defective rail ends and use the rails as closures.

LINING OUT A BUCKLE

Buckling of track is caused by the expansion of the rails and the inability of the ballast to resist the lateral stresses set up by the expanding rails.

In well aligned straight track, buckling may commence at a loose joint if the ends of the rails are not truly square cut, or the lateral pressure of wheel flanges under oscillation of vehicles may distort the alignment sufficiently to commence a buckle after the passage of a train.

Under the weight of a train, buckling cannot commence during the passage of the train.

Insufficient ballast or inferior ballast may allow of enough movement to commence a buckle.

On curves the tendency to buckle is increased owing to the initial curvature of the rails. If the buckle should occur on the inside track of a double track curve, the clearance may be fouled and trains cannot be permitted to pass each other in the buckled section.

To restore the alignment all joints must be freed to take advantage of the available expansion spaces. If creep is a contributing factor the rails must be pulled back, time permitting, or a short length be cut out to compensate for the amount of creep.

Cutting should be avoided if possible, as the buckle will usually occur late in the day and within a few hours the contraction of the rails will permit of re-alignment.

When the track has buckled in an 'S' curve, the buckle will tend to run in the second loop while attempts are being made to line out the first loop. In some cases it is preferable to throw the track out to one curvature and then throw the whole curve inwards.

With double track it may be possible to jack the inner track away from the outer track and 'tom' the sleepers to maintain the clearance pending adjustment for creep and expansion spaces.

HALLADE TRACK RECORDER

As the maintenance of track must be governed to a large extent by reasons of economy, it is necessary that attention be first paid to the more pronounced defects affecting the safety and smooth running of trains.

The accurate determination of isolated defects in the riding condition of a mileage of track has in past years been a matter of judgement on the part of the track maintenance staff, but it is now possible by means of the Hallade Track Recorder to chart the position and nature of these defects. If the isolated defects are corrected, the general condition of the track is improved and damage to the track reduced to a minimum.

The Hallade machine operates on the principle of the pendulum or swinging weight commonly used in the pendulum clock.

In starting a pendulum clock the pendulum may be swung to commence its movement or the clock may be tilted, either operation having the desired effect.

If the clock is tilted it will be observed that the pendulum remains in its original position relative to a point on the mantelshelf.

This is what happens in the Hallade machine; the machine body moves with the movement of the vehicle and the pendulum remains behind, and being connected to a recording mechanism it registers the amount of movement of the machine and therefore of the vehicle.

For those who have to deal with the interpretation of Hallade Charts, a departmental booklet has been issued, but as all trackmen will be interested in correcting defects disclosed by this instrument, a portion of the departmental booklet is reproduced as follows : -

THE INSTRUMENT

The Hallade Recorder consists of two parts : -

- (1) The clockwork motor which drives, by means of a chain, a drum carrying the paper on which the record is made. The rate of movement is controlled by a governor adjusted to unroll the paper at the rate of five inches per minute. See Fig. 19.
- (2) Three sets or series of pendulums connected to needles which record the movement of the pendulums. Each of these pendulums is mounted so that it will respond to particular movements only. See Fig. 20.

PENDULUMS

- (a) The first set is sensitive to 'rolling' of the car from side to side about an axis along the length of the car, and also to pulling and buffing from the engine.
- (b) The second set is sensitive to side thrust or side slog which causes the car to 'lurch' to either side.
- (c) The third set is sensitive to vertical movement or 'bouncing' of the car.

The Instrument may be used in any vehicle but for track testing purposes it is generally used in the same passenger car so that, as far as practicable, vehicle conditions are eliminated. It is placed in the car as close as possible to one bogie so that the chart shows the effect from one bogie and not a combined effect from the two ends.

With low speeds relatively little can be derived from the charts. At high speeds the track defects are shown in a more pronounced way, as they produce heavy and sudden shocks on the car. In order that the full influence of high speeds may be noted and to minimise big variations in speed such as occur with stopping trains, the train selected for the test is generally the fastest over the section tested.

THE CHART

To illustrate the following explanations, samples of the charts obtained from test trips on the Victorian Railways are given in diagrams 1, 2, 3, 4, 5A, 5B, 6A, 6B, 7, 8, 9, 10 and 11. (These diagrams are approximately two-thirds the size of the actual charts).

On these diagrams, letters are used to indicate various oscillations and it will be noticed that each letter appears several times. The reason for this is that each particular letter is used for the one type of oscillation as described in the following pages. Charts issued after a test will be marked according to the same system of lettering to indicate the various faults in the track.

SUMMARY OF LETTERS

The following table gives a list of the letters used in the diagrams, a brief description of what they indicate, and the page on which a fuller explanation is to be found : -

Letter	Brief description of indication	Page
<u>LINE 2.</u>		
A	Centre bound track.	11.28
B combined with O (Line 3)	Succession of kinks.	11.29
C combined with P (Line 3) and V (Line 4)	Severe hole in one leg of the road with track out of line.	11.29
W	Application of brakes.	11.29
X	Stoppage of train.	11.29
Y	Acceleration of train.	11.29
Z	Draw bar pulling or buffing of the engine.	11.30
<u>LINE 3</u>		
D	Sharp kink in curve.	11.32
E	Flat length in curve.	11.32
F	Cant is greater than on other parts of curve or the curve is flatter.	11.34

Letter	Brief description of indication	Page
G	Cant is less than on other parts of curve or the curve is Sharper.	11.35
H	Transition curve at end of the main curve.	11.36
J	Cant ramp on the straight approaching a curve.	11.37
K	Side thrust starting to act at the tangent point of a curve.	11.37
L	Side thrust when travelling along diverging road at points.	11.37
M	Cant on straight track.	11.38
N	Kink in straight track.	11.38
O combined with B (Line 2)	Succession of kinks.	11.38
P combined with C (Line 2) and V (Line 4).	Severe hole in one leg of the road, with track out of line.	11.39

LINE 4

Q	Rail or sleeper swinging.	11.39
R	High packing of sleeper.	11.40
S	Badly packed length.	11.40
T	Sag in track.	11.41
U	Hump in track or hog backed rail.	11.41
V combined with C (Line 2) and P (Line 3).	Severe hole in one leg of the road, with track out of line.	11.41

LOCATION LINE

Line 1 is a straight line marked to indicate mile and half-mile posts, stations and other features which enable locations to be fixed.

The system adopted is : -

Mile posts	..	2 marks
Half-mile posts	..	1 mark
Stations	..	3 marks
Other features	..	Series of marks.

The mileage of the posts, the names of stations, and other features will be found written at the bottom of the diagram slightly to the right of the marks to which they refer.

Line 1 is used for two purposes : -

- (a) As the speed of the motor has been adjusted to unroll the paper at five inches per minute, the time taken for the train to travel over a mile or half-mile can be ascertained by measuring the length of paper between adjacent markings. It is therefore possible to calculate the average speed of the train : -

$$\begin{array}{l} \text{Average speed} \\ \text{over half-mile} \end{array} = \frac{60 \quad \times \quad 2.5}{\text{length of paper in inches between adjacent mile and half-mile posts}}$$

$$\begin{array}{l} \text{Average speed} \\ \text{over one mile} \end{array} = \frac{60 \quad \times \quad 5}{\text{length of paper in inches between mile posts or between half-mile posts}}$$

- (b) From the adjacent posts, the location of any point can be determined with accuracy. For example, in diagram 1, there are high oscillations recorded in line 2 at 23M.55C., in line 3 at 24M.19C., and in line 4 at 23M.77C.

The chainage in each case is picked up by proportion between the adjacent posts marked on the chart. It is thus possible to locate, with a high degree of accuracy, that part of the track which is causing rough riding.

CURVE LINE

Line 1a, which, when necessary, will be drawn on the chart in the drawing office, will show the location and direction of curves in the track. It is useful when special study is to be given to the riding of vehicles on curves. This line is shown in diagrams 3, 4, 5A, 5B, 6A, 6B, 7 and 9.

ROLLING LINE

Line 2 is drawn by the pendulum which is sensitive to the rolling of the car. Excessive rolling recorded in line 2 in diagram 1, is indicated by the letters A, B and C.

The explanations of these are given hereunder : -

- A - indicates that the car is rolling from side to side due to such conditions as : -

Centre bound track.
Hard packed centres.
Cross nips.

- B - indicates rolling of the car at the same time as side lurching indicated by 'O' in line 3. The combination of rolling and side lurching points to a succession of kinks in the track.

Each kink causes a side lurch as the car is forced into a new direction and the lurching from one side to the other at each successive kink will set up rolling of the car.

- C - indicates rolling of the car at the same time as side lurching (marked P in line 3) and vertical movement marked V in line 4) occur.

The cause of this combined movement is a severe hole in one leg of the road with the track out of line. The dropping of the car is recorded as vertical movement and the slipping down on one leg is recorded as a half-lurch. In consequence the car started to roll; this is recorded in line 2.

Rolling in a car is generally the result of poor or faulty maintenance. Where charts give such indications, the track force should effect repairs as soon as possible, and the ballast beneath the centre of the sleeper should be 'guttled' out to bring the support beneath the rails. If rolling be caused by poor alignment, the track must be pulled to line.

It will be noticed that in diagram 2, there are several other letters marked on line 2. These letters are used to mark places where line 2 deviates from the straight line, owing to operating conditions.

The following gives the explanation of these letters :-

- W - a general drop in the level of line 2 as noted several times between the 52 M. post and the station is due to the application of brakes and the consequent reduction of the speed of the train.

When the brakes are released the level of line 2 rises to its normal position.

- X - near the station, is the recovery of the needle to its position of rest when the train stopped.

- Y - a general rise in the level of line 2 as seen in diagram 2 beyond the station is caused by the acceleration of the train as it is gathering speed.

Z - is caused by a sudden draw-bar pull from the engine. In very short trains or trains on which the vehicles are not tightly coupled, draw-bar pulling and buffing of the engine are often noticed and are shown in line 2 by the same type of record as given by rolling of the car.

To avoid confusion in reading the charts this draw-bar pulling will be marked on the charts by this letter.

It should be noted that indications W, X, Y and Z are all due to train operation and have no relation to track conditions.

LURCHING LINE

Line 3 can be called the 'lurching' line as it records the side lurching or slogging or the side thrust of the car due to : -

- Irregular line.
- Irregular cross level.

If the track be in proper order, the chart will show a series of small oscillations about a straight line called the datum line.

To understand the record given in line 3, it is necessary to consider what happens when a car is forced by the track to change its direction.

When a train travels around a curve, it exerts a thrust outward on the rails and track. The magnitude of this thrust depends on the speed and sharpness of the curve; the higher the speed and the sharper the curve, the greater will be this outward thrust. This outward thrust of the train is an overturning force tending to throw the greater proportion of the weight of the train on to the outer rail and relieve the inner rail of portion of its share of the load.

To balance, to some extent, the portions of the load carried by each rail, the track is canted inward so that some of the weight is thrown back on to the inner rail of the curve. If all trains travelled over a given curve at the same speed, it would be possible to give the curve the cant which would exactly divide the weight of the train between the two rails. But due to varying conditions, the speeds at which trains negotiate curves differ considerably. It is not therefore possible to provide a cant which will give an exact division of the load between the two rails for all speeds.

Our practice is to cant the track for a speed intermediate between the maximum and minimum speeds at which trains negotiate the curve. This intermediate speed for which the track is canted may be called the 'cant speed'. If the train traverses the curve at a speed which is different from the 'cant speed', there is a throw of the train towards the outer rail if the actual speed is greater than the 'cant speed', and towards the inner rail if the actual speed is less than the 'cant speed'. This of course is unavoidable.

The needle drawing line 3 indicates when one rail is carrying more of the weight of the train than the other. Each time the distribution of the weight of the train between the two rails is varied it is recorded by a movement of the needle.

If the diagram be held so that it lies in the direction in which the run is made, the upper side of the datum line represents the left-hand rail, and the lower side the right-hand rail.

If the needle moves above the datum line it indicates that the left-hand rail is taking a greater share of the load than the right-hand rail and the thrust is towards the left.

If the needle moves below the datum line it indicates that the right-hand rail is taking a greater share of the load than the left-hand rail and the thrust is towards the right.

Take the curve from 62 M. 23 C. to 62 M. 38 C. in diagram 3, and study the oscillations recorded in line 3. It will be seen that the needle has moved rapidly from side to side, indicating that the greater part of the weight is being thrown from one side to the other.

At the places marked 'D' the outer rail carried the greater share of the weight with the side thrust towards that rail. At the places marked 'E' the weight has been thrown back to the inner rail with the side thrust towards that rail.

The change in the direction of the side thrust and in the distribution of the weight of the train between the two rails can be caused by three factors : -

- (1) Appreciable alteration in speed of the train. Notice however that in diagram 3, there is no drop or rise in the general level of line 2, indicating that there is no appreciable alteration in the speed. Moreover, it would be impossible for the speed to change to such an extent to cause such a 'throw' as shown at 62 M. 36 C.

- (ii) Appreciable alteration in cant. Any alteration in cant would take place slowly and would certainly not cause a swing of the magnitude of those marked 'D' and 'E' at 62 M. 36 C.
- (iii) Variation in the radius of the curve. A variation in radius of the curve will cause a swing of the needle because the weight will be thrown more to the outer rail if the curvature becomes sharper and less if the curvature becomes flatter.

In the curve at 62 M. 23 C. - 62 M. 38 C., the rapid oscillations have been caused by variations in radius, these variations being sharp kinks and flat lengths in rapid succession.

Notice in diagram 3 and 6A, that in all the curves the needle has swung violently from side to side - this is caused by the sharp kinks alternating with the flat lengths. While these sharp kinks balance out with the flat lengths to make the average curvature correct, they cause rough riding and discomfort to passengers.

The letters 'D' and 'E' have therefore the following meaning : -

- D - the curve has a sharp kink (sharper radius than adjacent portion of curve).
- E - the curve has a flat length (flatter radius than adjacent portion of curve).

These sudden variations in radius are caused by conditions such as : -

Straight rails in curve.
 Over-curved rails in curve.
 Crippled rails.
 Worn rails.
 Kink at joints.
 Variations in gauge.

Where such violent oscillations are recorded by the needle, the track force must line in and pull the track and effect the necessary repairs.

In diagram 4, the effect of different speeds on the same curve is shown. At a speed of 51 miles per hour the needle in line 3 has oscillated very close to the datum line. This shows that the actual speed was very close to the 'cant speed'.

At higher speeds of 57 and 66 miles per hour the needle has swung out and oscillated at some distance below the datum line, showing that the outer rail of the curve was carrying more than half the load. (The same condition may be noted in diagram 5B, along the curve from 62 M. 23 C., to 62 M. 38 C.

The line along the centre of these oscillations is called the 'mean line'. The fact that the needle has oscillated about a 'mean line' off the datum line shows that one rail is carrying more load than the other, but provided the oscillations are small, does not imply that the riding is rough.

In the chart taken over the curve at 51 miles per hour (the upper part of diagram 4), a side lurch (D) was recorded at 38 M. 34 C., due to a kink at a joint. When tested at 57 miles per hour (middle part of diagram 4), the side lurching was more pronounced and on the third test at 66 miles per hour (lower part of diagram 4), the side lurching was very violent. It will be seen from this that with high speeds true line is essential for good riding.

It will be noticed that the adjacent flat length 'E' in the curve, while throwing the greater share of the load on to the inner rail at a speed of 51 miles per hour, only threw part of the load back to the inner rail with the higher speeds of 57 miles per hour and 66 miles per hour.

Diagrams 5A and 5B, 6A and 6B show the charts taken on two different trips at the same speed in each case : -

- 5A & 6A - the record taken on the first trip;
- 5B & 6B - the record taken after attention had been given to curves.

Note the considerable reduction in the amount of oscillation recorded on the second trip. Prior to the second trip the following work had been done on the curves : -

- (i) Curve 62 M. 23 C. - 62 M. 38 C. (diagrams 5A and 5B) was re-pegged and pulled, and transition curves were fitted to connect the body of the curve with the straights at each end.

The object of transition curves is to ease the curve at its ends so that trains are turned gradually into the curve. The transition curve gradually sharpens in radius after it leaves the straight until it reaches the radius of the central part of the curve. Along this transition curve the super-elevation of the outer rail increases from zero at the tangent point to the specified value for the curve.

If the train had passed over the curve at the 'cant speed', the needle would have made small oscillations about the datum line. Actually the train traversed the curve at a higher speed, thus throwing the greater part of the load on to the outer rail - indicated by the needle moving to the right-hand side of the datum line and oscillating about a mean line.

The gradual turning of the car along the transition at the ends of the curve at 62 M. 23 C. and 62 M. 38 C., from the straight to the body of the curve is shown by the gradual movement (H in diagram 5B) of the needle from oscillating about the datum line to oscillate about the mean line.

- (ii) Curves at 62 M. 44 C - 62 M. 50 C. (diagrams 5A and 5B), 62 M. 77 C. - 63 M. 15 C. and 63 M. 34 C. - 63 M. 53 C. (diagrams 6A and 6B) were lined in and pulled by the track gang without re-pegging.

The comparison of the earlier and later records shows that, by lining in, it is possible for track gangs to remove big peaks in line 3. A flat length, however, was left at 62 M. 45 C. (marked 'E' in diagram 5B), the load being thrown at this mileage on to the inner rail of the curve.

The further letters used in line 3 are explained hereunder : -

- F - It will be noticed in diagram 6B that in the curve 63 M. 34 C. - 63 M. 53 C., the needle moves off the datum line at the start of the curve and oscillates about a 'mean line' and then at 63 M. 38 C. in the body of the curve the needle moves back to another mean line and remains there for a distance of $1\frac{1}{2}$ chains. After this it moves out again to oscillate about a 'mean line' agreeing with the start of the curve.

The factors which may cause this re-distribution of the weight of the car on the rails are : -

(i) Appreciable change in speed. We may disregard this as one of the possible causes in this instance as there is no general drop or rise in the level of line 2.

(ii) Appreciable alteration in cant. The distance between the mean lines of the oscillations is approximately $\frac{5}{32}$ of an inch which would correspond to a change in cant of $1\frac{3}{4}$ inches. The diagram shows that some of the weight has been thrown back at 'F' from the outer rail towards the inner rail, implying an increase of cant.

(iii) Variation in curvature. A variation in radius of curvature causing such a movement as at 'F' is not a sudden and alternating one as at points 'D' and 'E', but the radius of the curve has changed to a new value which is maintained over a distance of $1\frac{1}{2}$ chains.

As the throw to the outer rail is less it shows that the curve has become flatter (larger radius) over this length.

It is impossible to say from the chart which of these two factors (alteration in cant or variation in curvature) has been the cause of the swing, but an inspection of the track will determine it.

G - In diagram 6A, a movement of the opposite direction from 'F' has taken place near the Up end of the curve at 63 M.

At 'G' the needle has swung towards the outer rail of the curve and remained there for some distance.

This movement may be caused by one of the following factors : -

(i) Appreciable alteration in speed. Reference to line 2 shows that there is no general drop or rise in level; hence we deduce that there is no appreciable alteration in speed.

(ii) Alteration in cant. The movement of the needle further to the outer rail of the curve shows that more weight is being taken by the outer rail. This would be caused by a decrease in cant.

(iii) Variation in curvature. This variation is similar to that mentioned under 'F', except that while the radius has changed to a new value for some distance, it has sharpened to a smaller radius for this distance.

Here again it is impossible without examining the track to say whether the cant has altered or the radius of the curve has varied.

Where movements such as 'F' and 'G' have been recorded it is necessary to check both line and super-elevation. At places such as turnouts and crossovers on curves, it is impossible to give the full cant through the points and crossing work. A movement as 'G' would therefore be unavoidable at such places.

It is necessary at some locations to join together curves of different radii in order to provide the necessary clearance at certain points, and movements of the needle such as 'F' and 'G' would then be recorded. Where such layouts exist it is beyond the province of the ganger to eliminate the cause of these movements, but where oscillations as 'F' and 'G' occur in the open track, the track force must take steps to effect improvements.

If inspection shows that the cant needs attention the curve must be adjusted to the cant stencilled on the rails or the centre pegs. If not so marked, the curve must be adjusted to the cant specified in Instruction No. 593 of the Way and Works Book of Instructions.

Curve improvements not only improve riding comfort for passengers but trackmen will find that a curve brought to a good line will be more easily maintained than a bad curve, and in addition uneven wear of the rails will be avoided.

H - the movement of the needle from oscillating about the datum line to oscillate about a mean line and the return to the datum at the ends of the curve at 62 M. 23 C. and 62 M. 38 C. (diagram 5B) are both gradual.

This slow movement (to which reference has been made on page 11.33, in connection with curve improvements), is due to the gradual sharpening of the radius and the gradual increase of cant along the transition. This should always be noted in the case of a transition curve; and where a transition has been fitted and the riding at the entrance of the curve is rough, it indicates that the transition curve needs attention.

- J - In diagram 7, at mileage 82 M. 48 C., the needle in line 3 has left the datum line and continued a slow movement away from the datum line for a distance of $2\frac{1}{4}$ chains. The track here is straight leading to the end of a curve which has not been fitted with transitions to ease the entrance, and the super-elevation required on the curve has been built up on the straight at the end of the curve.

As the car approached the curve along this 'cant ramp' it has been slowly tilted from the vertical to a canted position. The needle has consequently moved below the datum line ('J'), showing that more than half the load is being carried on the right-hand rail which becomes the inner rail of the curve. A similar condition will be noted at 22 M. 6 C., (diagram 9, page 11.58).

- K - When the car reaches the tangent point of the curve just beyond mileage 82 M. 50 C., the force required to move the car around the curve suddenly acts on the car and throws more of the weight to the outside rail of the curve.

This is shown by the sudden swing of the needle from the inner rail (here the right-hand rail) to the outer rail (here the left-hand rail). A similar condition will be noted at 22 M. 4 C. (diagram 9, page 11.58).

- L - In diagram 8, big swings will be noticed at both sides of the station. This platform is on a loop on the right-hand side of the through road, and the turnout at each end from the straight through road is actually a small sharp reverse curve.

In each part of this reverse curve, the greater part of the weight is thrown on to the outer rail. It is impossible to put super-elevation on, or to fit transitions to, such a layout and in consequence the needle swings over to the outer rail in each part of the reverse.

On straight tracks, line 3 will record the side lurching of the car in a similar manner to that on curves.

A car travelling on a straight in good order will ride very smoothly and the oscillations recorded will be very small ones about the datum line as in the length from 22 M. 48 C. to 22 M. 58 C., in diagram 9, but where the track is out of repair the needle will move off the datum line and indicate the following faults : -

M - in diagram 9 at mileage 22 M. 12 C., and 22 M. 30 C., indicates that the car has tilted over to one side slowly and remained tilted for some time before returning to the vertical position.

This has been caused by a cant on the straight track, a condition which results in the track kicking out of line. As the needle moves below the datum line it indicates that the greater share of the load is being carried on the right-hand rail. The load has been thrown on to the right-hand rail because it is the low rail.

N - At mileage 22 M. 62 C., in diagram 9, the needle swings suddenly to one side of the datum, implying that the greater part of the weight is suddenly transferred to one rail instead of being uniformly divided between the two rails. Poor line of the track is responsible for this swing, a kink in the track causing the car to lurch as its direction of travel is altered.

O - The locations marked 'O' in the diagrams are on the straight and are places where side lurching persists over some distance and at the same time as rolling ('B') in line 2. Poor line is the cause of this bad riding.

The difference between places marked 'N' and 'O' is : -

At 'N' there is only one swing of the needle which shows there is one error in line.

At 'O' the continuous swinging of the needle in line 3 shows that the poor line exists over some distance, and the throwing of the greater part of the weight successively from side to side has set up rolling of the car (marked 'B' in line 2).

Where oscillations such as 'N' and 'O' are recorded the cause will be found to be one of the following : -

Elbows in track.
Variations in gauge.
Foul joints.

P - At each of the mileages 25 M. 21 C., and 25 M. 78 C. in diagram 10, a half-lurch has been recorded at the same time as rolling ('C' in line 2) and vertical movement ('V' in line 4).

The half-lurch to the right-hand side of the datum shows that this side rail is taking more than its share of load.

This combination of oscillation is due to a severe hole in the right-hand rail (thus throwing the greater portion of the load on to this side). Such a hole will always cause the track to kick out of line and so give further bad riding. So severe was the drop of the car that it set up rolling and vertical oscillation of the car.

Where any of the above conditions are found in the track, steps must be taken to rectify the fault as soon as possible.

From the foregoing it will be understood that line 3 is a test of line and cross-level of the track, sudden swings referring generally to alignment and slow swings to cross-level.

To a very large extent uncomfortable riding is due to side lurching or slogging of the car and every member of the track force should seek to improve the riding over the length to which he is attached so that line 3 will show very small oscillations.

BOUNCING LINE

Line 4, the lowest line on the chart, shows the vertical movement or the 'bounce' of the car as it travels over the track. When the needle moves down towards the bottom of the diagram it shows that the car has moved down and when the needle moves towards the top of the diagram it shows that the car has moved up.

Points of high oscillation are marked on the diagrams by the letters Q, R, S, T, U, and V, the explanations of which are given hereunder : -

Q - At mileages 25 M. 39 C., and 25 M. 56 C., in diagram 10, where the needle in each case makes a big oscillation, the initial part of the big movement is downward, showing that the car has dropped, and is followed by an upward movement of the needle which indicates the car has risen again to the normal level.

The cause of a single big oscillation like 'Q' with an initial downward movement indicates a loose or flogging sleeper or joint, a swinging cattle pit beam, or a badly worn crossing. The fault is an isolated one and should be attended to.

If it were continuous over some distance, the needle would make a series of oscillations as at places marked 'S'.

- R - In diagram 10 at 25 M. 10 C., an excessive oscillation has occurred with an initial upward movement. This has been caused by a high packing of the track.

When packing the track to take out a nip or a hole, it is the common practice for trackmen to pack the place above the general level of the track in order to allow for subsequent compression under traffic. If this were not done, the nip would very soon develop again as the packing compressed.

It is necessary, however, to make sure that the packing is not so high that the track will not come down at such a place to its proper level.

The same type of oscillation will be seen at 25 M. 29 C, (diagram 10), and also at 22 M. 47 C., (diagram 9, page 11.58).

- S - in the diagrams, indicates places where considerable vertical movement has taken place. The cause of this continuous bouncing is a poor top on the track due to bad or irregular packing of sleepers and crossing timbers, loose and worn fishplates, or nippy joints.

In many cases the top may be a false top, the fault causing high oscillation not being readily detected. In such cases the track should be either tested by striking the sleepers with a hammer or beater, or observed under traffic as directed in Instruction No. 425 of the Way and Works Book of Instructions : -

'Gangers and repairers when patrolling the length must take particular note of the behaviour of the track under loads of trains - that is to say, the movement of joints and sleepers, deflection of rails, point blades, stock rails and crossings, and general appearance of the permanent way under maximum loading must be specially observed.'

- T - At mileage 83 M. 29 C., in diagram 11, the needle has swung down to a lower level and has remained at the lower level for some distance before returning. This movement has nothing to do with joints.

Joints whether high or low are instantaneous errors in the level of the track and therefore are indicated by a sudden kick of the needle.

At 83 M. 29 C., the drop of the needle indicates a general drop of the car for the distance during which the needle remains at the low level. Here over a length of about 50 feet there is a sharp slack in the track.

- U - At mileage 83 M. 26 C., in diagram 11, the converse has taken place. The needle has risen and remained at the higher level for some time.

This movement shows a general rise or hump in the level of the track or presence of hog backed rails, the needle remaining in the higher position as long as the actual rise continues.

Normal gradients on the track will not affect the needle unless the change of grade is severe, and only severe rises and dips will be recorded.

Many of these changes to a higher or lower level cannot be avoided as they are necessary in giving clearances at bridges and runouts from places where lifting has been done, but in all cases the runout should be long enough to ensure that the drop or rise is not excessive. A similar oscillation will be noted at 83 M. 76 C.

- V - occurs in combination with 'C' in line 2, and 'P' in line 3, and has been explained previously. See 11.29 & 11.39.

GENERAL

Immediately after each test trip, copies of the charts will be forwarded to the District Engineer, Road Foremen and the Track Gangers concerned.

These charts will be marked in the manner shown in this book to indicate the locations which require attention.

In addition to the indications given on the chart a memorandum, as per sample on page 11.45, will show the locations where special attention to the track is necessary. This memorandum, which will also show if bad running has persisted for some time, must be returned promptly through the Road Foreman and District Engineer with a report showing the action that has been taken at each location to effect an improvement.

When the charts from a test trip are received they should be carefully studied, and with the information given in this book, the trackman will readily recognise the nature of the faults and determine their location on his track. Prompt action should be taken in every instance to remedy the defects.

By working at those places where swinging of the rolling needle, of the lurching needle or of the vertical needle was recorded, every member of the track force should endeavour to have the next chart very much better than the last one.

He should of course do this without neglecting the rest of his length. By remedying the defects in his length, the trackman will considerably improve its riding qualities, and he should strive for a perfect record - no high oscillations on any part of his length.

WEEDING

The importance of keeping the track free from weeds has been stressed in respect to track drainage, sleeper decay, fire hazard, and interference with lining and sighting operations.

Other reasons for weeding are the choking of engine ash arrestors and the slipping of driving wheels especially on grades where the grass fouls the rails.

Two methods of eradication are in use, mechanical and chemical.

MECHANICAL WEEDING

The general method of weeding by mechanical means is by tools of varying kinds such as ordinary picks, weeding picks, shovels, forks and hoes.

Weeding out of face though very desirable is not always practicable and attention may require to be paid to the more important sections first.

The approach to grades as well as the grades must receive early attention, and such portions of the track known to produce excessive weed growth by reason of ballast and other conditions should next be treated.

THE DISC WEEDER

This arrangement consists of two plough discs fitted to handles which are fastened to platelayer's trolley. The discs trail behind the trolley and the pressure on them is controlled by the men holding the handles to which the discs are attached.

When in use the trolley is hauled along the track, and the discs root out the weeds throwing them on top of the ballast. A finishing set of blades is substituted for the discs to level off the disturbed ballast after the weeds have been removed by rakes.

CHEMICAL ERADICATION

The use of chemicals for the destruction of weeds is common practice and has the merit of avoiding disturbance of the ballast and sleeper damage.

Care must be exercised in the handling and use of the chemical substances; arsenate of soda which is poisonous is not used on tracks through station grounds, over level crossings, at underway bridges or where the poison might pollute the feed and water supply for stock.

Calcium chlorate is non-poisonous and Weedex likewise; the effect of these chemicals is to suffocate the vegetation and special instructions are issued in respect to use.

Chemicals are applied in liquid form by the addition of water, both power and hand operated equipment being employed according to requirements.

As the liquid forms a slippery film on the rail surface, precautions must be taken to shield the rail from the direct action of the sprays.

CHIPPING

The danger of fire reaching the track necessitates the destruction of weeds adjacent to the tracks and when the cesses are being freed from weeds by the use of shovels a considerable loss of material will occur if the whole of the stripping is cast over the bank.

Generally it is preferable to let the weeds lie where chipped for a day or two and then gather them up by rakes, as by so doing the loosened earth is left on the cess where it is required.

VICTORIAN RAILWAYS

Office of Chief Civil Engineer, Melbourne

MEMO. - GANGER No.4 LENGTH Stony Point LINE

HALLADE TRACK TEST From 17 M. 00 C. to 21 M. 30 C. on 30.10.45

Herewith is forwarded a print of the Hallade Chart of the above test over your length showing locations where the track requires SPECIAL attention. These should be repaired and this sheet returned through the R.F. and D.E. to the above office within TWO months, with your remarks showing cause and action taken. Where a defect persists for more than SIX months a special report and recommendation will be required suggesting a remedy.

When locations requiring special attention are repaired the chart is to be used as your working plan for track maintenance and repairs carried out at other locations where indicated as necessary by the chart.

Chief Civil Engineer.

Approx. Mileage				Test on above date	Indications on previous tests.	Cause and action taken
From		To				
M.	C.	M.	C.			
Down						
18	19	18	20	S		Badly worn 'K' crossing - lifted to try and improve it.
20	11	20	19	Line		Rough approach to P.C.R. - lifted and pulled.
20	42	20	46	S		Series of nips - Lifted.
20	64	20	66	S		Series of nips - lifted.
21	13	21	16	S		Nips taken out and pulled.
UP						
17	21	-	-	Q		Loose rail - tightened.
18	75	18	77	Line N		Bad line each side of in- terlocked gates - pulled.
19	47	-	-	Q		Pit log swinging- lifted and packed.
21	23	21	30	Line & cant		Cant & gauge corrected.

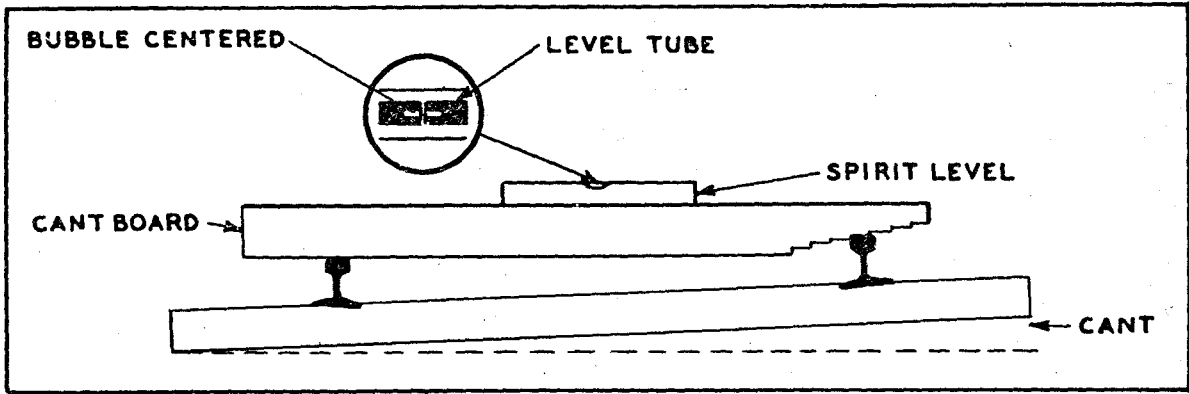

FIG.1. THE USE OF THE LEVEL AND CANT BOARD

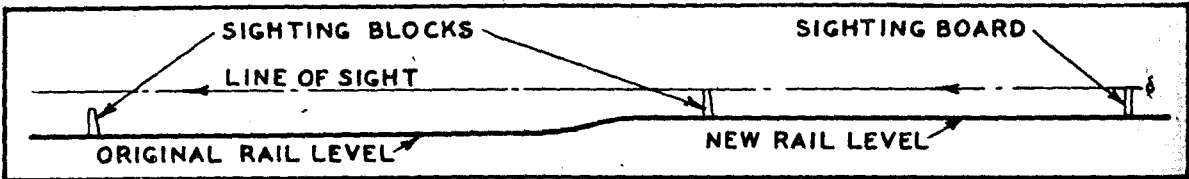

FIG.2. THE USE OF SIGHTING BLOCKS

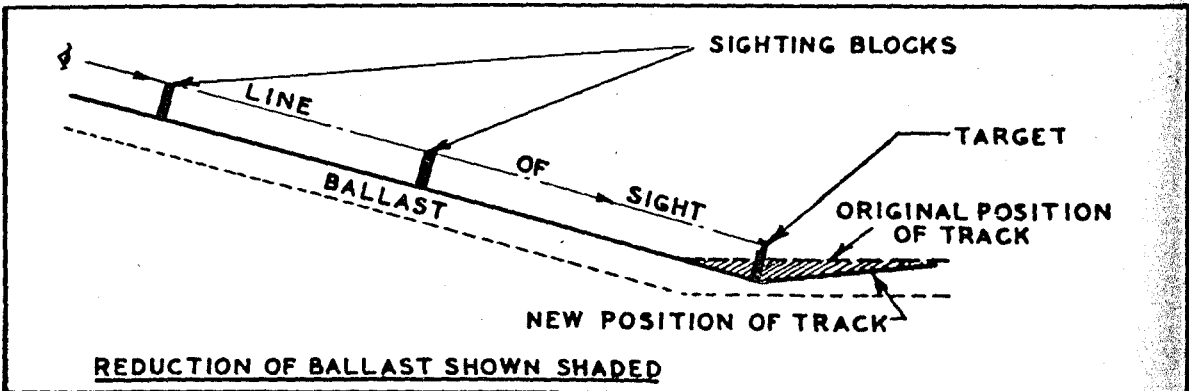

FIG.3. TARGET OVERLAPPING AT FOOT OF GRADE

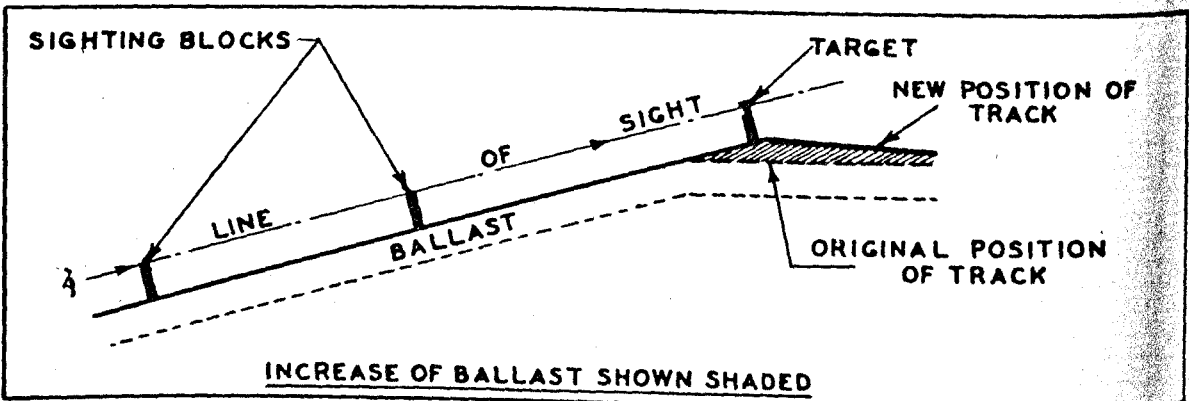

FIG.4. TARGET OVERLAPPING AT SUMMIT OF GRADE

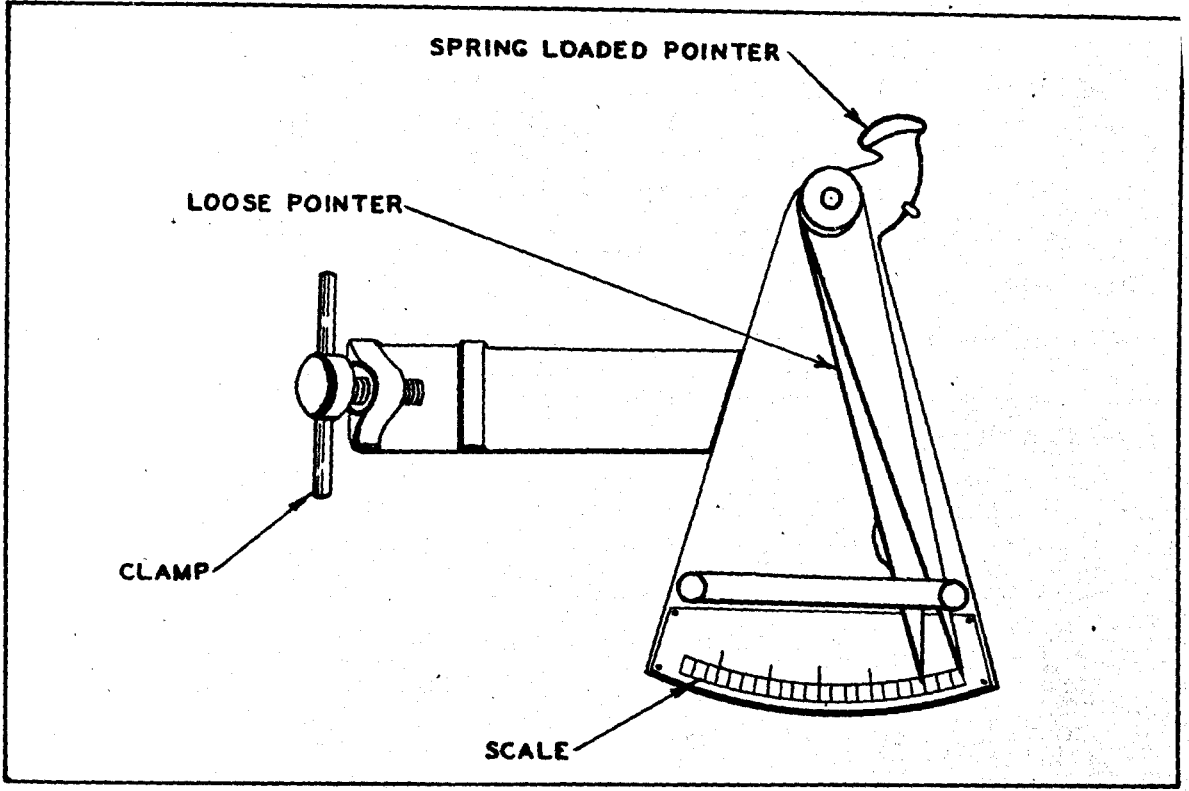

FIG. 5. THE VOIDMETER

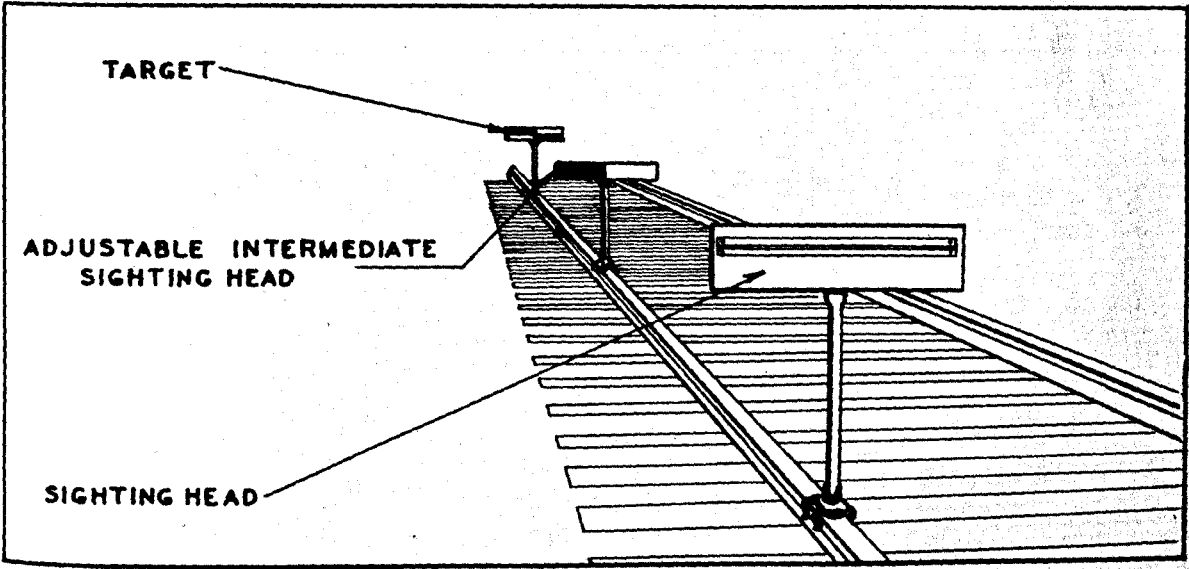

FIG. 6. THE SIGHTING HEADS & TARGET IN POSITION

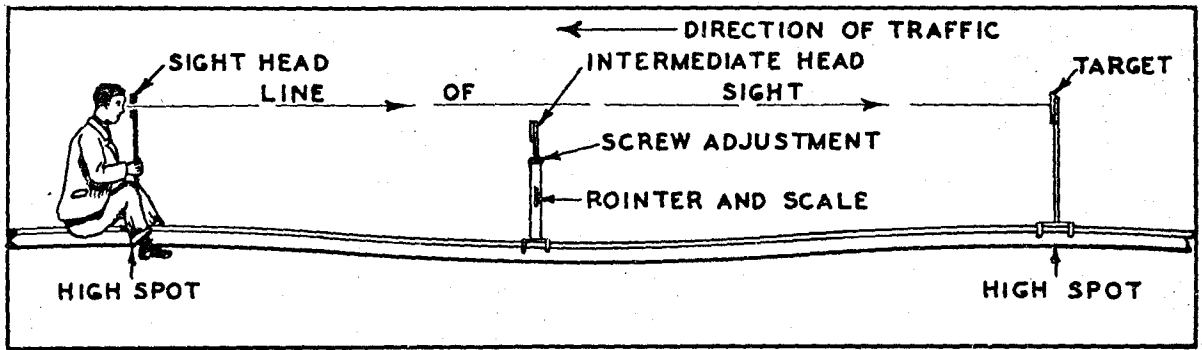

FIG. 7. MEASUREMENT OF A STATIC DEPRESSION

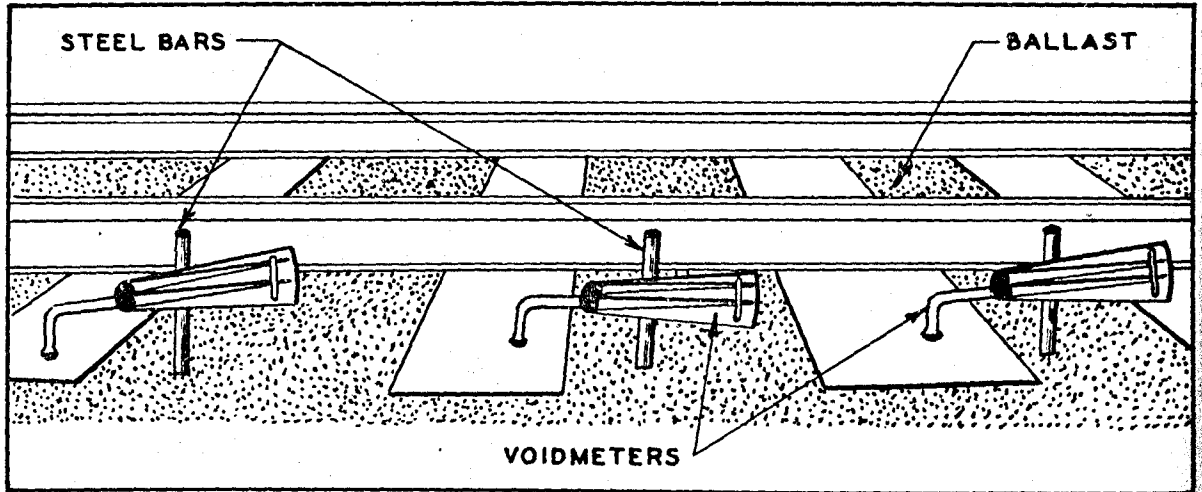

FIG. 8. VOIDMETERS IN POSITION

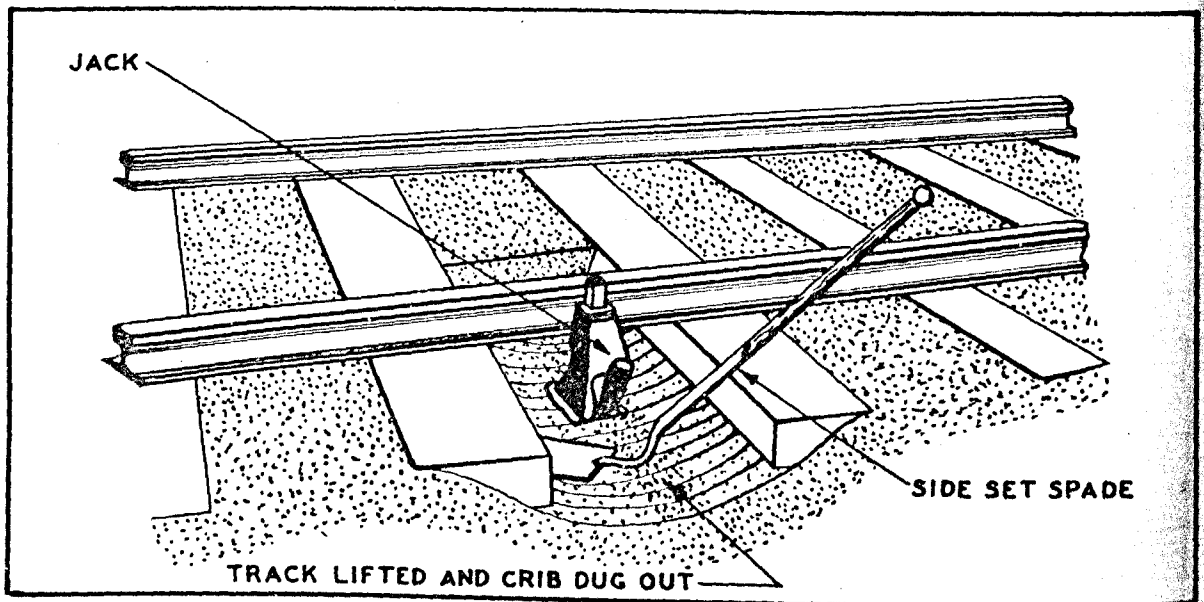

FIG. 9. THE USE OF THE SIDE SET SPADE

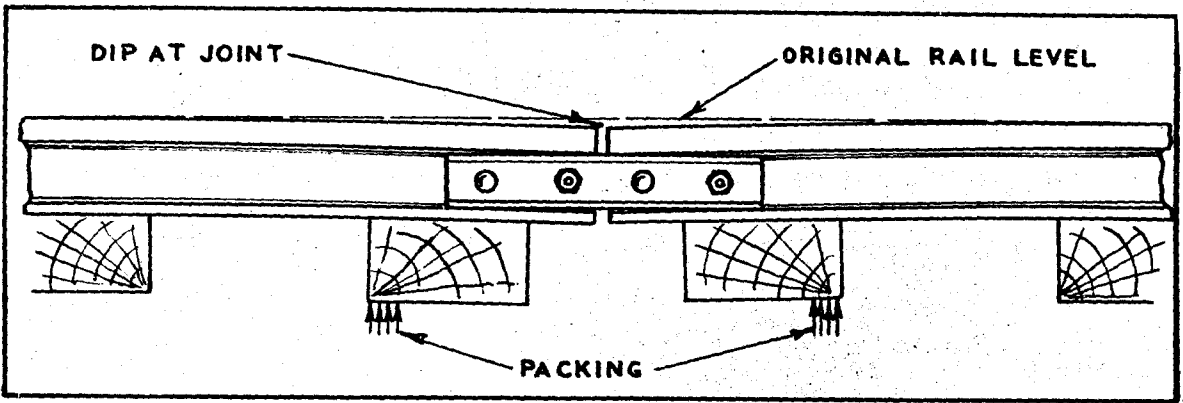

FIG.10. THE EFFECT OF PACKING ONE SIDE OF THE JOINT SLEEPER

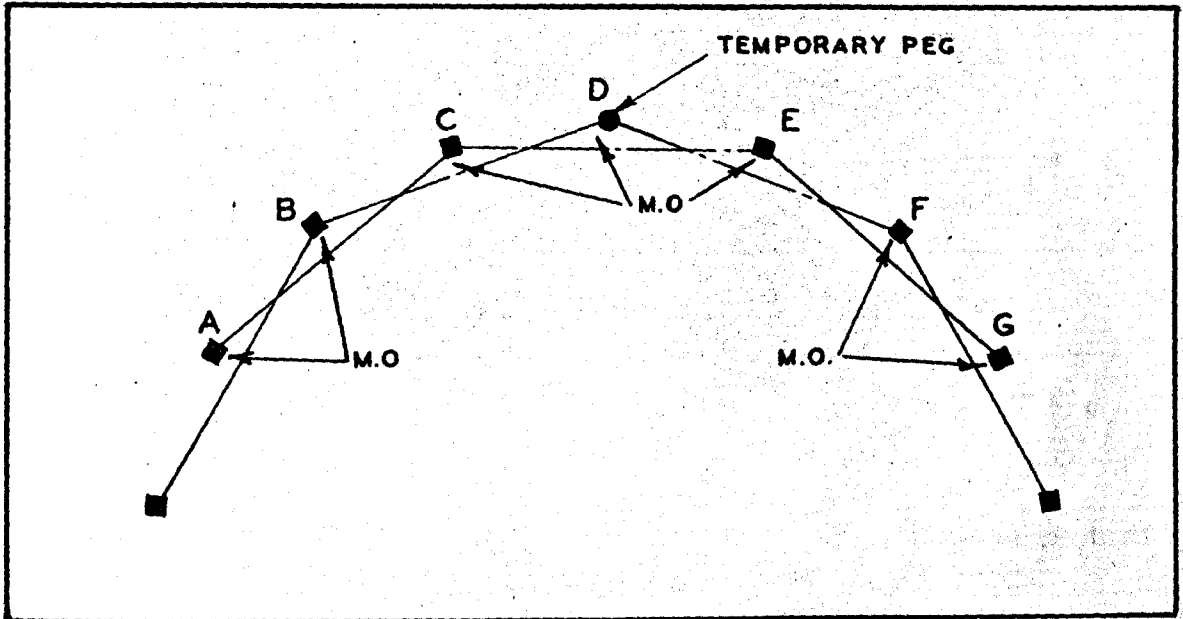

FIG.11. METHOD OF LOCATING A MISSING CENTRE LINE PEG

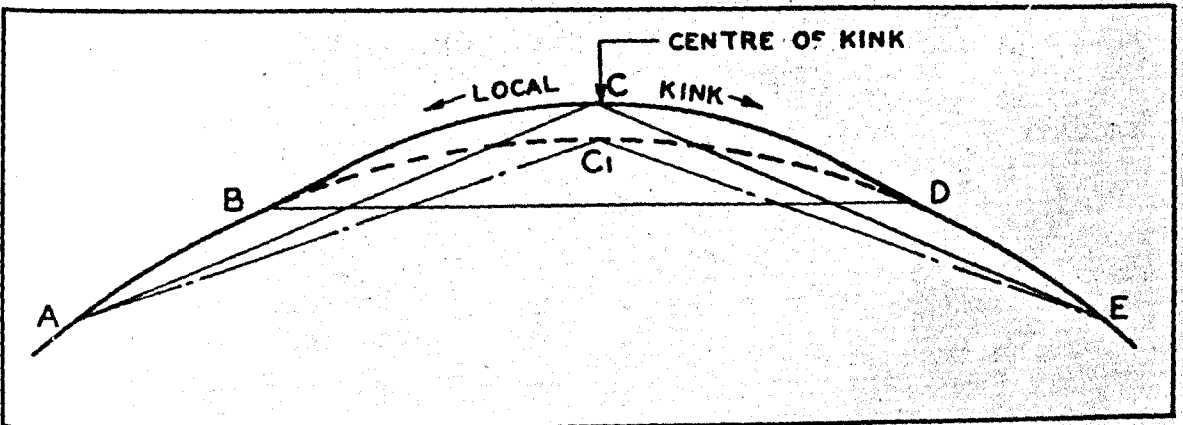

FIG.12. CORRECTION OF ALIGNMENT AT A KINK

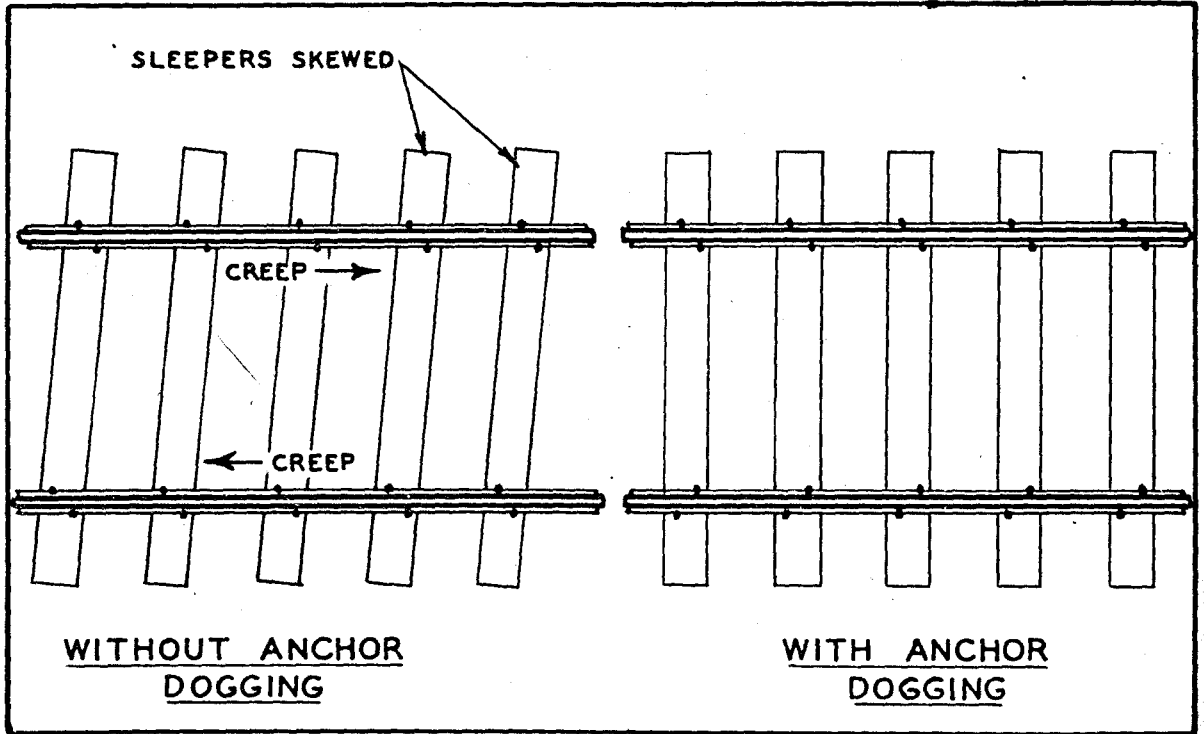

FIG.13. SKEW OF SLEEPER PREVENTED BY ANCHOR DOGGING

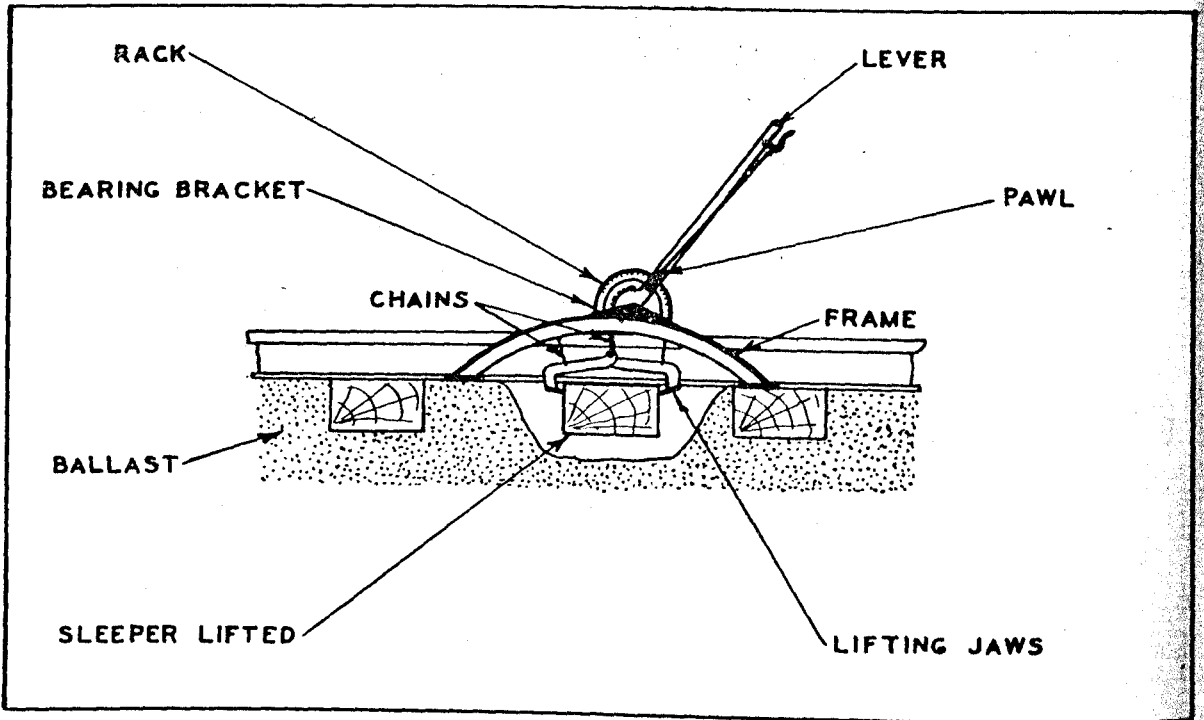

FIG.14. THE SLEEPER NIPPER

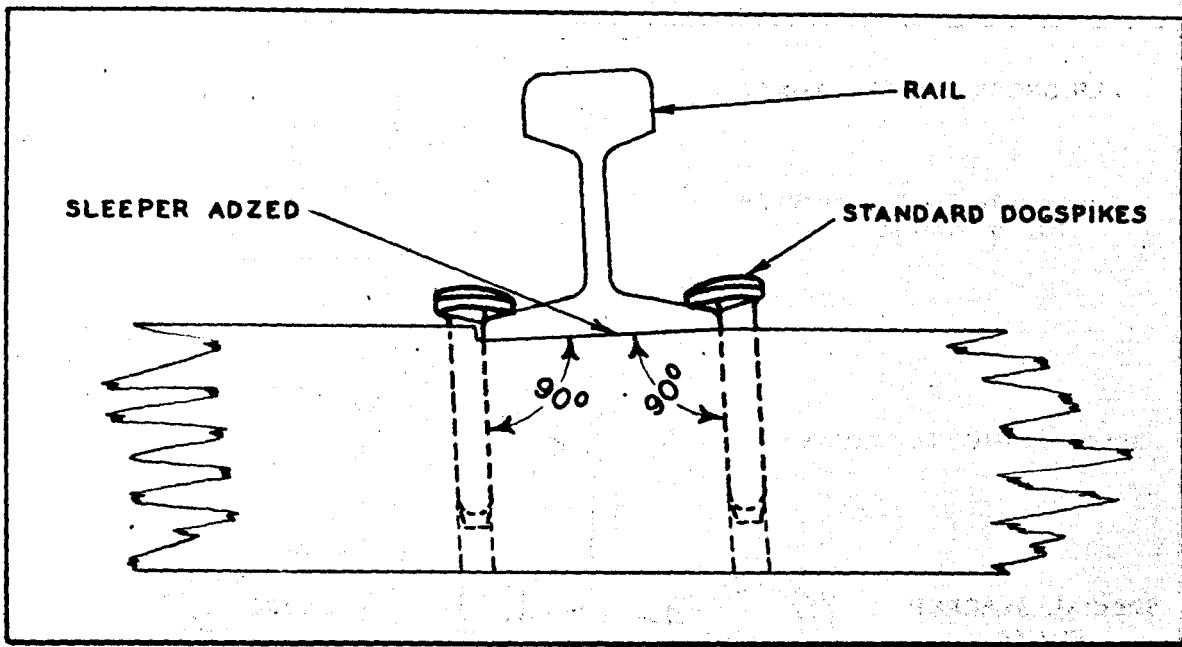

FIG.15. THE STANDARD DOGSPIKE -METHOD OF DRIVING

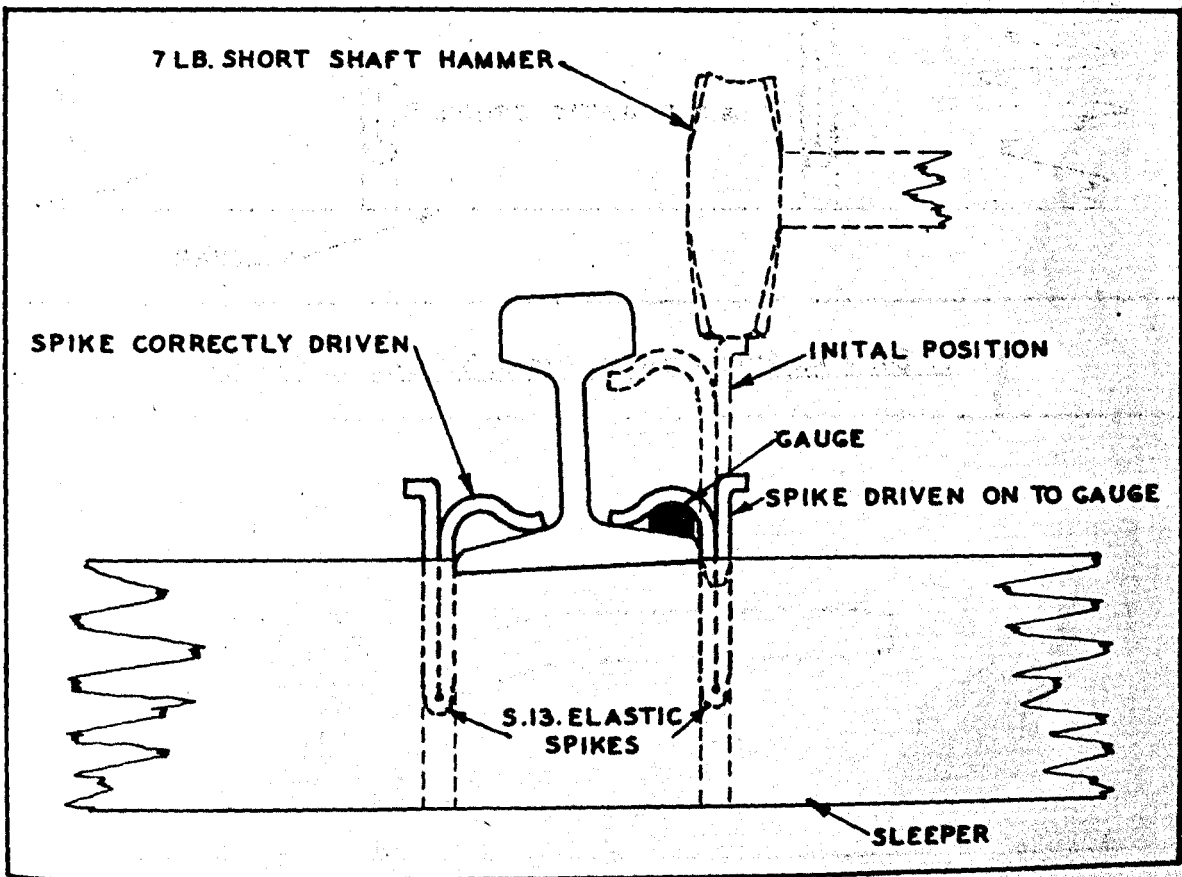

FIG.16. DRIVING POSITION OF THE S.13. ELASTIC SPIKES

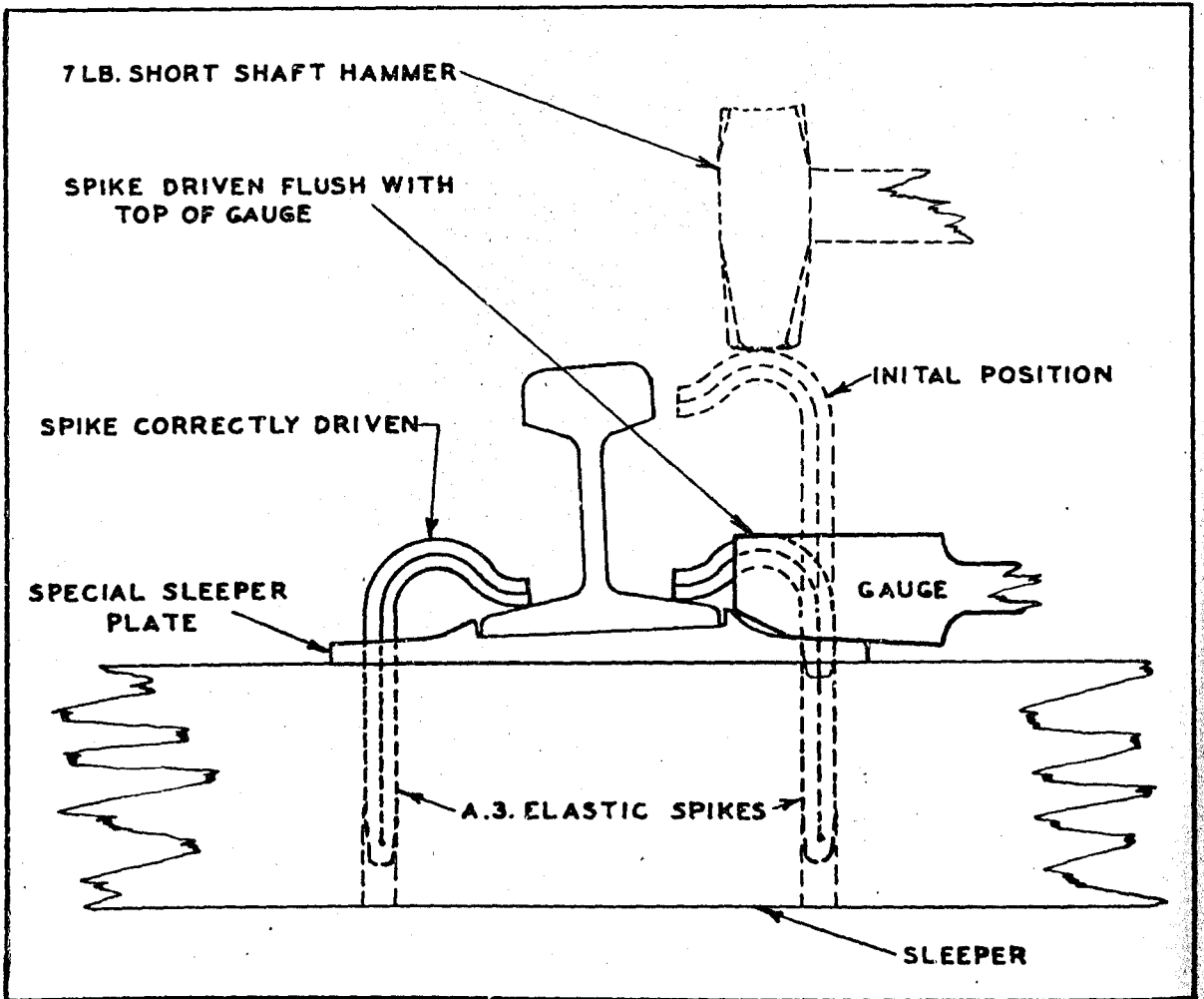

FIG.17. DRIVING POSITION OF THE A.3. ELASTIC SPIKES

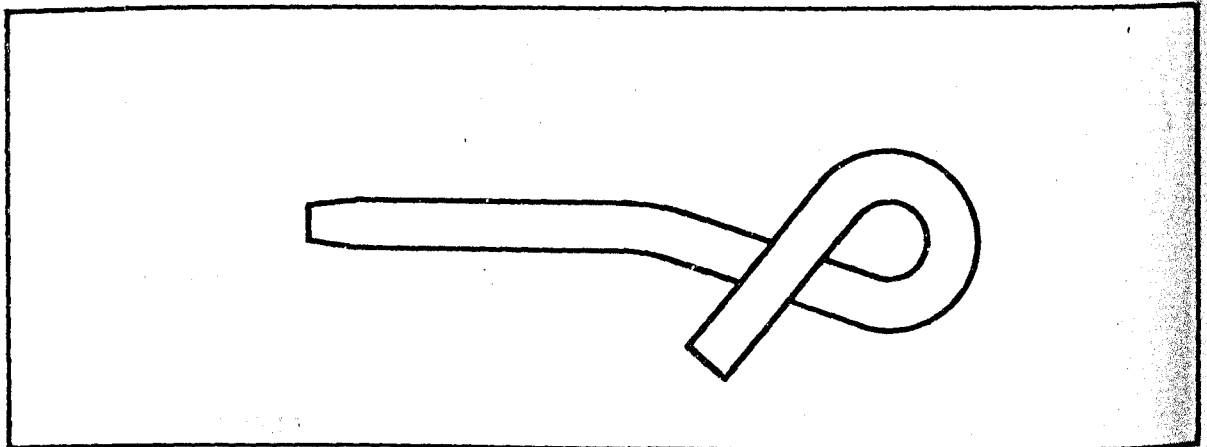

FIG.18. THE MILLS ELASTIC SPIKE

FIG.20. THE HALLADE MACHINE

REAR VIEW COVER REMOVED SHOWING
PENDULUM

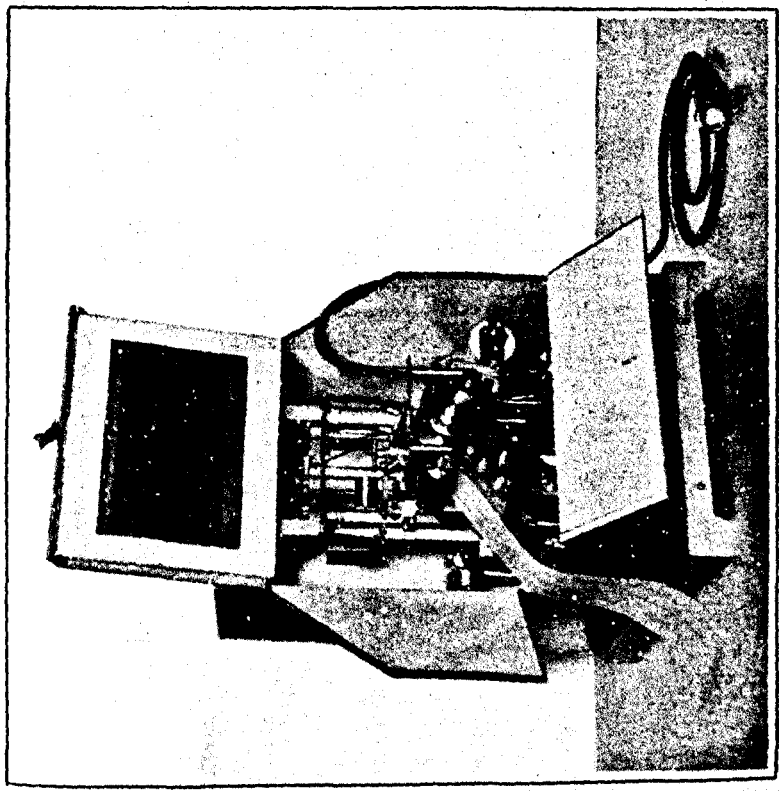
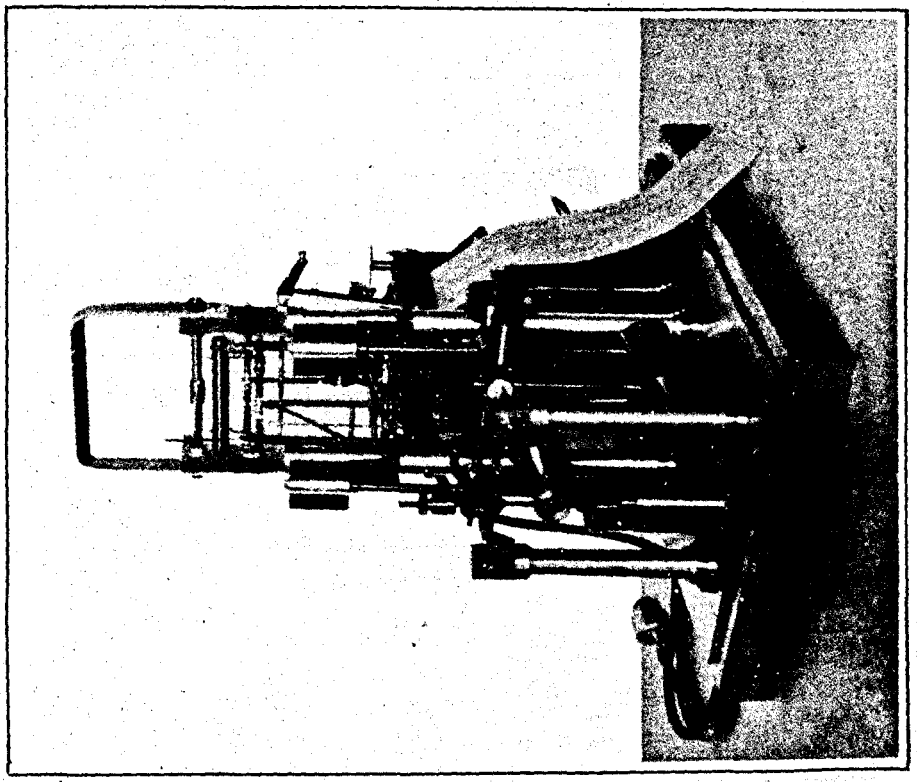
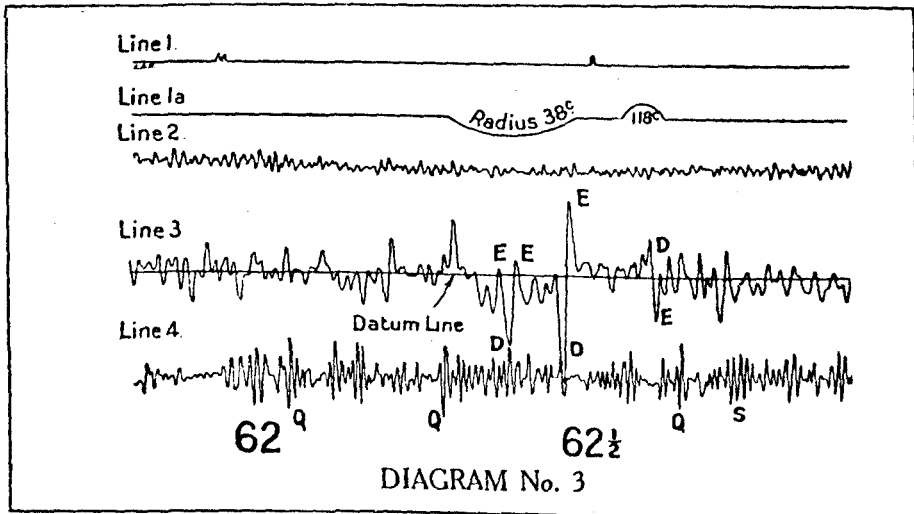
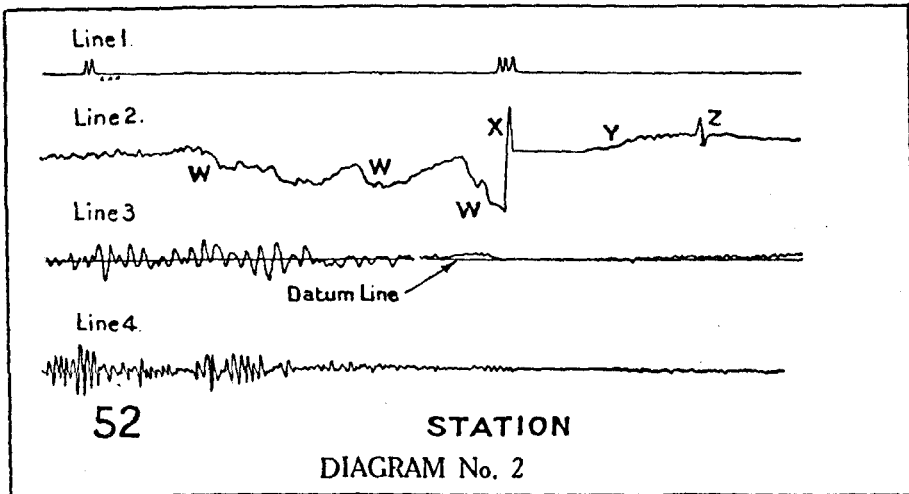
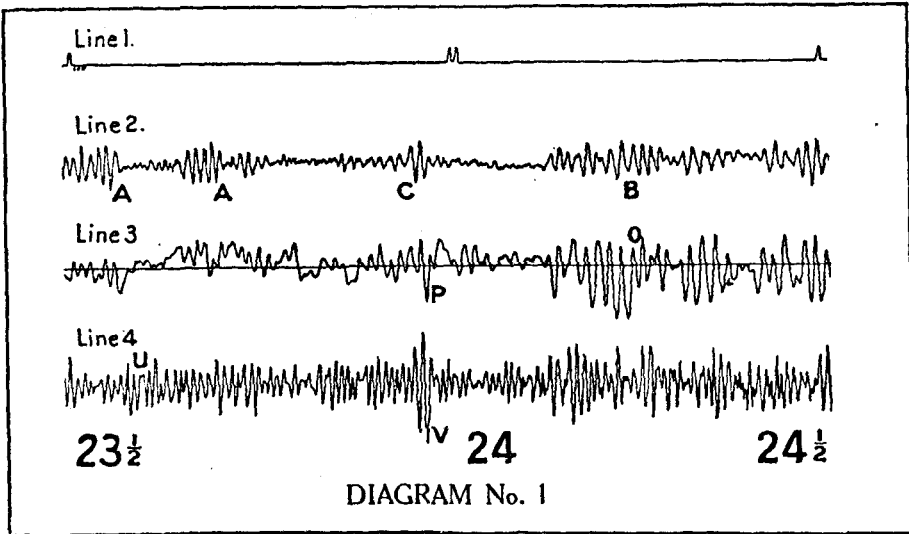

FIG.19. THE HALLADE MACHINE

FRONT VIEW SHOWING CHAIN DRIVE TO
DRUM AND PAPER



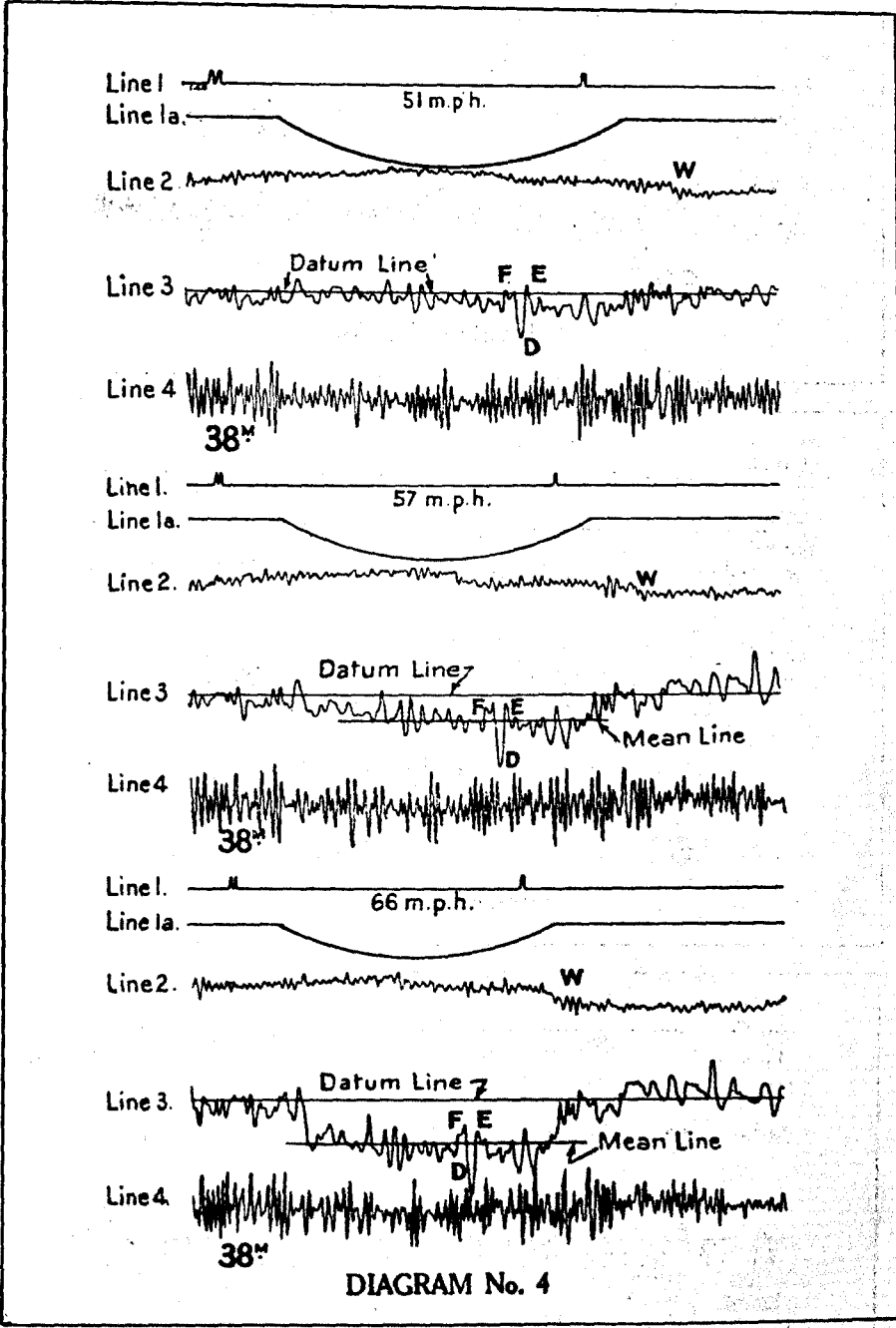
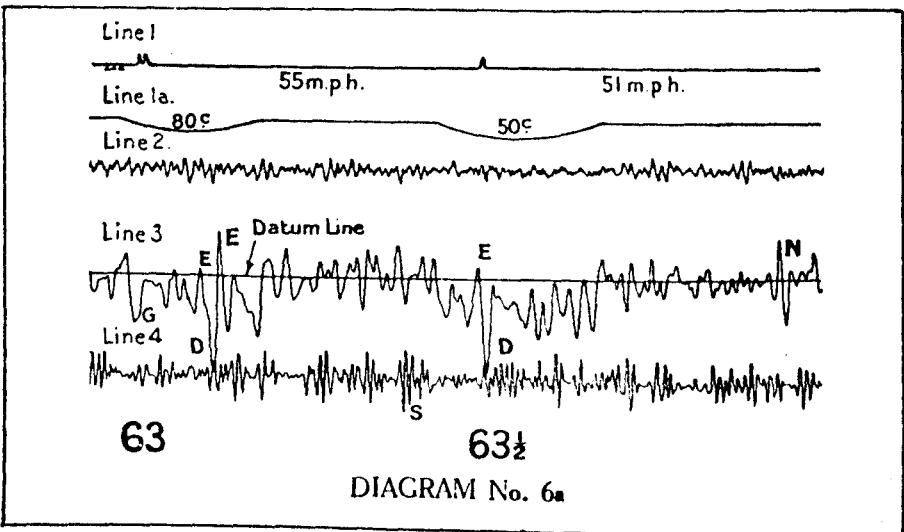
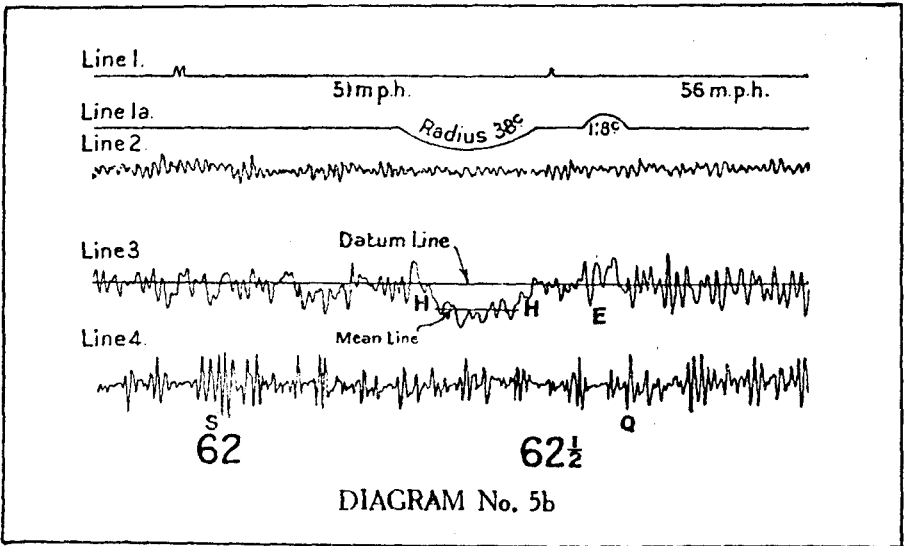
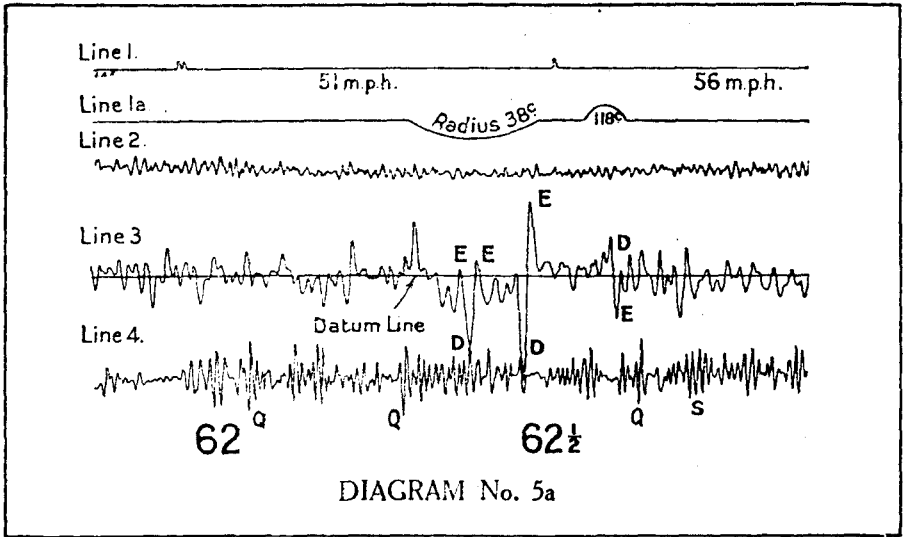
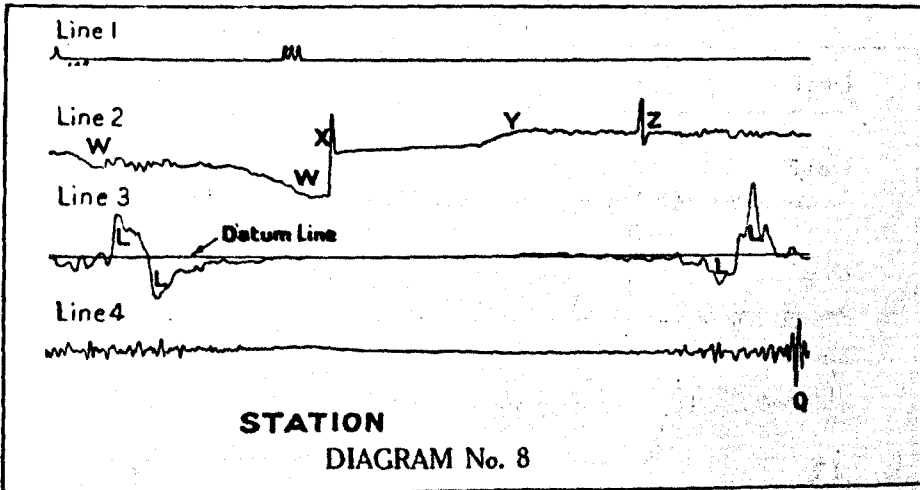
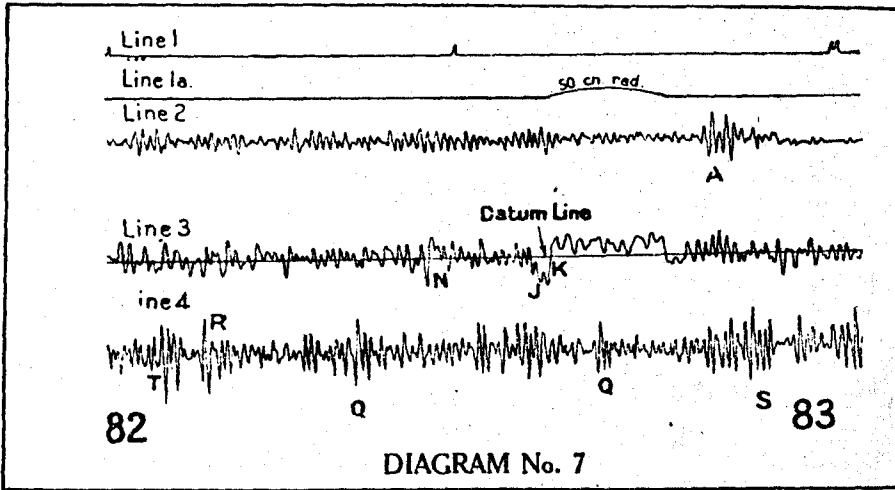
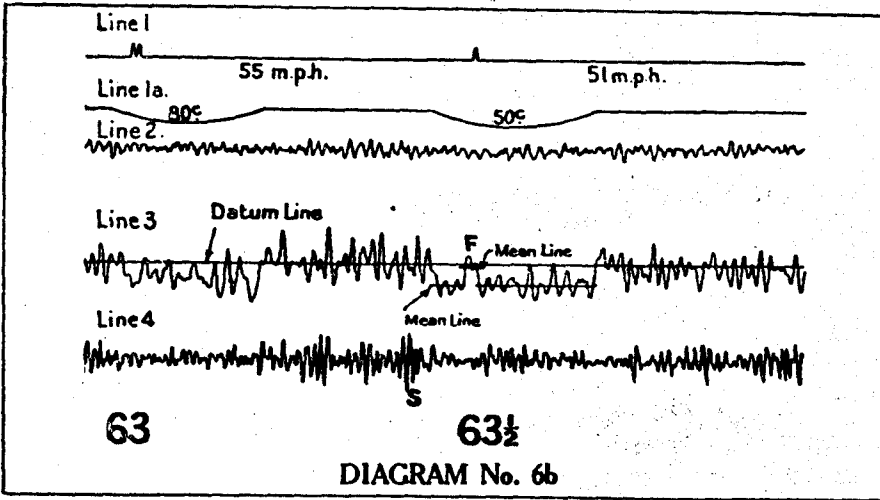
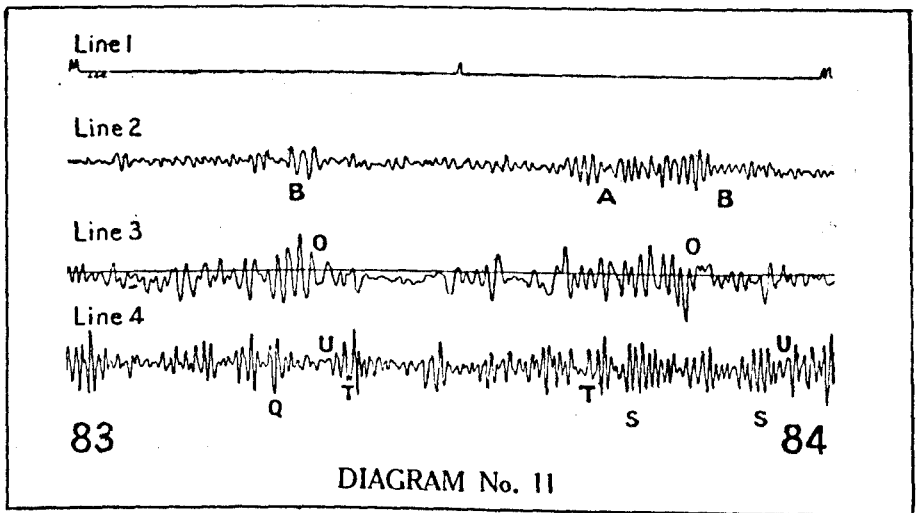
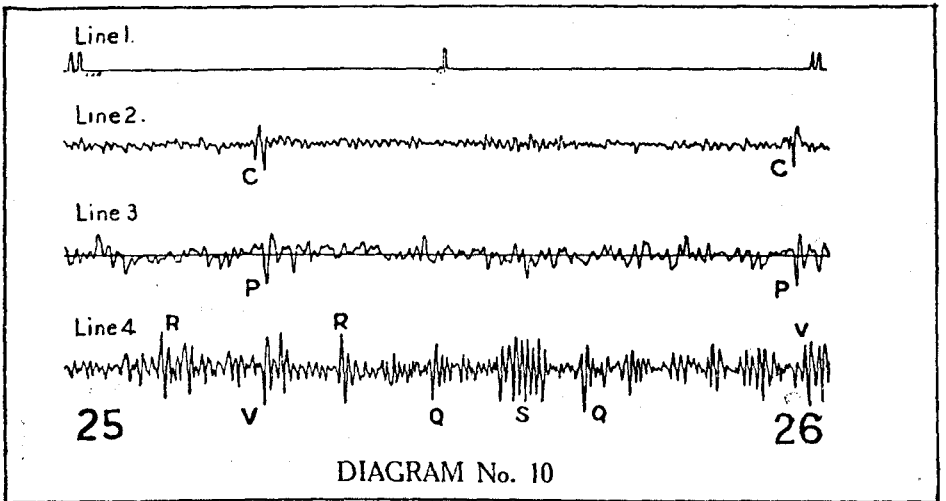
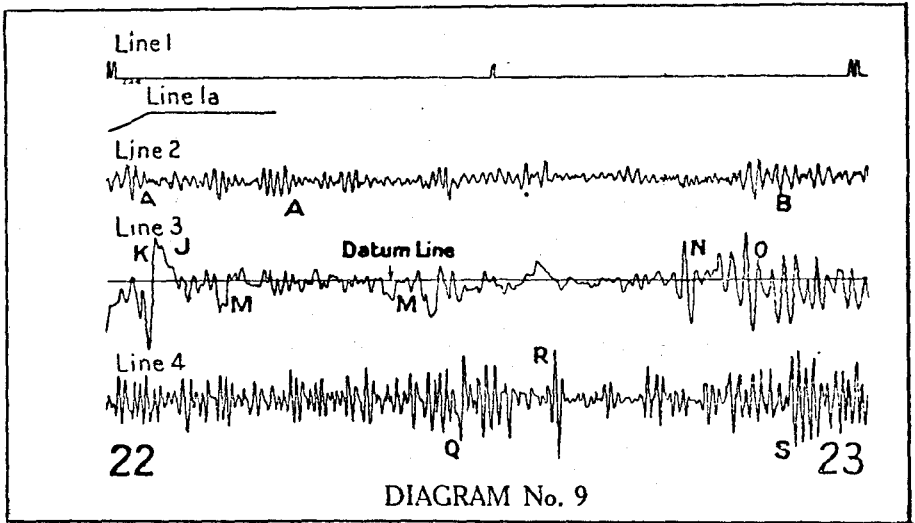

DIAGRAM No. 4







RELAYING TRACK. 12.

DEFINITION

Re-laying track comprises the substitution of existing rails with other rails, new or serviceable, of the same or of a different class and section.

The re-laying of main tracks invariably involves the use of new and heavier rails to meet the increase in speeds and axle loads dictated by public requirements. Re-laying of secondary tracks generally involves the substitution of the existing rails with heavier serviceable rails released by the re-laying of main tracks.

Rails released from main tracks and secondary tracks are used to re-lay sidings according to the density of traffic being handled. Released rails are classified according to section, length and condition, and those suitable for re-laying are now generally welded to suitable lengths to meet requirements for straight or curved tracks and sidings.

Re-laying with rails of a different class and rail length necessitates a re-distribution of sleepers, and this is usually accompanied by sleeper renewals. When the ingoing rails are sleeper plated the whole of the sleepers may require to be renewed as the seating of sleeper plates on adzed sleepers is generally impracticable.

ADZING

On secondary tracks, where adzed sleepers are used, the change in rail section may involve an alteration in the width of adzing, the position of dogspikes and the distance between saw cuts of the adzing planes.

The dogspike holes which cannot be re-used must be plugged with wooden plugs and these be adzed off to a fair face with the sleepers.

If angle fishplates are used an additional width of adzing is required at the new joint sleepers; in any case the position of the joints will not coincide with the existing joint sleepers because of the different length of the ingoing rail.

The variations in width of adzing, and the distance between inner edge of rail flanges when laid to neat gauge for the rails commonly in use are as follows : -

Measurements are to nearest $\frac{1}{8}$ " between flanges with a rail inclination of 1 in 20.				
Weight and class of rail	Height of rail (inches)	Width of flange (inches)	Width of flange (inches)	Distance between inner edges of flanges.
60 D	4.3/8	4 $\frac{3}{8}$	2 $\frac{1}{4}$	5'1 $\frac{1}{4}$ "
60 AS	4.1/2	4 $\frac{1}{4}$	2 $\frac{1}{2}$	5'1 $\frac{5}{8}$ "
75 H	4.7/8	4 $\frac{3}{4}$	2 $\frac{1}{2}$	5'1 $\frac{1}{4}$ "
80 'O', 80 AS	5.1/4	5	2 $\frac{3}{4}$	5'1 $\frac{1}{4}$ "
90 AS, 94 AS	5.9/16	5	2 $\frac{3}{4}$	5'1 $\frac{1}{4}$ "
100 P, 100 AS	6	5 $\frac{3}{4}$	3	5'0 $\frac{3}{4}$ "
107 AS	6.3/16	5 $\frac{3}{4}$	2 $\frac{3}{4}$	5'0 $\frac{1}{2}$ "
110 AS	6.7/32	5 $\frac{3}{4}$	3	5'0 $\frac{7}{8}$ "

When dealing with rails not listed the following rules will give the required distance : -

1. When rails are to gauge and level the distance between inner flanges is equal to : -

$$\text{Gauge} + \text{width of head} - \text{width of flange.}$$

2. The distance which flanges move outward when rails are canted 1 in 20, retaining gauge distance $\frac{5}{8}$ " below the top of the rail, is equal to : -

$$\text{Effective height (total height - } \frac{5}{8} \text{") } + 10$$

This distance has then to be added to the distance between flanges when rails are level. See 8.07 & 15.11.

RELATED WORK

As the purpose of re-laying a stretch of track is usually to strengthen it for present and future traffic requirements, attention must be paid to width and condition of formation, and sufficiency and condition of the ballast.

Frequently this work will involve : -

1. Widening of the formation, bank building and excavation in cuttings, and attention to sub drainage.
2. Re-grading or corrections of grades owing to subsidence and the introduction or correction of vertical curves.

3. Re-alignment of track, alterations of transition curves, re-centering of horizontal curves and correction of cant are other matters generally undertaken at the time of re-laying.

4. Re-ballasting.

Under traffic conditions the various stages of the work must be arranged to offer the minimum interference with traffic and the work is generally divided into two sections - preparatory and complementary.

PREPARATORY WORK

Bank making and widening of cuttings to widen the formation is the first work undertaken and this is followed by cross drainage and general drainage as required. The nature of this work is shown in 5.01 - 5.08 & 6.01 - 6.04.

Re-railing, re-sleepering, ballasting, lifting, surfacing, lining, boxing up and trimming follow, usually in this order.

Before the track is disturbed for other than drainage purposes, the new material would be laid out on the ground adjacent to its intended position in track, or at least sufficient of it with which to carry on.

The manner of carrying out the work will depend largely on the local conditions, the strength of the gang and equipment engaged on the work.

All safety precautions laid down by Rules and Regulations, Way and Works Instructions and other special instructions must be strictly observed.

If bonding for electric current is in use, the Bonding Supervisor will attend to this work, but he must be advised previously to enable co-operation with the re-laying gang.

The total length of continuous track on country lines to be temporarily prepared in re-laying must not at any time exceed forty (40) chains.

To facilitate the removal of the old rails and the ingoing of the new rails, the ballast should be cleared away to at least an inch below the level of the sleeper tops.

The nuts on the fishbolts should be backed off and the two nuts at the centre of the joints be tightened sufficiently to hold the joints for the passage of trains at reduced speed.

At the point of break the nuts on the centre bolts should be run off, two spring washers should be installed on each centre bolt and the nuts be replaced and tightened to hold the joint.

On straight track two out of every three dogspikes may be removed on the outside of the rail flanges of both rails and two out of every three dogspikes may be started on the inside of the rail flanges of both rails, as shown in Fig.1.

On curved track alternate dogspikes on the outside of the rail flanges of both rails may be pulled half out of the sleepers, but the mating dogspikes on the inside of the rails should not be disturbed. Alternate dogspikes or rail pins may be started on the inside of both rails as shown in Fig.2.

If the security dogspikes are eased and driven back to the rail flange delays will be avoided in removing difficult dogspikes when the break is effected.

The ingoing rails may be fished together on the out ends of the sleepers, nuts on fishbolts be tightened sufficiently to hold the required expansion spaces, and the rails be temporarily held in position by partly driven dogspikes at intervals as necessary. To protect the rail ends from fouling anything trailing from trains, a tapered block of wood should be fixed as shown in Fig. 3.

Prior to linking in, any unevenness of the sleeper tops, owing to shelling off or cocked ends, should be adzed off to enable the rails to seat evenly and slide into position without lifting.

Junction fishplates required to connect rails of different sections should be checked to establish that the weight, class and hand are correct and, if practicable, should be tried on the rails to ensure that they will fit snugly and bring the rail into true alignment.

The junction rail, (See 10.06), re-laying switch (rarely used), or closure rail and junction fishplates should be similarly checked over to ensure that trouble will not arise in linking in at the finishing end of the break.

COMPLEMENTARY WORK

When it is clear that everything is in readiness for the work of re-railing to proceed and the flagmen have been duly instructed and posted, the old rails may be unfished at the ends of the break.

The remaining outside dogspikes are drawn and the inside dogspikes started or removed according to the position of the ingoing rail.

For the purpose of pulling new rails into position the break on country lines must not exceed twenty (20) chains, and the gangs may therefore be profitably employed in the preparation of track on a further twenty (20) chains while awaiting possession of the track.

As the old rails are slewed over the top of the new rails, the preparation of the sleepers for the new rail seat will be put in hand. When the necessary plugging and adzing have been completed to receive the new rail, all chips and grit must be cleared along the length of prepared sleepers to ensure that the ingoing rail will seat snugly in position.

Gauging, boring, and spiking follow, in this order, and adjustment of expansion as found necessary, and anchorage.

After the new rails are in running the released rails are unfished, the nuts run on each fishbolt and the fishbolts placed in tins or other receptacles ready for loading. Fish-plates are usually left where they have been unfished as the loading can be readily performed on each side of the train when the rails are being placed on the trucks.

A point to be remembered in re-railing is that it is generally unwise to release both rails simultaneously as the sleepers are liable to become displaced endways and cause much trouble by the inside dogspikes hindering the placing of the ingoing rails in position.

ADJUSTING EXPANSION

The practice of bumping rails to correct the expansion is irregular and can result in damage to the rails and fastenings; for this work the Rail Joint Adjuster should be used. See 15.05.

ANCHORAGE

As soon as the rails are spiked, the necessary anchorage should be applied to prevent creep, and in the case of long welded rails to control the contraction at the ends of the rails. See 3.05 & 9.18.

STRENGTHENING TRACK

If re-sleepering is to be done it should be put in hand as early as practicable after re-railing, otherwise the new rails are likely to be damaged because of deficient sleeper support.

To interlace the new sleepers the ballast must be cleared away to the bottom of the sleepers, and when very dirty it is usual to spread this ballast to build up depressed cesses or truck it to other sites for roadways in station yards. Sometimes ballast may be forked back.

As the spacing of the new sleepers will usually differ from the old spacing, it is essential that the old sleeper beds be thoroughly broken up to allow even settlement of the track.

On a country track a light lift would be given, and after alignment the ballast would be boxed up and trimmed, but in the suburban area, owing to the overhead wiring and structures, no general lifting is permitted without authority from Head Office.

In suburban work it is frequently necessary prior to re-sleepering to block up the track on baulks of timber and strip the whole of the ballast.

When the anchorage is controlled by the dogspikes at angle fishplates or pin holes at the joint sleepers, the expansion adjustment should be carried out before boxing up about the joint sleepers.

Sometimes the re-laying gang is split into two divisions, the first doing the preparing and re-railing, while the second does the re-spacing, re-sleepering, lifting, boxing up, etc. Work done in this manner is more specialised and its claim of lower initial cost may be allowed.

In practice, however, the tendency is for the first division of the re-railing gang to out-pace the sleepering gang, unless they are properly regulated, and the farther apart they become the greater the liability of rails creeping and permanent sets or kinks developing in them.

Again, as the re-railing gang's interest ends with the placing and securing of the rails in the track, it is unlikely that it will be as careful in seeing that no kinked rails are put into running as it would be had it to complete the job itself. Further, as it is chiefly concerned with quantity and not quality, other important matters such as plugging, boring, and bolt-tightening, are unlikely to receive the same considered attention as when the same set of men completes the work.

LAYING RAILS

As slight variations are permitted in the fitting position of fishplates in the fishing angle of the rails, the joints may not be in true alignment if rails are laid without attention to the position of the rolling brands. For this reason rails are laid with the rolling brands outside the gauge. See 9.05.

EXPANSION SPACES

The expansion available in the latest Australian Standard rail joints is $3/8$ ", ~~44~~ inches per mile with 45'0" rails.

Considering the rail ends in contact as shown in full lines in Fig. 4, it will be seen that the space between the shank of the bolts and the side of the bolt holes in the rail webs is $3/16$ ". Each rail end may therefore contract $3/16$ " and the joint may therefore open $3/8$ " before the rail webs contact the bolts.

Any further opening of the expansion space is only possible by bending the bolts, although a small fraction of movement is possible between the bolts and the fishplates according to accuracy of manufacture and subsequent wear.

SHORTENING RAILS ON CURVES

The length of rail required for the inner rail of curved track is less than that required for the outer rail of curved track. If rails of the same length were laid commencing with the ends square with the track, the inner rail would lead the outer rail at the first joint by some distance, according to the radius of the curve and the common length of the rails being laid.

It is usual to allow the lead to increase up to one half the pitch between the fishbolt holes and then to shorten the next inner rail by one full pitch. The purpose of shortening by one full pitch is to correctly maintain the position of the remaining bolt holes with respect to the cut end of the rail.

If the curve is laid by working in pitches and half pitches, the lead alternates from the inner to the outer rail and back to the inner rail, but never exceeds one half of the pitch.

When bar type and flat fishplates are used the lead does not affect the joint sleepers which are laid square to the track, but with notched angle fishplates, the joint sleepers must be skewed by the amount of the lead to enable the dogspikes at the joint to be driven in the notches of the fishplates.

The presence of insulated joints in the inner and outer rail at the same location requires that the two joints shall lie opposite without lead.

$$\text{Lead} = \frac{\text{Length of outer rail}}{\text{Radius of outer rail}} \times (\text{Gauge} + \text{Width of rail head})$$

It will usually be found convenient to express the length and radius of the outer rail in feet and the gauge and width of rail head in inches, the lead is then in inches.

LONG WELDED RAILS

Example : - What is the lead at the first joint when 94 lb. rails 225' long are laid on a curve of 80 chains radius.

$$\begin{aligned} \text{Rad. of outer rail} &= \text{Centre line rad. of curve} + \text{Half the gauge} \\ &= 5280 \quad + \quad 2.625' \\ &= 5282.625' \end{aligned}$$

$$\begin{aligned} \text{Gauge} + \text{Width of head} &= 63'' + 2.75'' \\ &= 65.75'' \end{aligned}$$

$$\begin{aligned} \text{Lead} &= \frac{225}{5282.625} \times 65.75 \\ &= 2.80'' \end{aligned}$$

The total lead for a number of even length rails is found thus : -

$$\text{Total lead} = \text{Number of rails} \times \text{Lead on one rail length}$$

$$\text{Number of shortened rails} = \frac{\text{Total lead}}{\text{Pitch of fishbolt holes.}}$$

Pitch of fishbolt holes in 94 lb. rails is 5".

If in this example the outer rail is laid with 9 No. 225' rails,

$$\text{Total lead} = 9 \times 2.80 = 25.20 \text{ inches}$$

$$\text{Number of shortenings} = \frac{25.20}{5} = 5.04$$

This should be taken as 5 shortened rails as the decimal part is less than one half and the lead is not to exceed half the pitch.

To locate the rails it is convenient to tabulate the progressive leads and shortenings thus : -

Joint No.	Progressive Lead. + .	Progressive Shortening.-.	Lead on Joints.
0	0	0	0
1	2.80	5	-2.20
2	5.60	-	+ .60
3	8.40	10	-1.60
4	11.20	-	+1.20
5	14.00	15	-1.00
6	16.80	-	+1.80
7	19.60	20	-0.40
8	22.40	-	+2.40
9	25.20	25	+ .20

The + (plus) sign indicates that the inner rail is further ahead at the joint, whereas the - (minus) sign indicates that the inner rail is behind at the joint; the position is, of course, relative to the joint positions of the 225' rails in the outer rail of the curve. See Fig. 5.

In the example no account has been taken of inaccuracy of rail lengths, and from a practical viewpoint the necessary adjustments can usually be made as the rail is being laid in by using the track square at each joint and when the inner rail leads by more than 1/2 the pitch between fishbolt holes by shortening it by one pitch length.

MILL LENGTH RAILS

When laying standard mill length rails with corresponding short rails, as for instance 45'0" with 44'7" rails, it is necessary to know the number of short rails required and the sequence in which they should be laid, as this enables the rails to be laid out adjacent to their correct positions for installation in track.

Example : - What is the lead at the first joint when 100 lb. x 45' rails are laid on a 30 chain radius curve.

$$30 \text{ chains} = 1980 \text{ feet.}$$

$$\begin{aligned} \text{Lead} &= \frac{\text{Length of outer rail}}{\text{Radius of outer rail}} \times (\text{Gauge} + \text{Width of rail head}) \\ &= \frac{45}{(1980 + 2.625)} \times 66 = 1\frac{1}{2} \text{ inches} \end{aligned}$$

12.10

If 23 chains of curve is to be laid with 45' and 44'7" rails, find the number of rails required and the order in which they should be laid so that the lead at any joint will not exceed $2\frac{1}{2}$ inches.

$$\text{45' rail required in outer leg of curve} = \frac{\text{Length of curve}}{\text{Length of rail}} = \frac{23 \times 66}{45} = 33.73$$

As the rails are not an exact number, the nearest exact number should be laid to avoid cutting new rail, therefore take 34 No. 45' rails in outer leg of curve.

$$\begin{aligned} \text{The total lead} &= \text{Number of rails} \times \text{Lead on one rail length} \\ &= 34 \times 1\frac{1}{2} = 51 \text{ inches} \end{aligned}$$

$$\text{Number of short rails} = \frac{\text{Total Lead}}{\text{Shortening}} = \frac{51}{5} = 10.2$$

This should be taken as 10 short rails as the decimal part .2 is less than $1/2$ (.5) of the allowable lead.

To locate the rails a tabulation is necessary as follows :-

Joint No.	Progressive Lead. + .	Progressive Shortening.-.	Lead on Joints.
0	0	0	0
1	$1\frac{1}{2}$	-	$+1\frac{1}{2}$
2	3	5	-2
3	$4\frac{1}{2}$	-	$-\frac{1}{2}$
4	6	-	+1
5	$7\frac{1}{2}$	-	$+2\frac{1}{2}$
6	9	10	-1
7	$10\frac{1}{2}$	-	$+\frac{1}{2}$
8	12	-	+2
9	$13\frac{1}{2}$	15	$-1\frac{1}{2}$
10	15	-	0

The tabulation need be extended no further than the point when the lead on the joints again becomes zero; this indicates that the 44'7" rails are laid in a series of 10 rails in which the 2nd, 6th, and 9th rails are 44'7" and the 1st, 3rd, 4th, 5th, 7th, 8th, and 10th rails are 45'0" long.

The series is again repeated for the balance of the curve as shown in Fig. 6.

The lead of joint and the laying sequence may be more readily determined for rails with 5" bolt hole centres by use of the graph and tabulations in Fig. 7. An example is given on the graph demonstrating its use.

RE-LAYING GANGS

The strength of re-laying gangs varies usually between 20 and 40 men according to the nature and extent of the work.

Gangs of this size performing different sections of the work over a stretch of track cannot be wholly under the supervisor's constant instruction, and a program of work must be set to ensure that all the men are profitably employed all the time.

To ensure that delays do not occur and that the output of work is fair and reasonable, the trackman-in-charge of the work must be fully competent and must be able to plan out his work ahead of the actual job, in fact, he must be a good organiser.

ORGANISATION

Organisation is a system of delegated powers under various headings with rules and regulations governing the safe and efficient conduct of work or service. As applied to the successful conduct of railway work, organisation may be divided under three broad headings : -

1. Method, i.e., the manner of carrying out the work.
2. Equipment, i.e., the physical utilities whereby the work is effected.
3. Instruction, i.e., the direction of subordinates and the consequent ethical considerations.

METHOD

It is not possible to lay down definite methods of carrying out works under all kinds of varying conditions. The man in charge of the work should by reason of his experience be in the best position to determine how the job should be carried out in the most efficient manner. He should combine a knowledge of trackwork standards with practical experience and ability to apply approved methods to unusual circumstances.

He should not neglect to check over materials and equipment before commencing the work and to plan the order of the work according to local conditions. As far as practicable he should know the ability and shortcomings of the men under his control and allot them duties within their capacity.

He should endeavour to keep an accurate check over the cost of work by measuring up the work periodically and by obtaining man hours incurred, and determining unit costs in all parts of the work and comparing it with his estimates. He must ascertain the cause of any disparity, and where the actual cost is excessive, see that adverse conditions are rectified.

EQUIPMENT

The construction of work of any magnitude and the maintenance thereof necessitates the provision of equipment such as tools and supplies.

The choice of tools and equipment may depend on availability, but it behoves the man in charge to know what tools and plant are obtainable and how to use them to the best advantage.

Carelessness in the use of equipment invariably results in costly repairs and loss of equipment at some important stage of the work, and the efficient supervisor will therefore jealously guard his equipment.

INSTRUCTION

Not the least important phase of organisation is the human relations existing between the supervisor and his men. Human relations rest upon an ethical basis and the aim should be to unite the instructor and the instructed in a bond of service rather than to distinguish each by the measure of his authority or subordination.

Basically considered, all instructions are symbolic, but for the practical purposes of life they are usually grouped under oral, written or printed, and symbolic headings.

Symbolic instructions such as track signs and signals convey warnings and instructions to all concerned. Written or printed instructions should be clear and concise to avoid misapprehension. Oral instructions permit of a choice of language and of manner and, of the two, manner can do more to establish that understanding which should exist between the supervisor and his men.

In dealing with men two broad principles should be kept in mind : -

1. Men must not be considered as machines, but as human beings having like desires as their fellows.
2. As far as it is humanly possible they should be treated justly.

Such treatment demands of each man his best, and that is good and willing service.

The conclusions of 'Camp', an American Engineer who in order to gain experience obtained employment as a track laborer and worked his way up to Roadmaster, are worthy of reprinting from the former V.R.I. Permanent Way papers.

QUOTATIONS FROM 'CAMP'

'Having been a section foreman myself, I cannot resist the temptation to criticise certain defects and odious practices that are more or less widely tolerated or winked at by higher authority.

It is my observation that some foremen are better qualified for the management of a large crew than a small one, for with the small crew they quite overdo the matter of overseeing.

A small crew engaged at ordinary section work, especially if it be made of experienced hands, ought not to call for the continual exercise of the foreman's vocal powers.

Nevertheless there are foremen, often well disposed men too, who seem to take it for granted that every workman needs a certain amount of instruction each day, notwithstanding that the man may be quite familiar with what he is doing. And so instead of leaving a competent man alone and trying to make themselves of some use by their own efforts, as they should, they stand around fretting and actually hindering the work.

Manual labor is not nearly so tiresome to endure as is the habitual fault-finding, irritating lingo of some peevish foreman, for when a man's mind gets tired he feels tired all over. Men working under such oversight will, in time, grow hesitant, lose interest in the work, and strive to do nothing more than to in some way meet the fancy of the 'boss', or else to relieve their minds occasionally by provoking him all they dare. It is only telling the plain truth to say that hard taskmasters are not exceptional among track foremen.

Reference is not here intended to words occasionally spoken in anger, but to the everyday abuse which some foremen heap upon labouring men, who under certain circumstances, perhaps must endure it. Of course, such treatment of men can be regarded only as an indication of shameful ignorance combined with a little authority. Out of lack of confidence in themselves such foremen usually stand in continual dread of losing their positions, and they feel like keeping everyone around them in the same stress of mind.'

Although such demeanour cannot be charged as typical of track foremen as a class, it is nevertheless too largely followed in practice to be overlooked in any general treatment of track labor. It is hardly necessary to add that roadmasters ought not to allow such things to go on. No men working under such foremanship can take a lively interest in the work, and the result is damaging to the company from the dollar-and-cent point of view, even if there be no concern for the inhumanity.

DISCIPLINE. In order to carry on the work of track maintenance to best advantage there must be conformity to well established business principles. The crew should report at the tool house promptly at the time set for starting out in the morning.

The foreman should see that each man does his work thoroughly as well as that he does the proper amount of it. Indeed, at some kinds of work it were as well not to do it at all if it be not well done. The quality of the work is first in importance, the quantity second.

Ordinarily a man should be expected to do a fair day's work, no less, no more. Very truly, the meaning of a 'fair day's work' is something rather indefinite, but the term is generally understood to mean an amount of work performed at such a rate that an average man can keep it up steadily all day long without feeling tired out when night comes.

The judgement of men on this point is quite liable to vary according to their physical endurance; that is, a very strong active man might naturally expect more than would a man of ordinary strength.

Now a good deal of worry and complaint on the part of foremen often arises over the fact that some men are physically able to do far above the average, and a foreman lacking in good judgement will expect that every man in the crew shall keep up with his 'favorite'. Surely this is not fair, and it is very unreasonable.

It is highly important that a foreman should know what an average day's work is. If he has been an observing man he should, from his previous experience, have learned how much of the different kinds of work ordinary men can do, and consequently know what to expect.'

'The best results are turned out by a crew where the men are, as nearly as may be, on a physical equality, provided they do not fall below the average, for men do not usually like to be outdone by others in the crew, and those less able are liable unconsciously to slight their work in order to keep pace with the best. This is liable to occur in packing and it leads to bad results.

Having been a track laborer myself for many years, I will venture a few observations. Some men do better at one kind of work than at another; as for instance, some are not 'built' for grubbing weeds with a shovel, but do well at other kinds of work. And again, some men are naturally a little quicker in their movements than are others. One cannot, therefore, always get men to work alike. As long as a man is doing fairly well he is doing well enough notwithstanding that some other man may be doing a trifle more than he.

A fair-minded foreman can tell when men are making honest effort, and when each succeeds fairly well the foreman should not try to point out inequalities.

Under ordinary circumstances I do not favor the practice of purposely placing men so that their work must show in competition. Such practice in workmen is regarded by some foremen as a smart trick by which the men may be made to feel as though they ought to outdo one another. In some cases of the kind which have come under my observation, however, the aspect of things seemed to indicate that the foreman himself was a little in doubt as to just what he should expect of his men. Under such circumstances the foreman is quite likely to select as a criterion the pace set by some man who is trying to curry his favor.

While temporary results may be accomplished by resort to such tactics nothing worthwhile is gained in the end. The men soon 'catch on' and come to feel that they are distrusted and taken advantage of.

In order to gain speed or make a showing they will slight the quality of the work, and when they engage in work where each man's part does not show for itself they are quite likely to take advantage of the foreman by doing as little as possible without being detected. Thus it goes 'nip and tuck' between the foreman and his crew.'

'Unless employes are encouraged to perform their work in the proper spirit the results are likely to be defective in some respect. But the foreman who understands his business can get the proper amount of work out of his men without setting up a contest among them. A man who cannot keep up a fair rate of work without hurry and worry is not a good man to retain in the service, and neither is he who is continually jumping into the work purposely to show off to disadvantage the work of some other man who is doing enough. Men of the latter class will not always keep up such activity when working alone, for in over-exerting themselves they usually have some particular end in view.'

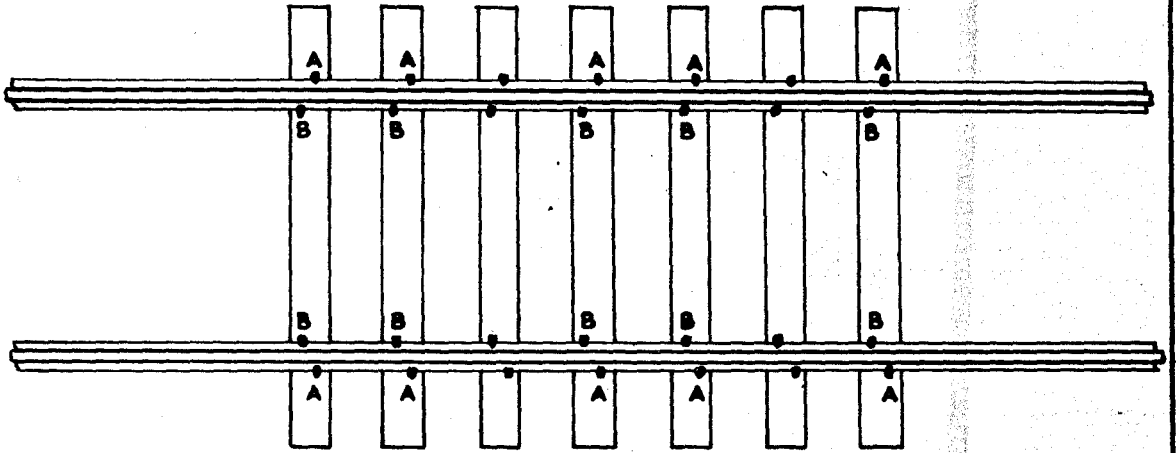

DOGSPIKES TO BE COMPLETELY REMOVED MARKED THUS :- A
 DOGSPIKES TO BE STARTED MARKED THUS :- B

FIG. 1. PREPARATION FOR RELAYING STRAIGHT TRACK

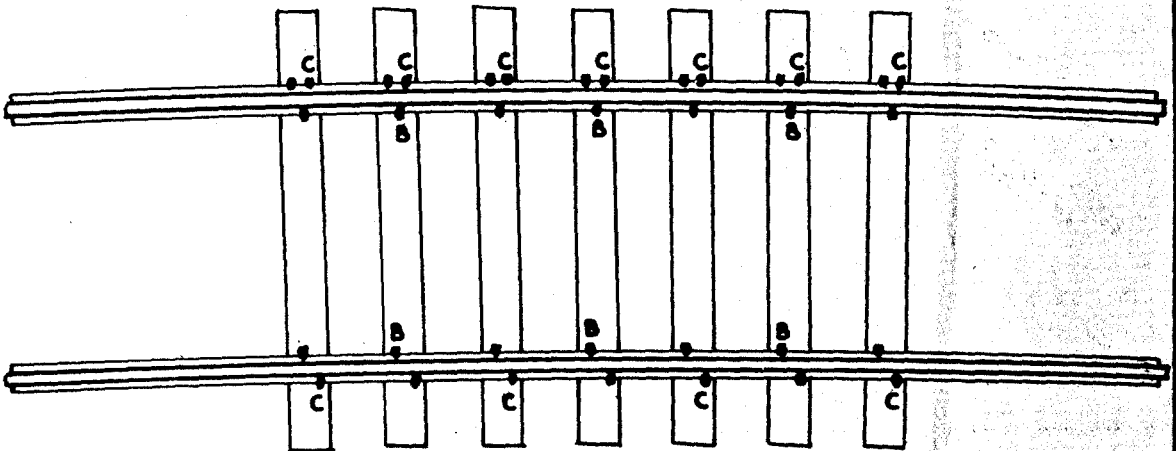

DOGSPIKES TO BE STARTED MARKED THUS :- B
 DOGSPIKES TO BE HALF WITHDRAWN MARKED THUS :- C

FIG. 2. PREPARATION FOR RELAYING CURVED TRACK

RAIL END DOGGED TO SLEEPER

WOODEN BLOCK

STEEL NAILS

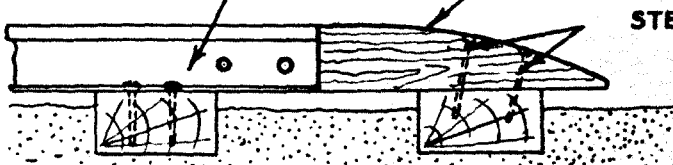

FIG. 3. PROTECTION OF RAIL END BY WOODEN BLOCK

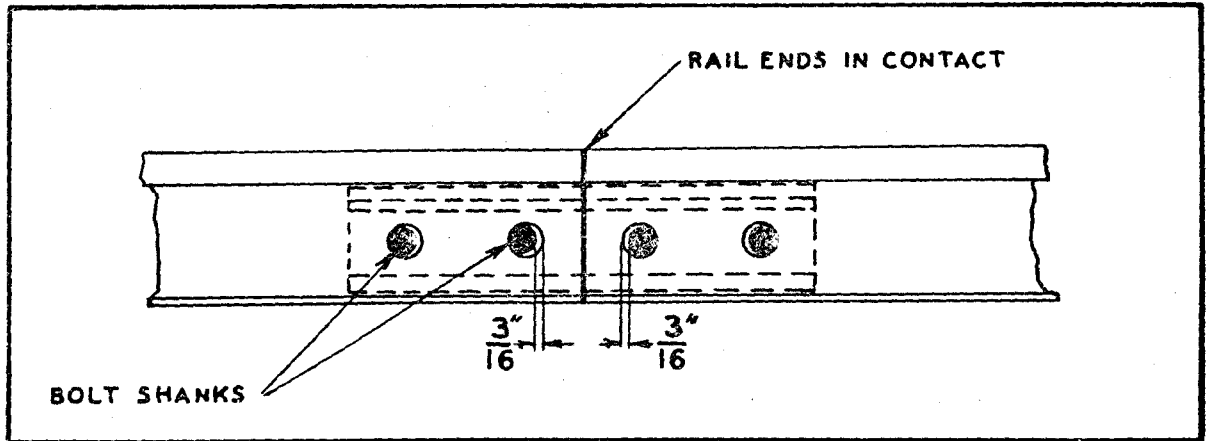

FIG. 4. EXPANSION SPACE, AUST. STANDARD FISHPLATES

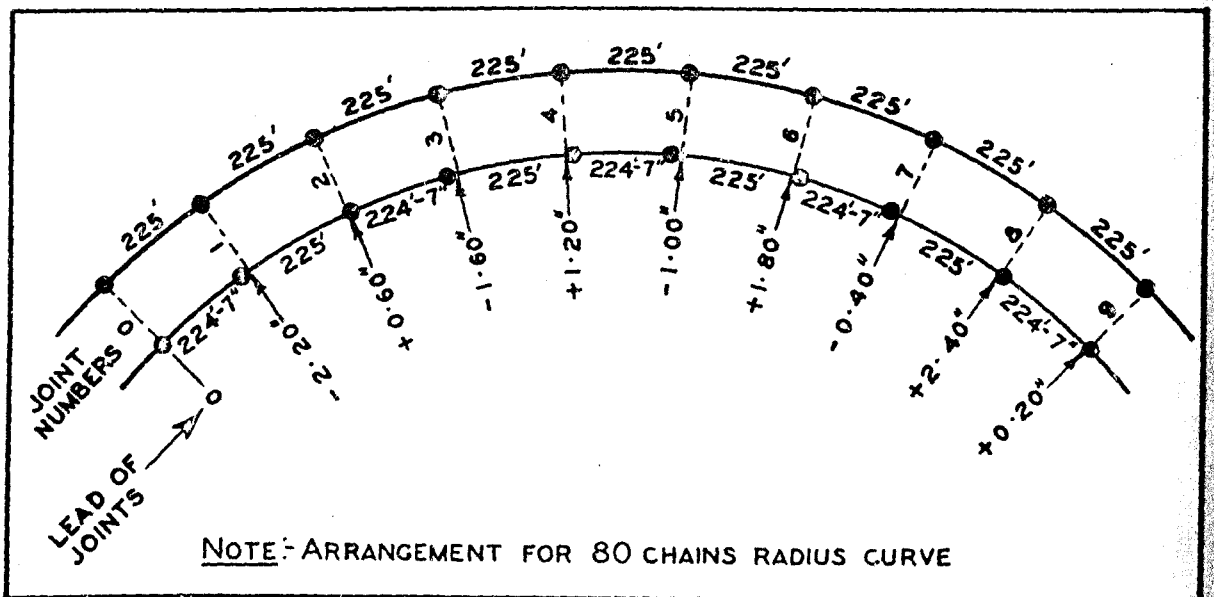

FIG. 5. EXAMPLE OF SHORTENING WELDED RAILS ON CURVES

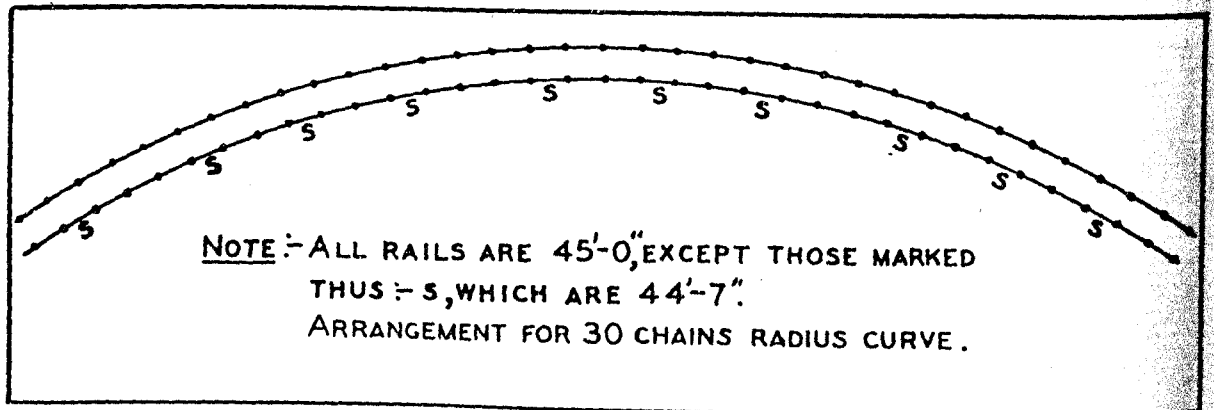
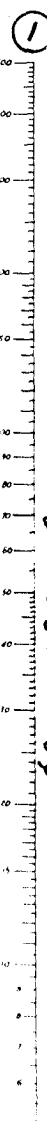

FIG. 6. SHOWING USE OF SHORT RAILS ON CURVES.



①

RADIUS OF CURVE IN CHAINS

②

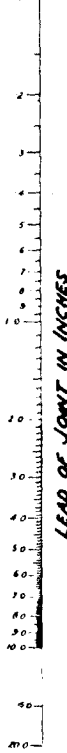

LEAD OF JOINT IN INCHES

③

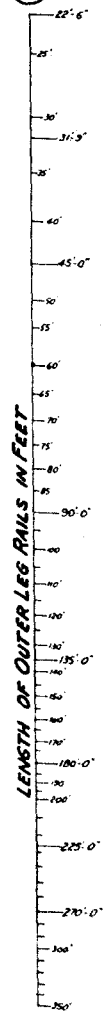

LENGTH OF OUTER LEG RAILS IN FEET

LEAD	LAYING SEQUENCE FOR INNER LEG	A	B	C
0		1	-	1
1	5 1 25 1 5 24 1	50	1	49
2	2 2 2 1 2 1	25	1	24
3	3 3 3 1 3 1	50	2	46
4	4 4 4 1 4 1	25	2	23
5	5 5 5 1 5 1	10	1	9
6	6 6 6 1 6 1	25	3	22
7	7 7 7 1 7 1	50	3	41
8	8 8 8 1 8 1	25	4	39
9	9 9 9 1 9 1	5	1	4
10	10 10 10 1 10 1	50	4	38
11	11 11 11 1 11 1	25	5	36
12	12 12 12 1 12 1	15	3	18
13	13 13 13 1 13 1	25	7	18
14	14 14 14 1 14 1	10	3	7
15	15 15 15 1 15 1	25	8	17
16	16 16 16 1 16 1	50	17	33
17	17 17 17 1 17 1	25	9	16
18	18 18 18 1 18 1	50	18	32
19	19 19 19 1 19 1	5	2	3
20	20 20 20 1 20 1	25	21	29
21	21 21 21 1 21 1	25	11	16
22	22 22 22 1 22 1	50	23	27
23	23 23 23 1 23 1	25	12	15
24	24 24 24 1 24 1	5	1	1
25	25 25 25 1 25 1	25	13	14
26	26 26 26 1 26 1	50	25	25
27	27 27 27 1 27 1	25	14	13
28	28 28 28 1 28 1	50	29	21
29	29 29 29 1 29 1	5	3	2
30	30 30 30 1 30 1	50	32	18
31	31 31 31 1 31 1	25	16	9
32	32 32 32 1 32 1	50	33	17
33	33 33 33 1 33 1	25	17	8
34	34 34 34 1 34 1	10	7	3
35	35 35 35 1 35 1	25	18	7
36	36 36 36 1 36 1	50	37	14
37	37 37 37 1 37 1	25	19	6
38	38 38 38 1 38 1	50	39	11
39	39 39 39 1 39 1	5	4	1
40	40 40 40 1 40 1	50	42	8
41	41 41 41 1 41 1	25	20	3
42	42 42 42 1 42 1	50	43	7
43	43 43 43 1 43 1	25	21	3
44	44 44 44 1 44 1	10	3	1
45	45 45 45 1 45 1	25	22	3
46	46 46 46 1 46 1	50	44	6
47	47 47 47 1 47 1	25	23	3
48	48 48 48 1 48 1	50	46	2
49	49 49 49 1 49 1	25	24	1
50	50 50 50 1 50 1	50	43	1
51	51 51 51 1 51 1	1	1	-

-TABLE 1-

LEAD	INNER LEG RAIL LENGTH 'L' IN TABLE 1	INNER LEG RAIL LENGTH 'S' IN TABLE 1
0 TO 5' 0"	Length of Outer Rail	Length of Outer Rail - 5"
5' 1" TO 10'	Length of Outer Rail - 5"	Length of Outer Rail - 10"

-TABLE 2-

NOTES -

The Columns A, B, C, in Table 1 refer to the number of rails, the number of short rails, and the number of long rails in the series respectively.
 Example on use of Chart - A curve of radius 100 Chains is to be laid with 180 rails on the outer leg. It is required to find the lengths of the rails and the laying sequence for the inner leg. By placing a straight edge on 100 Chains radius, Line 1, and 180 Rail Length, Line 3, the Lead, Line 2, will be seen to be 1'-8". Referring this lead to Table 1, the laying sequence can be found. The rail lengths on the inner leg 'L' & 'S' are found from Table 2. They are 180' and 175'-7" for this example.
 By substituting 180' for 'L' and 175'-7" for 'S' in Table 1, the inner leg will be laid as follows - 180', 175'-7", 180', 180', 173'-7", 180', and so on as shown in Table 1.

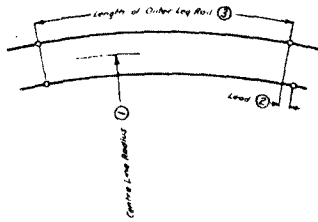

FIG. 7. GRAPH OF LEAD OF JOINTS ETC. ON CURVES



State Library
of Victoria

DOCUMENT SUPPLY & SUPPORT SERVICE

Please note the following:

- This is the best copy available.
- This article has very tight binding.
- Some pages within the original articles are advertisements and have therefore not been sent.
- Some pages within the original are blank and have therefore not been sent.
- This item is being sent by post due to the size / quality of the copy.
- Due to the original being composed of images and text, this is the best copy available.
- This article was originally printed in colour.